

To our customers,

---

## Old Company Name in Catalogs and Other Documents

---

On April 1<sup>st</sup>, 2010, NEC Electronics Corporation merged with Renesas Technology Corporation, and Renesas Electronics Corporation took over all the business of both companies. Therefore, although the old company name remains in this document, it is a valid Renesas Electronics document. We appreciate your understanding.

Renesas Electronics website: <http://www.renesas.com>

April 1<sup>st</sup>, 2010  
Renesas Electronics Corporation

Issued by: Renesas Electronics Corporation (<http://www.renesas.com>)

Send any inquiries to <http://www.renesas.com/inquiry>.

## Notice

1. All information included in this document is current as of the date this document is issued. Such information, however, is subject to change without any prior notice. Before purchasing or using any Renesas Electronics products listed herein, please confirm the latest product information with a Renesas Electronics sales office. Also, please pay regular and careful attention to additional and different information to be disclosed by Renesas Electronics such as that disclosed through our website.
2. Renesas Electronics does not assume any liability for infringement of patents, copyrights, or other intellectual property rights of third parties by or arising from the use of Renesas Electronics products or technical information described in this document. No license, express, implied or otherwise, is granted hereby under any patents, copyrights or other intellectual property rights of Renesas Electronics or others.
3. You should not alter, modify, copy, or otherwise misappropriate any Renesas Electronics product, whether in whole or in part.
4. Descriptions of circuits, software and other related information in this document are provided only to illustrate the operation of semiconductor products and application examples. You are fully responsible for the incorporation of these circuits, software, and information in the design of your equipment. Renesas Electronics assumes no responsibility for any losses incurred by you or third parties arising from the use of these circuits, software, or information.
5. When exporting the products or technology described in this document, you should comply with the applicable export control laws and regulations and follow the procedures required by such laws and regulations. You should not use Renesas Electronics products or the technology described in this document for any purpose relating to military applications or use by the military, including but not limited to the development of weapons of mass destruction. Renesas Electronics products and technology may not be used for or incorporated into any products or systems whose manufacture, use, or sale is prohibited under any applicable domestic or foreign laws or regulations.
6. Renesas Electronics has used reasonable care in preparing the information included in this document, but Renesas Electronics does not warrant that such information is error free. Renesas Electronics assumes no liability whatsoever for any damages incurred by you resulting from errors in or omissions from the information included herein.
7. Renesas Electronics products are classified according to the following three quality grades: “Standard”, “High Quality”, and “Specific”. The recommended applications for each Renesas Electronics product depends on the product’s quality grade, as indicated below. You must check the quality grade of each Renesas Electronics product before using it in a particular application. You may not use any Renesas Electronics product for any application categorized as “Specific” without the prior written consent of Renesas Electronics. Further, you may not use any Renesas Electronics product for any application for which it is not intended without the prior written consent of Renesas Electronics. Renesas Electronics shall not be in any way liable for any damages or losses incurred by you or third parties arising from the use of any Renesas Electronics product for an application categorized as “Specific” or for which the product is not intended where you have failed to obtain the prior written consent of Renesas Electronics. The quality grade of each Renesas Electronics product is “Standard” unless otherwise expressly specified in a Renesas Electronics data sheets or data books, etc.
  - “Standard”: Computers; office equipment; communications equipment; test and measurement equipment; audio and visual equipment; home electronic appliances; machine tools; personal electronic equipment; and industrial robots.
  - “High Quality”: Transportation equipment (automobiles, trains, ships, etc.); traffic control systems; anti-disaster systems; anti-crime systems; safety equipment; and medical equipment not specifically designed for life support.
  - “Specific”: Aircraft; aerospace equipment; submersible repeaters; nuclear reactor control systems; medical equipment or systems for life support (e.g. artificial life support devices or systems), surgical implantations, or healthcare intervention (e.g. excision, etc.), and any other applications or purposes that pose a direct threat to human life.
8. You should use the Renesas Electronics products described in this document within the range specified by Renesas Electronics, especially with respect to the maximum rating, operating supply voltage range, movement power voltage range, heat radiation characteristics, installation and other product characteristics. Renesas Electronics shall have no liability for malfunctions or damages arising out of the use of Renesas Electronics products beyond such specified ranges.
9. Although Renesas Electronics endeavors to improve the quality and reliability of its products, semiconductor products have specific characteristics such as the occurrence of failure at a certain rate and malfunctions under certain use conditions. Further, Renesas Electronics products are not subject to radiation resistance design. Please be sure to implement safety measures to guard them against the possibility of physical injury, and injury or damage caused by fire in the event of the failure of a Renesas Electronics product, such as safety design for hardware and software including but not limited to redundancy, fire control and malfunction prevention, appropriate treatment for aging degradation or any other appropriate measures. Because the evaluation of microcomputer software alone is very difficult, please evaluate the safety of the final products or system manufactured by you.
10. Please contact a Renesas Electronics sales office for details as to environmental matters such as the environmental compatibility of each Renesas Electronics product. Please use Renesas Electronics products in compliance with all applicable laws and regulations that regulate the inclusion or use of controlled substances, including without limitation, the EU RoHS Directive. Renesas Electronics assumes no liability for damages or losses occurring as a result of your noncompliance with applicable laws and regulations.
11. This document may not be reproduced or duplicated, in any form, in whole or in part, without prior written consent of Renesas Electronics.
12. Please contact a Renesas Electronics sales office if you have any questions regarding the information contained in this document or Renesas Electronics products, or if you have any other inquiries.

(Note 1) “Renesas Electronics” as used in this document means Renesas Electronics Corporation and also includes its majority-owned subsidiaries.

(Note 2) “Renesas Electronics product(s)” means any product developed or manufactured by or for Renesas Electronics.

# R8C/Tiny Series

Software Manual

RENESAS 16-BIT SINGLE-CHIP  
MICROCOMPUTER

### Keep safety first in your circuit designs!

1. Renesas Technology Corp. puts the maximum effort into making semiconductor products better and more reliable, but there is always the possibility that trouble may occur with them. Trouble with semiconductors may lead to personal injury, fire or property damage. Remember to give due consideration to safety when making your circuit designs, with appropriate measures such as (i) placement of substitutive, auxiliary circuits, (ii) use of non-flammable material or (iii) prevention against any malfunction or mishap.

### Notes regarding these materials

1. These materials are intended as a reference to assist our customers in the selection of the Renesas Technology Corp. product best suited to the customer's application; they do not convey any license under any intellectual property rights, or any other rights, belonging to Renesas Technology Corp. or a third party.
2. Renesas Technology Corp. assumes no responsibility for any damage, or infringement of any third-party's rights, originating in the use of any product data, diagrams, charts, programs, algorithms, or circuit application examples contained in these materials.
3. All information contained in these materials, including product data, diagrams, charts, programs and algorithms represents information on products at the time of publication of these materials, and are subject to change by Renesas Technology Corp. without notice due to product improvements or other reasons. It is therefore recommended that customers contact Renesas Technology Corp. or an authorized Renesas Technology Corp. product distributor for the latest product information before purchasing a product listed herein. The information described here may contain technical inaccuracies or typographical errors. Renesas Technology Corp. assumes no responsibility for any damage, liability, or other loss rising from these inaccuracies or errors. Please also pay attention to information published by Renesas Technology Corp. by various means, including the Renesas Technology Corp. Semiconductor home page (<http://www.renesas.com>).
4. When using any or all of the information contained in these materials, including product data, diagrams, charts, programs, and algorithms, please be sure to evaluate all information as a total system before making a final decision on the applicability of the information and products. Renesas Technology Corp. assumes no responsibility for any damage, liability or other loss resulting from the information contained herein.
5. Renesas Technology Corp. semiconductors are not designed or manufactured for use in a device or system that is used under circumstances in which human life is potentially at stake. Please contact Renesas Technology Corp. or an authorized Renesas Technology Corp. product distributor when considering the use of a product contained herein for any specific purposes, such as apparatus or systems for transportation, vehicular, medical, aerospace, nuclear, or undersea repeater use.
6. The prior written approval of Renesas Technology Corp. is necessary to reprint or reproduce in whole or in part these materials.
7. If these products or technologies are subject to the Japanese export control restrictions, they must be exported under a license from the Japanese government and cannot be imported into a country other than the approved destination. Any diversion or reexport contrary to the export control laws and regulations of Japan and/or the country of destination is prohibited.
8. Please contact Renesas Technology Corp. for further details on these materials or the products contained therein.

# Using This Manual

This software manual is written for the R8C/Tiny Series. It applies to all microcomputers integrating the R8C/Tiny Series CPU core.

The reader of this manual is assumed to have a basic knowledge of electrical circuits, logic circuits, and microcomputers.

This manual consists of six chapters. The chapters and the subjects they cover are listed below.

- Outline of the R8C/Tiny Series and its features ..... **Chapter 1, “Overview”**
- Operation of addressing modes ..... **Chapter 2, “Addressing Modes”**
- Instruction functions (syntax, operation, function, selectable src/dest (labels), flag changes, description example, related instructions) ..... **Chapter 3, “Functions”**
- Instruction codes and cycles ..... **Chapter 4, “Instruction Codes/Number of Cycles”**
- Instruction interrupts ..... **Chapter 5, “Interrupts”**
- How to calculate the number of cycles ..... **Chapter 6, “Calculating the Number of Cycles”**

This manual also contains quick reference sections immediately following the table of contents. These quick reference sections can be used to rapidly find the pages referring to specific functions, instruction codes, and cycle counts.

- Alphabetic listing by mnemonic ..... **Quick Reference in Alphabetic Order**
- Listing of mnemonics by function ..... **Quick Reference by Function**
- Listing of addressing modes by mnemonic ..... **Quick Reference by Addressing Mode**

A Q&A table, symbols, a glossary, and an index are appended at the end of this manual.

## M16C Family Documents

The following documents were prepared for the M16C family. <sup>(1)</sup>

Document	Contents
Short Sheet	Hardware overview
Data Sheet	Hardware overview and electrical characteristics
Hardware Manual	Hardware specifications (pin assignments, memory maps, peripheral specifications, electrical characteristics, timing charts). *Refer to the application note for how to use peripheral functions.
Software Manual	Detailed description of assembly instructions and microcomputer performance of each instruction
Application Note	<ul style="list-style-type: none"><li>• Usage and application examples of peripheral functions</li><li>• Sample programs</li><li>• Introduction to the basic functions in the M16C family</li><li>• Programming method with Assembly and C languages</li></ul>
RENESAS TECHNICAL UPDATE	Preliminary report about the specification of a product, a document, etc.

### NOTES:

1. Before using this material, please visit the our website to verify that this is the most updated document available.

# Table of Contents

Chapter 1	Overview	
1.1	Features of R8C/Tiny Series	2
1.1.1	Features of R8C/Tiny Series	2
1.1.2	Speed Performance	2
1.2	Address Space	3
1.3	Register Configuration	4
1.3.1	Data registers (R0, R0H, R0L, R1, R1H, R1L, R2, and R3)	4
1.3.2	Address Registers (A0 and A1)	5
1.3.3	Frame Base Register (FB)	5
1.3.4	Program Counter (PC)	5
1.3.5	Interrupt Table Register (INTB)	5
1.3.6	User Stack Pointer (USP) and Interrupt Stack Pointer (ISP)	5
1.3.7	Static Base Register (SB)	5
1.3.8	Flag Register (FLG)	5
1.4	Flag Register (FLG)	6
1.4.1	Bit 0: Carry Flag (C Flag)	6
1.4.2	Bit 1: Debug Flag (D Flag)	6
1.4.3	Bit 2: Zero Flag (Z Flag)	6
1.4.4	Bit 3: Sign Flag (S Flag)	6
1.4.5	Bit 4: Register Bank Select Flag (B Flag)	6
1.4.6	Bit 5: Overflow Flag (O Flag)	6
1.4.7	Bit 6: Interrupt Rnable Flag (I Flag)	6
1.4.8	Bit 7: Stack Pointer Select Flag (U Flag)	6
1.4.9	Bits 8 to 11: Reserved	6
1.4.10	Bits 12 to 14: Processor Interrupt Priority Level (IPL)	7
1.4.11	Bit 15: Reserved	7
1.5	Register Banks	8
1.6	Internal State after Reset is Cleared	9
1.7	Data Types	10
1.7.1	Integer	10
1.7.2	Decimal	11
1.7.3	Bits	12
1.7.4	String	15

1.8 Data Arrangement .....	16
1.8.1 Data Arrangement in Register .....	16
1.8.2 Data Arrangement in Memory .....	17
1.9 Instruction Formats .....	18
1.9.1 Generic Format (:G) .....	18
1.9.2 Quick Format (:Q) .....	18
1.9.3 Short Format (:S) .....	18
1.9.4 Zero Format (:Z) .....	18
1.10 Vector Tables .....	19
1.10.1 Fixed Vector Tables .....	19
1.10.2 Variable Vector Tables .....	20
<b>Chapter 2 Addressing Modes</b> .....	
2.1 Addressing Modes .....	22
2.1.1 General Instruction Addressing .....	22
2.1.2 Special Instruction Addressing .....	22
2.1.3 Bit Instruction Addressing .....	22
2.2 Guide to This Chapter .....	23
2.3 General Instruction Addressing .....	24
2.4 Special Instruction Addressing .....	27
2.5 Bit Instruction Addressing .....	30
<b>Chapter 3 Functions</b> .....	
3.1 Guide to This Chapter .....	34
3.2 Functions .....	39
<b>Chapter 4 Instruction Codes/Number of Cycles</b> .....	
4.1 Guide to This Chapter .....	136
4.2 Instruction Codes/Number of Cycles .....	138
<b>Chapter 5 Interrupts</b> .....	
5.1 Outline of Interrupts .....	246
5.1.1 Types of Interrupts .....	246
5.1.2 Software Interrupts .....	247
5.1.3 Hardware Interrupts .....	248

5.2	Interrupt Control .....	249
5.2.1	I Flag .....	249
5.2.2	IR Bit .....	249
5.2.3	ILVL2 to ILVL0 bis, IPL .....	250
5.2.4	Changing Interrupt Control Register .....	251
5.3	Interrupt Sequence .....	252
5.3.1	Interrupt Response Time .....	253
5.3.2	Changes of IPL When Interrupt Request Acknowledged .....	253
5.3.3	Saving Register Contents .....	254
5.4	Returning from Interrupt Routines .....	255
5.5	Interrupt Priority .....	256
5.6	Multiple Interrupts .....	257
5.7	Note on Interrupts .....	259
5.7.1	Reading Address 0000016 .....	259
5.7.2	SP Setting .....	259
5.7.3	Modifying Interrupt Control Register .....	259
Chapter 6 Calculating the Number of Cycles .....		
6.1	Instruction Queue Buffer .....	262

### Quick Reference in Alphabetic Order

Mnemonic	Page No. for Function	Page No. for Instruction Code /No. of Cycles	Mnemonic	Page No. for Function	Page No. for Instruction Code /No. of Cycles
ABS	39	138	DIVU	68	171
ADC	40	138	DIVX	69	172
ADCF	41	140	DSBB	70	173
ADD	42	140	DSUB	71	175
ADJNZ	44	146	ENTER	72	177
AND	45	147	EXITD	73	178
BAND	47	150	EXTS	74	178
BCLR	48	150	FCLR	75	179
BMCnd	49	152	FSET	76	180
BMEQ/Z	49	152	INC	77	180
BMGE	49	152	INT	78	181
BMGEU/C	49	152	INTO	79	182
BMGT	49	152	<i>JCnd</i>	80	182
BMGTU	49	152	JEQ/Z	80	182
BMLE	49	152	JGE	80	182
BMLEU	49	152	JGEU/C	80	182
BMLT	49	152	JGT	80	182
BMLTU/NC	49	152	JGTU	80	182
BMN	49	152	JLE	80	182
BMNE/NZ	49	152	JLEU	80	182
BMNO	49	152	JLT	80	182
BMO	49	152	JLTU/NC	80	182
BMPZ	49	152	JN	80	182
BNAND	50	153	JNE/NZ	80	182
BNOR	51	154	JNO	80	182
BNOT	52	154	JO	80	182
BNTST	53	155	JPZ	80	182
BNXOR	54	156	JMP	81	183
BOR	55	156	JMPI	82	185
BRK	56	157	JSR	83	187
BSET	57	157	JSRI	84	188
BTST	58	158	LDC	85	189
BTSTC	59	159	LDCTX	86	191
BTSTS	60	160	LDE	87	191
BXOR	61	160	LDINTB	88	192
CMP	62	161	LDIPL	89	193
DADC	64	165	MOV	90	193
DADD	65	167	MOVA	92	200
DEC	66	169			
DIV	67	170			

---

### Quick Reference in Alphabetic Order

Mnemonic	Page No. for Function	Page No. for Instruction Code /No. of Cycles	Mnemonic	Page No. for Function	Page No. for Instruction Code /No. of Cycles
MOV <i>Dir</i>	93	201	ROT	112	220
MOVHH	93	201	RTS	113	221
MOVHL	93	201	SBB	114	222
MOVLH	93	201	SBJNZ	115	224
MOVLL	93	201	SHA	116	225
MUL	94	203	SHL	117	228
MULU	95	205	SMOVB	118	230
NEG	96	207	SMOVF	119	231
NOP	97	207	SSTR	120	231
NOT	98	208	STC	121	232
OR	99	209	STCTX	122	233
POP	101	211	STE	123	233
POPC	102	213	STNZ	124	235
POPM	103	213	STZ	125	235
PUSH	104	214	STZX	126	236
PUSHA	105	216	SUB	127	236
PUSHC	106	216	TST	129	239
PUSHM	107	217	UND	130	241
REIT	108	217	WAIT	131	241
RMPA	109	218	XCHG	132	242
ROLC	110	218	XOR	133	243
RORC	111	219			

## Quick Reference by Function

Function	Mnemonic	Description	Page No. for Function	Page No. for Instruction Code /No. of Cycles
Transfer	MOV	Transfer	90	193
	MOVA	Transfer effective address	92	200
	MOVDir	Transfer 4-bit data	93	201
	POP	Restore register/memory	101	211
	POPM	Restore multiple registers	103	213
	PUSH	Save register/memory/immediate data	104	214
	PUSHA	Save effective address	105	216
	PUSHM	Save multiple registers	107	217
	LDE	Transfer from extended data area	87	191
	STE	Transfer to extended data area	123	233
	STNZ	Conditional transfer	124	235
	STZ	Conditional transfer	125	235
	STZX	Conditional transfer	126	236
	XCHG	Exchange	132	242
Bit manipulation	BAND	Logically AND bits	47	150
	BCLR	Clear bit	48	150
	BM <i>Cnd</i>	Conditional bit transfer	49	152
	BNAND	Logically AND inverted bits	50	153
	BNOR	Logically OR inverted bits	51	154
	BNOT	Invert bit	52	154
	BNTST	Test inverted bit	53	155
	BNXOR	Exclusive OR inverted bits	54	156
	BOR	Logically OR bits	55	156
	BSET	Set bit	57	157
	BTST	Test bit	58	158
	BTSTC	Test bit and clear	59	159
	BTSTS	Test bit and set	60	160
	BXOR	Exclusive OR bits	61	160
Shift	ROL	Rotate left with carry	110	218
	ROR	Rotate right with carry	111	219
	ROT	Rotate	112	220
	SHA	Shift arithmetic	116	215
	SHL	Shift logical	117	228
Arithmetic	ABS	Absolute value	39	138
	ADC	Add with carry	40	138
	ADCF	Add carry flag	41	140
	ADD	Add without carry	42	140
	CMP	Compare	62	161
	DADC	Decimal add with carry	64	165

## Quick Reference by Function

Function	Mnemonic	Description	Page No. for Function	Page No. for Instruction Code /No. of Cycles
Arithmetic	DADD	Decimal add without carry	65	167
	DEC	Decrement	66	169
	DIV	Signed divide	67	170
	DIVU	Unsigned divide	68	171
	DIVX	Signed divide	69	172
	DSBB	Decimal subtract with borrow	70	173
	DSUB	Decimal subtract without borrow	71	175
	EXTS	Extend sign	74	178
	INC	Increment	77	180
	MUL	Signed multiply	94	203
	MULU	Unsigned multiply	95	205
	NEG	Complement of two	96	207
	RMPA	Calculate sum-of-products	109	218
	SBB	Subtract with borrow	114	222
SUB	Subtract without borrow	127	236	
Logical	AND	Logical AND	45	147
	NOT	Invert all bits	98	208
	OR	Logical OR	99	209
	TST	Test	129	239
	XOR	Exclusive OR	133	243
Jump	ADJNZ	Add and conditional jump	44	146
	SBJNZ	Subtract and conditional jump	115	224
	JCnd	Jump on condition	80	182
	JMP	Unconditional jump	81	184
	JMPI	Jump indirect	82	185
	JSR	Subroutine call	83	187
	JSRI	Indirect subroutine call	84	188
	RTS	Return from subroutine	113	221
String	SMOVB	Transfer string backward	118	230
	SMOVF	Transfer string forward	119	231
	SSTR	Store string	120	231
Other	BRK	Debug interrupt	56	157
	ENTER	Build stack frame	72	177
	EXITD	Deallocate stack frame	73	178
	FCLR	Clear flag register bit	75	179
	FSET	Set flag register bit	76	180
	INT	Interrupt by INT instruction	78	181
	INTO	Interrupt on overflow	79	182
	LDC	Transfer to control register	85	189
	LDCTX	Restore context	86	189
	LDINTB	Transfer to INTB register	88	192

---

## Quick Reference by Function

Function	Mnemonic	Description	Page No. for Function	Page No. for Instruction Code /No. of Cycles
Other	LDIPL	Set interrupt enable level	89	193
	NOP	No operation	97	207
	POPC	Restore control register	102	213
	PUSHC	Save control register	106	216
	REIT	Return from interrupt	108	216
	STC	Transfer from control register	121	232
	STCTX	Save context	122	233
	UND	Interrupt for undefined instruction	130	241
WAIT	Wait	131	241	

## Quick Reference by Addressing Mode (General Instruction Addressing)

Mnemonic	Addressing Mode														Page No. for Function	Page No. for Instruction Code /No. of Cycles	
	R0L/R0	R0H/R1	R1L/R2	R1H/R3	An	[An]	dsp:8[An]	dsp:8[SB/FB]	dsp:16[An]	dsp:16[SB]	abs16	#IMM8	#IMM16	#IMM20			#IMM
ABS	○	○	○	○	○	○	○	○	○	○	○					39	138
ADC	○	○	○	○	○	○	○	○	○	○	○	○	○			40	138
ADCF	○	○	○	○	○	○	○	○	○	○	○					41	140
ADD <sup>*1</sup>	○	○	○	○	○	○	○	○	○	○	○	○	○			42	140
ADJNZ <sup>*1</sup>	○	○	○	○	○	○	○	○	○	○	○				○	44	146
AND	○	○	○	○	○	○	○	○	○	○	○	○	○			45	147
CMP	○	○	○	○	○	○	○	○	○	○	○	○	○			62	161
DADC	○	○											○	○		64	165
DADD	○	○											○	○		65	167
DEC	○	○			○							○				66	169
DIV	○	○	○	○	○	○	○	○	○	○	○	○	○			67	170
DIVU	○	○	○	○	○	○	○	○	○	○	○	○	○			68	171
DIVX	○	○	○	○	○	○	○	○	○	○	○	○	○			69	172
DSBB	○	○											○	○		70	173
DSUB	○	○											○	○		71	175
ENTER													○			72	177
EXTS	○		○ <sup>*2</sup>			○	○	○	○	○	○					74	178
INC	○ <sup>*3</sup>	○ <sup>*4</sup>			○			○				○				77	180
INT															○	78	181
JMPI <sup>*1</sup>	○	○	○	○	○	○	○		○	○						82	185
JSRI <sup>*1</sup>	○	○	○	○	○	○	○		○	○						83	187
LDC <sup>*1</sup>	○	○	○	○	○	○	○	○	○	○			○			85	189
LDE <sup>*1</sup>	○	○	○	○	○	○	○	○	○	○						87	191
LDINTB															○	88	192
LDIPL															○	89	193

\*1 Has special instruction addressing.

\*2 Only R1L can be selected.

\*3 Only R0L can be selected.

\*4 Only R0H can be selected.

## Quick Reference by Addressing Mode (General Instruction Addressing)

Mnemonic	Addressing Mode														Page No. for Function	Page No. for Instruction Code /No. of Cycles	
	R0L/R0	R0H/R1	R1L/R2	R1H/R3	An	[An]	dsp:8[An]	dsp:8[SB/FB]	dsp:16[An]	dsp:16[SB]	abs16	#IMM8	#IMM16	#IMM20			#IMM
MOV <sup>*1</sup>	○	○	○	○	○	○	○	○	○	○	○	○	○	○	○	90	193
MOVA	○	○	○	○	○		○	○	○	○	○					92	200
MOV <sub>Dir</sub>	○	○	○	○		○	○	○	○	○	○					93	201
MUL	○	○	○	○	○	○	○	○	○	○	○	○	○			94	203
MULU	○	○	○	○	○	○	○	○	○	○	○	○	○			95	205
NEG	○	○	○	○	○	○	○	○	○	○	○					96	207
NOT	○	○	○	○	○	○	○	○	○	○	○					98	208
OR	○	○	○	○	○	○	○	○	○	○	○	○	○			99	209
POP	○	○	○	○	○	○	○	○	○	○	○					101	211
POPM <sup>*1</sup>	○	○	○	○	○											103	213
PUSH	○	○	○	○	○	○	○	○	○	○	○					104	214
PUSHA							○	○	○	○	○					105	216
PUSHM <sup>*1</sup>	○	○	○	○	○											107	217
ROL	○	○	○	○	○	○	○	○	○	○	○					110	218
ROR	○	○	○	○	○	○	○	○	○	○	○					111	219
ROT	○	○	○	○	○	○	○	○	○	○	○				○	112	220
SBB	○	○	○	○	○	○	○	○	○	○	○	○	○			114	222
SBJNZ <sup>*1</sup>	○	○	○	○	○	○	○	○	○	○	○				○	115	224
SHA <sup>*1</sup>	○	○	○	○	○	○	○	○	○	○	○				○	116	225
SHL <sup>*1</sup>	○	○	○	○	○	○	○	○	○	○	○				○	117	228
STC <sup>*1</sup>	○	○	○	○	○	○	○	○	○	○	○					121	232
STCTX <sup>*1</sup>											○					122	233
STE <sup>*1</sup>	○	○	○	○	○	○	○	○	○	○	○					123	233
STNZ	○	○						○			○	○				124	235
STZ	○	○						○			○	○				125	235

\*1 Has special instruction addressing.

## Quick Reference by Addressing Mode (General Instruction Addressing)

Mnemonic	Addressing Mode														Page No. for Function	Page No. for Instruction Code /No. of Cycles	
	R0L/R0	R0H/R1	R1L/R2	R1H/R3	An	[An]	dsp:8[An]	dsp:8[SB/FB]	dsp:16[An]	dsp:16[SB]	abs16	#IMM8	#IMM16	#IMM20			#IMM
STZX	○	○						○			○	○				126	236
SUB	○	○	○	○	○	○	○	○	○	○	○	○	○			127	236
TST	○	○	○	○	○	○	○	○	○	○	○	○	○			129	239
XCHG	○	○	○	○	○	○	○	○	○	○	○					132	242
XOR	○	○	○	○	○	○	○	○	○	○	○	○	○			133	243

## Quick Reference by Addressing Mode (Special Instruction Addressing)

Mnemonic	Addressing Mode												Page No. for Function	Page No. for Instruction Code /No. of Cycles	
	dsp:20[A0]	dsp:20[A1]	abs20	R2R0/R3R1	A1A0	[A1A0]	dsp:8[SP]	label	SB/FB	ISP/USP	FLG	INTBL/INTBH			PC
ADD <sup>*1</sup>										○				42	140
ADJNZ <sup>*1</sup>								○						44	146
JCnd								○						80	182
JMP			○					○						81	184
JMPI <sup>*1</sup>	○	○		○	○									82	185
JSR			○					○						83	187
JSRI <sup>*1</sup>	○	○		○	○									84	188
LDC <sup>*1</sup>									○	○	○	○		85	189
LDCTX			○											86	189
LDE <sup>*1</sup>	○		○			○								87	191
LDINTB												○ <sup>*2</sup>		88	192
MOV <sup>*1</sup>							○							90	193
POPC									○	○	○	○		102	213
POPM <sup>*1</sup>									○					103	213
PUSHC									○	○	○	○		106	216
PUSHM <sup>*1</sup>									○					107	217
SBJNZ <sup>*1</sup>								○						115	224
SHA <sup>*1</sup>				○										116	225
SHL <sup>*1</sup>				○										117	228
STC <sup>*1</sup>				○	○				○	○	○	○	○	121	232
STCTX <sup>*1</sup>			○											122	233
STE <sup>*1</sup>	○		○			○								123	233

\*1 Has general instruction addressing.

\*2 INTBL and INTBH can be set simultaneously when using the LDINTB instruction.

## Quick Reference by Addressing Mode (Bit Instruction Addressing)

Mnemonic	Addressing Mode										Page No. for Function	Page No. for Instruction Code /No. of Cycles
	bit, Rn	bit, An	[An]	base:8[An]	bit,base:8[SB/FB]	base:16[An]	bit,base:16[SB]	bit,base:16	bit,base:11	U/I/O/B/S/Z/D/C		
BAND	<input type="checkbox"/>	<input type="checkbox"/>	<input type="checkbox"/>	<input type="checkbox"/>	<input type="checkbox"/>	<input type="checkbox"/>	<input type="checkbox"/>	<input type="checkbox"/>	<input type="checkbox"/>	<input type="checkbox"/>	47	150
BCLR	<input type="checkbox"/>	<input type="checkbox"/>	<input type="checkbox"/>	<input type="checkbox"/>	<input type="checkbox"/>	<input type="checkbox"/>	<input type="checkbox"/>	<input type="checkbox"/>	<input type="checkbox"/>	<input type="checkbox"/>	48	150
BM <i>Cnd</i>	<input type="checkbox"/>	<input type="checkbox"/>	<input type="checkbox"/>	<input type="checkbox"/>	<input type="checkbox"/>	<input type="checkbox"/>	<input type="checkbox"/>	<input type="checkbox"/>	<input type="checkbox"/>	<input type="checkbox"/>	49	152
BNAND	<input type="checkbox"/>	<input type="checkbox"/>	<input type="checkbox"/>	<input type="checkbox"/>	<input type="checkbox"/>	<input type="checkbox"/>	<input type="checkbox"/>	<input type="checkbox"/>	<input type="checkbox"/>	<input type="checkbox"/>	50	153
BNOR	<input type="checkbox"/>	<input type="checkbox"/>	<input type="checkbox"/>	<input type="checkbox"/>	<input type="checkbox"/>	<input type="checkbox"/>	<input type="checkbox"/>	<input type="checkbox"/>	<input type="checkbox"/>	<input type="checkbox"/>	21	154
BNOT	<input type="checkbox"/>	<input type="checkbox"/>	<input type="checkbox"/>	<input type="checkbox"/>	<input type="checkbox"/>	<input type="checkbox"/>	<input type="checkbox"/>	<input type="checkbox"/>	<input type="checkbox"/>	<input type="checkbox"/>	52	154
BNTST	<input type="checkbox"/>	<input type="checkbox"/>	<input type="checkbox"/>	<input type="checkbox"/>	<input type="checkbox"/>	<input type="checkbox"/>	<input type="checkbox"/>	<input type="checkbox"/>	<input type="checkbox"/>	<input type="checkbox"/>	53	155
BNXOR	<input type="checkbox"/>	<input type="checkbox"/>	<input type="checkbox"/>	<input type="checkbox"/>	<input type="checkbox"/>	<input type="checkbox"/>	<input type="checkbox"/>	<input type="checkbox"/>	<input type="checkbox"/>	<input type="checkbox"/>	54	156
BOR	<input type="checkbox"/>	<input type="checkbox"/>	<input type="checkbox"/>	<input type="checkbox"/>	<input type="checkbox"/>	<input type="checkbox"/>	<input type="checkbox"/>	<input type="checkbox"/>	<input type="checkbox"/>	<input type="checkbox"/>	55	156
BSET	<input type="checkbox"/>	<input type="checkbox"/>	<input type="checkbox"/>	<input type="checkbox"/>	<input type="checkbox"/>	<input type="checkbox"/>	<input type="checkbox"/>	<input type="checkbox"/>	<input type="checkbox"/>	<input type="checkbox"/>	57	157
BTST	<input type="checkbox"/>	<input type="checkbox"/>	<input type="checkbox"/>	<input type="checkbox"/>	<input type="checkbox"/>	<input type="checkbox"/>	<input type="checkbox"/>	<input type="checkbox"/>	<input type="checkbox"/>	<input type="checkbox"/>	58	158
BTSTC	<input type="checkbox"/>	<input type="checkbox"/>	<input type="checkbox"/>	<input type="checkbox"/>	<input type="checkbox"/>	<input type="checkbox"/>	<input type="checkbox"/>	<input type="checkbox"/>	<input type="checkbox"/>	<input type="checkbox"/>	59	159
BTSTS	<input type="checkbox"/>	<input type="checkbox"/>	<input type="checkbox"/>	<input type="checkbox"/>	<input type="checkbox"/>	<input type="checkbox"/>	<input type="checkbox"/>	<input type="checkbox"/>	<input type="checkbox"/>	<input type="checkbox"/>	60	160
BXOR	<input type="checkbox"/>	<input type="checkbox"/>	<input type="checkbox"/>	<input type="checkbox"/>	<input type="checkbox"/>	<input type="checkbox"/>	<input type="checkbox"/>	<input type="checkbox"/>	<input type="checkbox"/>	<input type="checkbox"/>	61	160
FCLR										<input type="checkbox"/>	75	179
FSET										<input type="checkbox"/>	76	180

---

**This page intentionally left blank.**

# Chapter 1

---

## Overview

- 1.1 Features of R8C/Tiny Series**
- 1.2 Address Space**
- 1.3 Register Configuration**
- 1.4 Flag Register (FLG)**
- 1.5 Register Banks**
- 1.6 Internal State after Reset is Cleared**
- 1.7 Data Types**
- 1.8 Data Arrangement**
- 1.9 Instruction Formats**
- 1.10 Vector Tables**

## 1.1 Features of R8C/Tiny Series

The R8C/Tiny Series of single-chip microcomputers was developed for embedded applications.

The R8C/Tiny Series supports instructions tailored for the C language, with frequently used instructions implemented in one-byte op-code. It thus allows development of efficient programs with reduced memory requirements when using either assembly language or C. Furthermore, some instructions can be executed in a single clock cycle, enabling fast arithmetic processing.

The instruction set comprises 89 discrete instructions matched to the R8C's many addressing modes. This powerful instruction set provides support for register-register, register-memory, and memory-memory operations, as well as arithmetic/logic operations using single-bit and 4-bit data.

Some R8C/Tiny Series models incorporate an on-chip multiplier, allowing for high-speed computation.

### 1.1.1 Features of R8C/Tiny Series

#### ●Register configuration

Data registers: Four 16-bit registers (of which two can be used as 8-bit registers)

Address registers: Two 16-bit registers

Base registers: Two 16-bit registers

#### ●Versatile instruction set

Instructions suited to C language (stack frame manipulation): ENTER, EXITD, etc.

Instructions that do not discriminate by register or memory area MOV, ADD, SUB, etc.

Powerful bit manipulation instructions: BNOT, BTST, BSET, etc.

4-bit transfer instructions: MOVLL, MOVHL, etc.

Frequently used 1-byte instructions: MOV, ADD, SUB, JMP, etc.

High-speed 1-cycle instructions: MOV, ADD, SUB, etc.

#### ●Fast instruction execution time

Minimum 1-cycle instructions: Of 89 instructions, 20 are 1-cycle instructions. (Approximately 75% of instructions execute in five cycles or fewer.)

### 1.1.2 Speed Performance

Register-register transfer 2 cycles

Register-memory transfer 2 cycles

Register-register addition/subtraction 2 cycles

8 bits x 8 bits register-register operation 4 cycles

16 bits x 16 bits register-register operation 5 cycles

16 bits / 8 bits register-register operation 18 cycles

32 bits / 16 bits register-register operation 25 cycles

## 1.2 Address Space

Figure 1.2.1 shows the address space.

Addresses  $00000_{16}$  through  $002FF_{16}$  make up an SFR (special function register) area. In some models in the R8C/Tiny Series, the SFR area extends from  $002FF_{16}$  to lower addresses.

Addresses from  $00400_{16}$  and below make up the memory area. In some models in the R8C/Tiny Series, the RAM area extends from address  $00400_{16}$  to higher addresses, and the ROM area extends from  $0FFFF_{16}$  to lower addresses. Addresses  $0FFDC_{16}$  through  $0FFFF_{16}$  make up a fixed vector area.

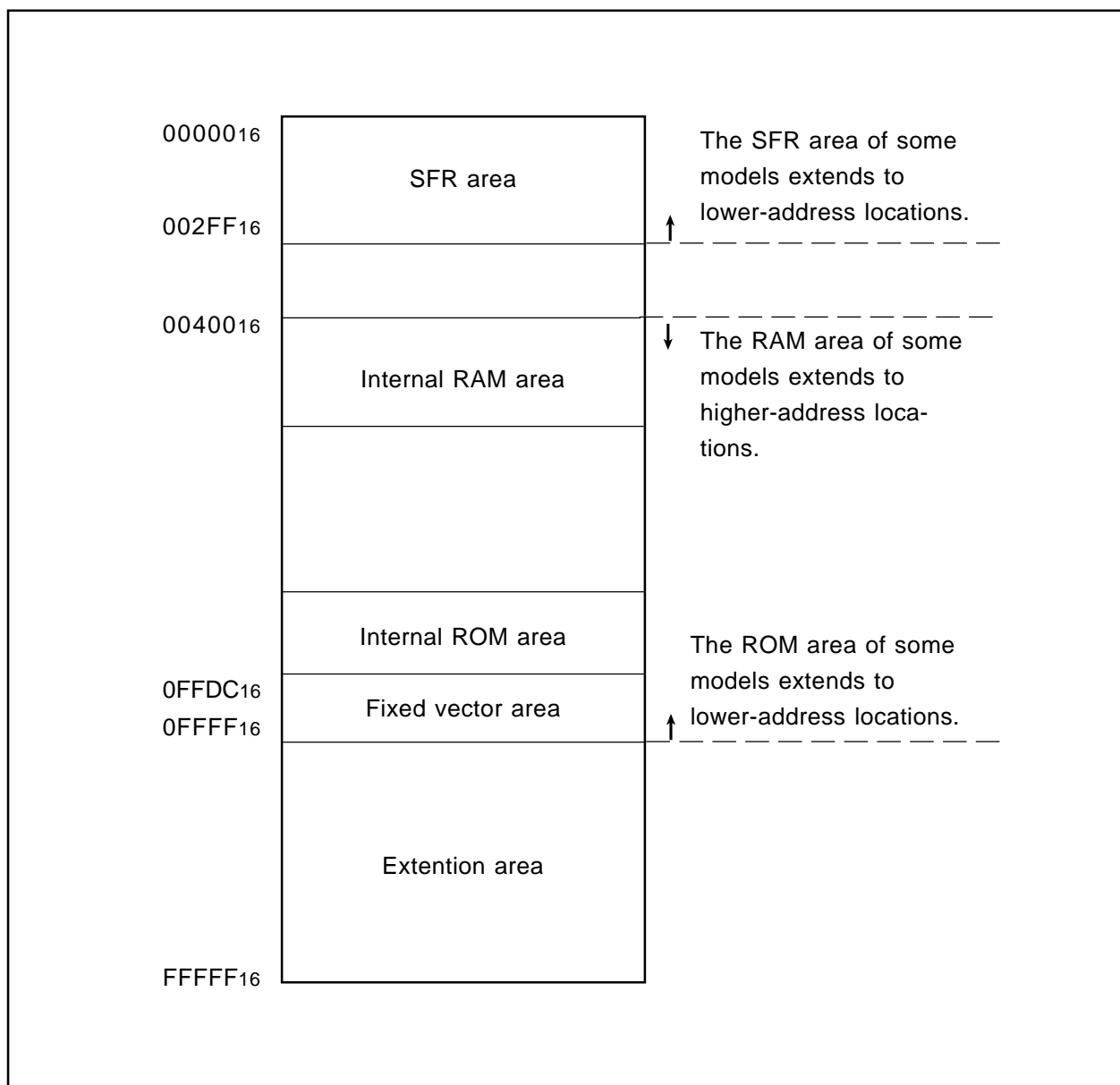

Figure 1.2.1 Address Space

### 1.3 Register Configuration

The central processing unit (CPU) contains the 13 registers shown in figure 1.3.1. Of these registers, R0, R1, R2, R3, A0, A1, and FB each consist of two sets of registers configured as two register banks.

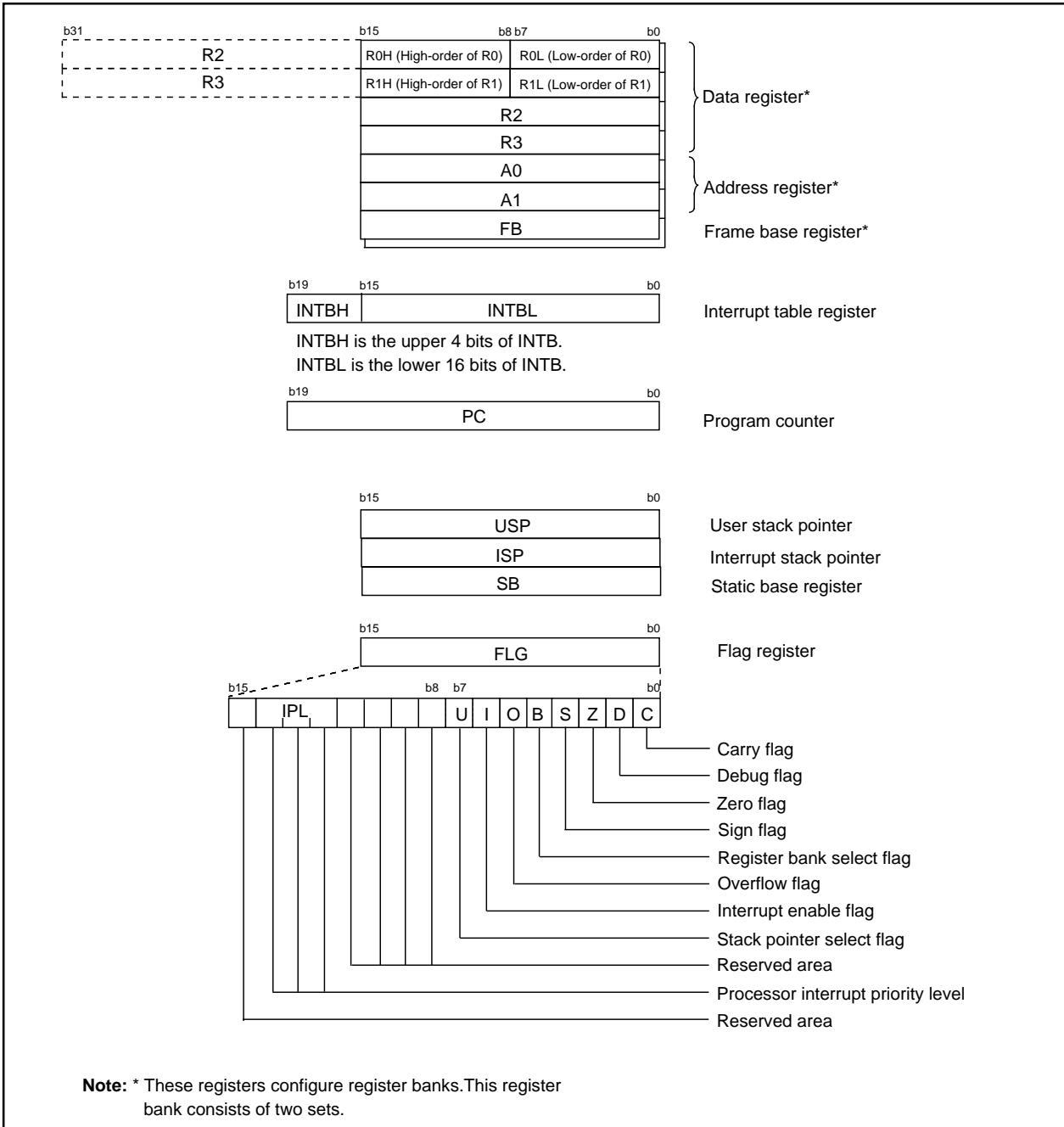

Figure 1.3.1 CPU Register Configuration

#### 1.3.1 Data Registers (R0, R0H, R0L, R1, R1H, R1L, R2, and R3)

The data registers (R0, R1, R2, and R3) each consist of 16 bits and are used primarily for transfers and arithmetic/logic operations.

Registers R0 and R1 can be divided into separate high-order (R0H, R1H) and low-order (R0L, R1L) parts for use as 8-bit data registers. For some instructions, moreover, R2 and R0 or R3 and R1 can be combined to configure a 32-bit data register (R2R0 or R3R1).

### 1.3.2 Address Registers (A0 and A1)

The address registers (A0 and A1) are 16-bit registers with functions similar to those of the data registers. These registers are used for address register-based indirect addressing and address register-based relative addressing.

For some instructions, registers A1 and A0 can be combined to configure a 32-bit address register (A1A0).

### 1.3.3 Frame Base Register (FB)

The frame base register (FB) is a 16-bit register used for FB-based relative addressing.

### 1.3.4 Program Counter (PC)

The program counter (PC) is a 20-bit register that indicates the address of the instruction to be executed next.

### 1.3.5 Interrupt Table Register (INTB)

The interrupt table register (INTB) is a 20-bit register that indicates the initial address of the interrupt vector table.

### 1.3.6 User Stack Pointer (USP) and Interrupt Stack Pointer (ISP)

There are two types of stack pointers: a user stack pointer (USP) and an interrupt stack pointer (ISP). Each consists of 16 bits.

The stack pointer (USP/ISP) to be used can be switched with the stack pointer select flag (U flag).

The stack pointer select flag (U flag) is bit 7 of the flag register (FLG).

### 1.3.7 Static Base Register (SB)

The static base register (SB) is a 16-bit register used for SB-based relative addressing.

### 1.3.8 Flag Register (FLG)

The flag register (FLG) is an 11-bit register used as flags in one-bit units. For details on the functions of the flags, see Section 1.4, “**Flag Register (FLG).**”

## 1.4 Flag Register (FLG)

Figure 1.4.1 shows the configuration of the flag register (FLG). The function of each flag is described below.

### 1.4.1 Bit 0: Carry Flag (C Flag)

This flag holds bits carried, borrowed, or shifted-out by the arithmetic/logic unit.

### 1.4.2 Bit 1: Debug Flag (D Flag)

This flag enables a single-step interrupt.

When this flag is set to 1, a single-step interrupt is generated after an instruction is executed. When the interrupt is acknowledged, the flag is cleared to 0.

### 1.4.3 Bit 2: Zero Flag (Z Flag)

This flag is set to 1 when an arithmetic operation results in 0; otherwise, its value is 0.

### 1.4.4 Bit 3: Sign Flag (S Flag)

This flag is set to 1 when an arithmetic operation results in a negative value; otherwise, its value is 0.

### 1.4.5 Bit 4: Register Bank Select Flag (B Flag)

This flag selects a register bank. If it is set to 0, register bank 0 is selected; if it is set to 1, register bank 1 is selected.

### 1.4.6 Bit 5: Overflow Flag (O Flag)

This flag is set to 1 when an arithmetic operation results in an overflow.

### 1.4.7 Bit 6: Interrupt Enable Flag (I Flag)

This flag enables a maskable interrupt.

When this flag is set to 0, the interrupt is disabled; when it is set to 1, the interrupt is enabled. When the interrupt is acknowledged, the flag is cleared to 0.

### 1.4.8 Bit 7: Stack Pointer Select Flag (U Flag)

When this flag is set to 0, the interrupt stack pointer (ISP) is selected; when it is set to 1, the user stack pointer (USP) is selected.

This flag is cleared to 0 when a hardware interrupt is acknowledged or an INT instruction is executed for software interrupt numbers 0 to 31.

### 1.4.9 Bits 8 to 11: Reserved

**1.4.10 Bits 12 to 14: Processor Interrupt Priority Level (IPL)**

The processor interrupt priority level (IPL) consists of three bits, enabling specification of eight processor interrupt priority levels from level 0 to level 7. If a requested interrupt's priority level is higher than the processor interrupt priority level (IPL), the interrupt is enabled.

**1.4.11 Bit 15: Reserved**

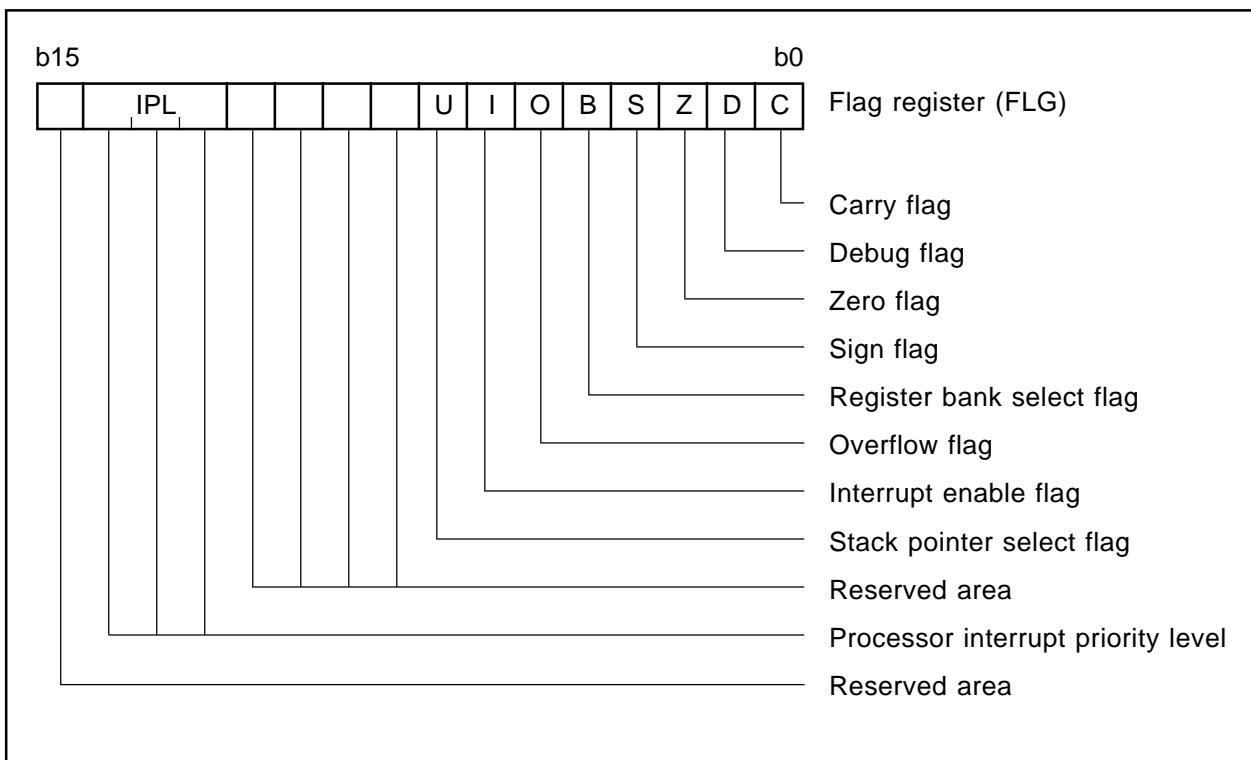

Figure 1.4.1 Configuration of Flag Register (FLG)

## 1.5 Register Banks

The R8C/Tiny has two register banks, each comprising data registers (R0, R1, R2, and R3), address registers (A0 and A1), and a frame base register (FB). These two register banks are switched by the register bank select flag (B flag) in the flag register (FLG).

Figure 1.5.1 shows the configuration of the register banks.

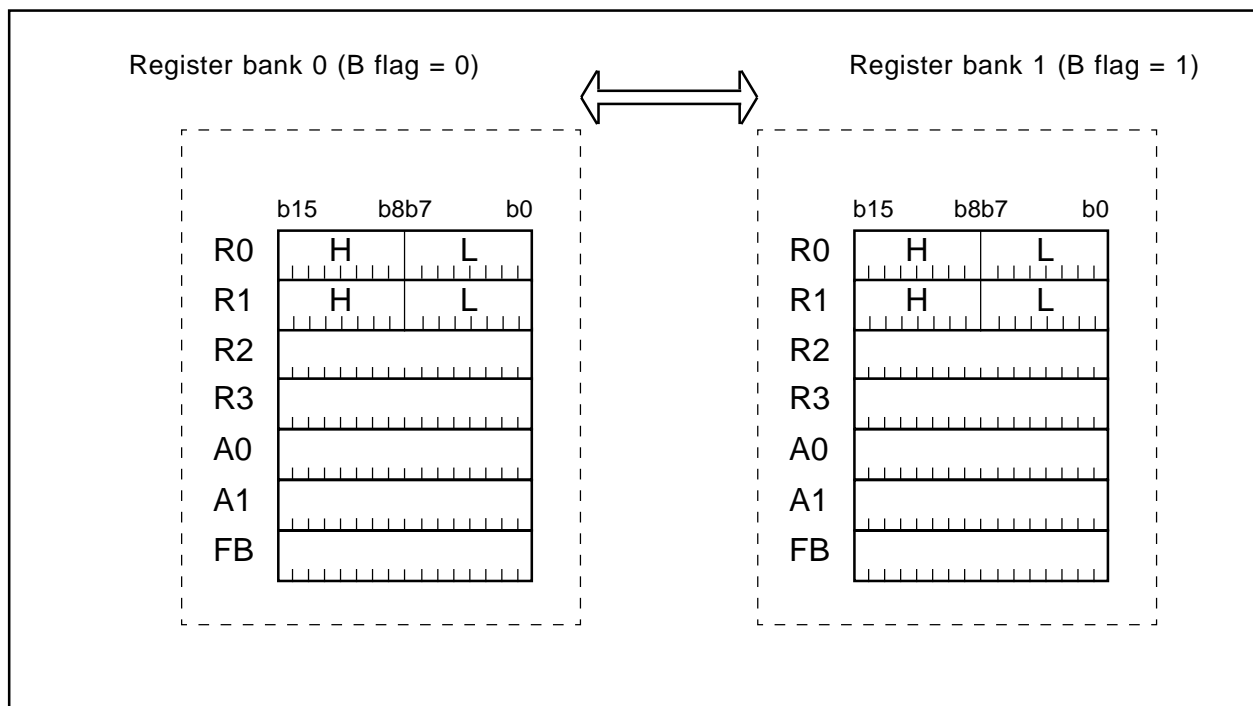

Figure 1.5.1 Configuration of Register Banks

## 1.6 Internal State after Reset is Cleared

The contents of each register after a reset is cleared are as follows.

- Data registers (R0, R1, R2, and R3): 0000<sub>16</sub>
- Address registers (A0 and A1): 0000<sub>16</sub>
- Frame base register (FB): 0000<sub>16</sub>
- Interrupt table register (INTB): 00000<sub>16</sub>
- User stack pointer (USP): 0000<sub>16</sub>
- Interrupt stack pointer (ISP): 0000<sub>16</sub>
- Static base register (SB): 0000<sub>16</sub>
- Flag register (FLG): 0000<sub>16</sub>

## 1.7 Data Types

There are four data types: integer, decimal, bit, and string.

### 1.7.1 Integer

An integer can be signed or unsigned. A negative value of a signed integer is represented by two's complement.

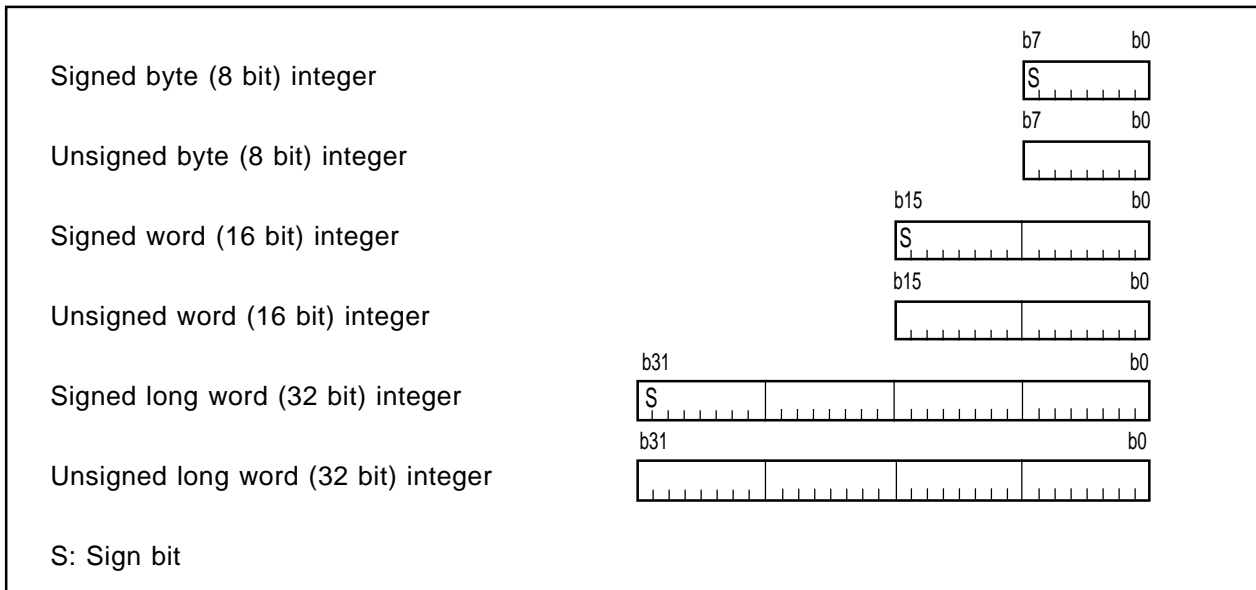

Figure 1.7.1 Integer Data

### 1.7.2 Decimal

The decimal data type is used by the DADC, DADD, DSBB, and DSUB instructions.

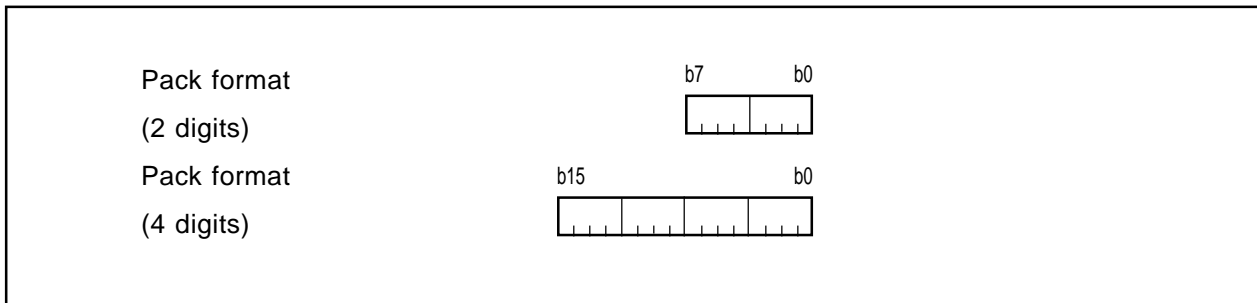

Figure 1.7.2 Decimal Data

### 1.7.3 Bits

#### ●Register bits

Figure 1.7.3 shows register bit specification.

Register bits can be specified by register directly (**bit, Rn** or **bit, An**). Use **bit, Rn** to specify a bit in a data register (**Rn**); use **bit, An** to specify a bit in an address register (**An**).

The bits in each register are assigned bit numbers from 0 to 15, from LSB to MSB. Therefore, **bit, Rn** and **bit, An** can be used to specify a bit number from 0 to 15.

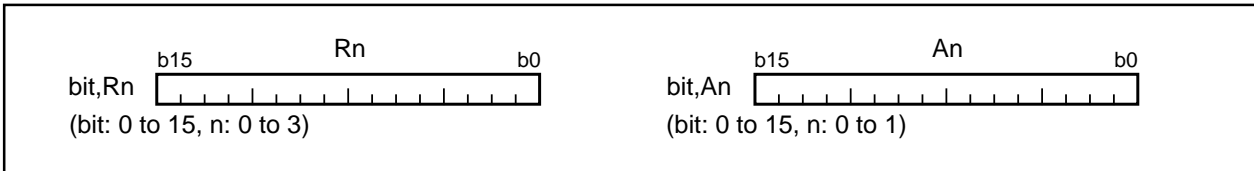

Figure 1.7.3 Register Bit Specification

#### ●Memory bits

Figure 1.7.4 shows the addressing modes used for memory bit specification. Table 1.7.1 lists the address range in which bits can be specified in each addressing mode. Be sure to observe the address range in Table 1.7.1 when specifying memory bits.

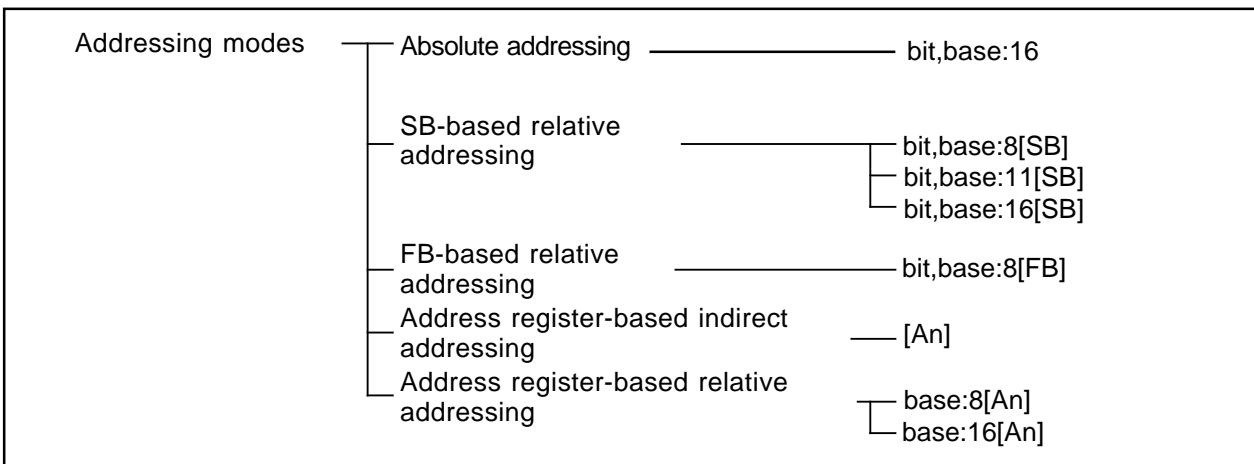

Figure 1.7.4 Addressing Modes Used for Memory Bit Specification

Table 1.7.1 Bit Specification Address Range

Addressing	Specification range		Remarks
	Lower Limit (Address)	Upper Limit (Address)	
bit,base:16	00000 <sub>16</sub>	01FFF <sub>16</sub>	
bit,base:8[SB]	[SB]	[SB]+0001F <sub>16</sub>	The access range is 00000 <sub>16</sub> to 0FFFF <sub>16</sub> .
bit,base:11[SB]	[SB]	[SB]+000FF <sub>16</sub>	The access range is 00000 <sub>16</sub> to 0FFFF <sub>16</sub> .
bit,base:16[SB]	[SB]	[SB]+01FFF <sub>16</sub>	The access range is 00000 <sub>16</sub> to 0FFFF <sub>16</sub> .
bit,base:8[FB]	[FB]-00010 <sub>16</sub>	[FB]+0000F <sub>16</sub>	The access range is 00000 <sub>16</sub> to 0FFFF <sub>16</sub> .
[An]	00000 <sub>16</sub>	01FFF <sub>16</sub>	
base:8[An]	base:8	base:8+01FFF <sub>16</sub>	The access range is 00000 <sub>16</sub> to 020FE <sub>16</sub> .
base:16[An]	base:16	base:16+01FFF <sub>16</sub>	The access range is 00000 <sub>16</sub> to 0FFFF <sub>16</sub> .

### (1) Bit Specification by Bit, Base

Figure 1.7.5 shows the relationship between the memory map and the bit map.

Memory bits can be handled as an array of consecutive bits. Bits can be specified by a combination of **bit** and **base**. Using bit 0 of the address that is set in **base** as the reference (= 0), set the desired bit position in **bit**. Figure 1.7.6 shows examples of how to specify bit 2 of address 0000A16.

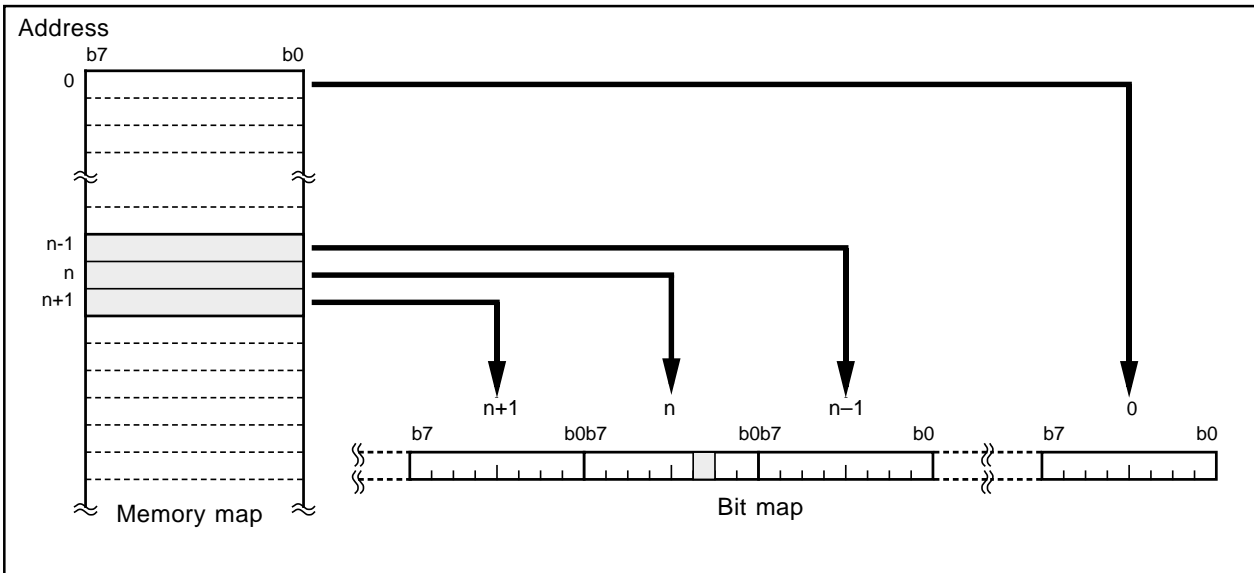

Figure 1.7.5 Relationship between Memory Map and Bit Map

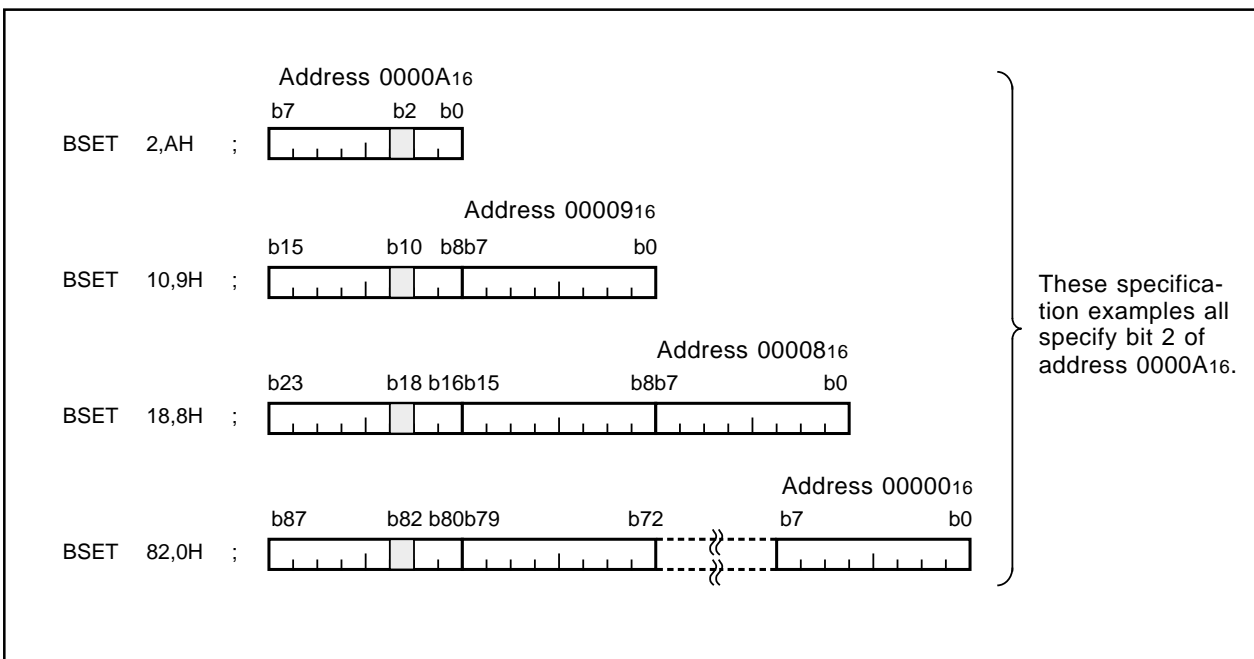

Figure 1.7.6 Examples of How to Specify Bit 2 of Address 0000A16

**(2) SB/FB Relative Bit Specification**

For SB/FB-based relative addressing, use bit 0 of the address that is the sum of the address set in static base register (**SB**) or frame base register (**FB**) plus the address set in **base** as the reference (= 0), and set the desired bit position in **bit**.

**(3) Address Register Indirect/Relative Bit Specification**

For address register-based indirect addressing, use bit 0 of address 00000<sub>16</sub> as the reference (= 0) and set the desired bit position in the address register (**An**).

For address register-based relative addressing, use bit 0 of the address set in **base** as the reference (= 0) and set the desired bit position in the address register (**An**).

### 1.7.4 String

String data consists of a given length of consecutive byte (8-bit) or word (16-bit) data.

This data type can be used in three string instructions: character string backward transfer (SMOVB instruction), character string forward transfer (SMOVF instruction), and specified area initialize (SSTR instruction).

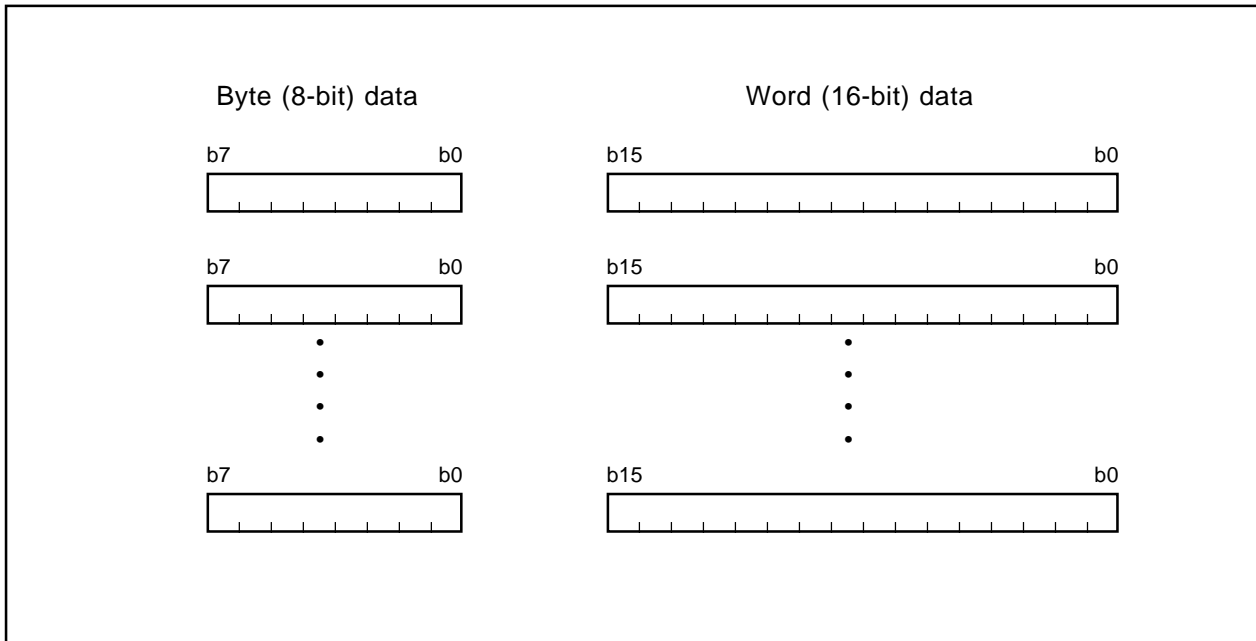

Figure 1.7.7 String Data

## 1.8 Data Arrangement

### 1.8.1 Data Arrangement in Register

Figure 1.8.1 shows the relationship between a register's data size and bit numbers.

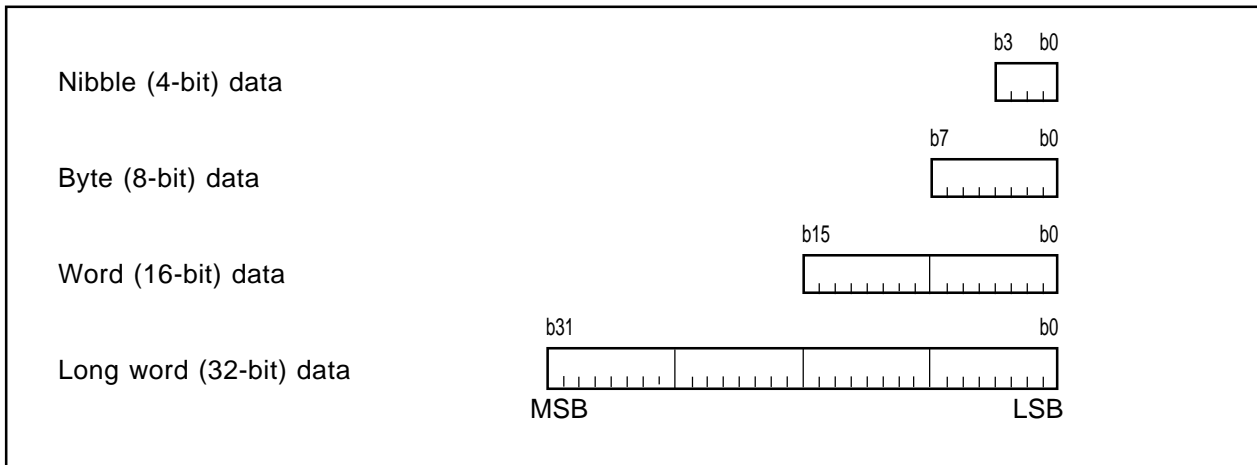

Figure 1.8.1 Data Arrangement in Register

### 1.8.2 Data Arrangement in Memory

Figure 1.8.2 shows the data arrangement in memory. Figure 1.8.3 shows some operation examples.

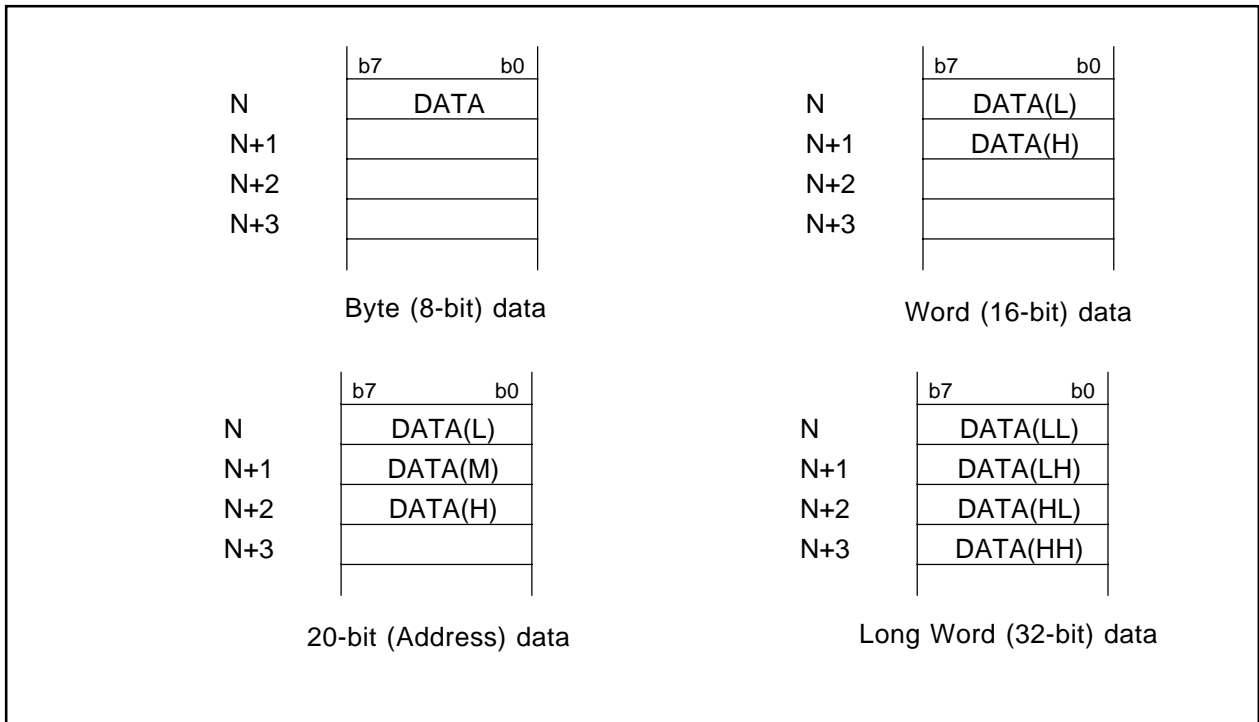

Figure 1.8.2 Data Arrangement in Memory

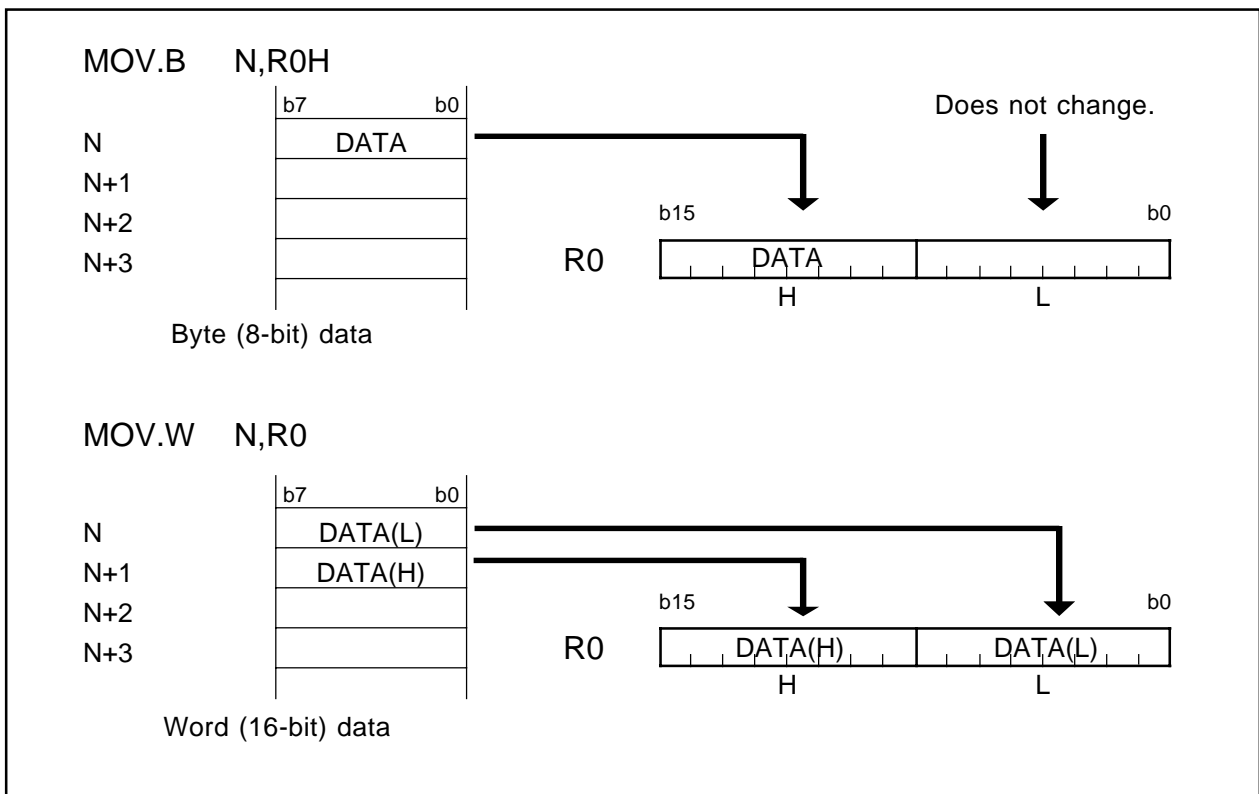

Figure 1.8.3 Operation Examples

## 1.9 Instruction Formats

The instruction formats can be classified into four types: generic, quick, short, and zero. The number of instruction bytes that can be chosen by a given format is least for the zero format, and increases successively for the short, quick, and generic formats, in that order.

The features of each format are described below.

### 1.9.1 Generic Format (:G)

The op-code in this format comprises two bytes. This op-code contains information on the operation and the src<sup>\*1</sup> and dest<sup>\*2</sup> addressing modes.

The instruction code is composed of op-code (2 bytes), src code (0 to 3 bytes), and dest code (0 to 3 bytes).

### 1.9.2 Quick Format (:Q)

The op-code in this format comprises two bytes. This op-code contains information on the operation and the immediate data and dest addressing modes. Note, however, that the immediate data in the op-code is a numeric value that can be expressed as -7 to +8 or -8 to +7 (depending on the instruction).

The instruction code is composed of op-code (2 bytes) containing immediate data and dest code (0 to 2 bytes).

### 1.9.3 Short Format (:S)

The op-code in this format comprises one byte. This op-code contains information on the operation and the src and dest addressing modes. Note, however, that the usable addressing modes are limited.

The instruction code is composed of op-code (1 byte), src code (0 to 2 bytes), and dest code (0 to 2 bytes).

### 1.9.4 Zero Format (:Z)

The op-code in this format comprises one byte. This op-code contains information on the operation (plus immediate data) and dest addressing modes. Note, however, that the immediate data is fixed at 0, and that the usable addressing modes are limited.

The instruction code is composed of op-code (1 byte) and dest code (0 to 2 bytes).

\*1 src is an abbreviation of "source."

\*2 dest is an abbreviation of "destination."

## 1.10 Vector Tables

Interrupt vector tables are the only vector tables. There are two types of interrupt vector tables: fixed and variable.

### 1.10.1 Fixed Vector Tables

A fixed vector table is an address-fixed vector table. Part of the interrupt vector table is allocated to addresses  $0\text{FFDC}_{16}$  through  $0\text{FFFF}_{16}$ . Figure 1.10.1 shows a fixed vector table.

Interrupt vector tables are composed of four bytes per table. Each vector table must contain the interrupt handler routine's entry address.

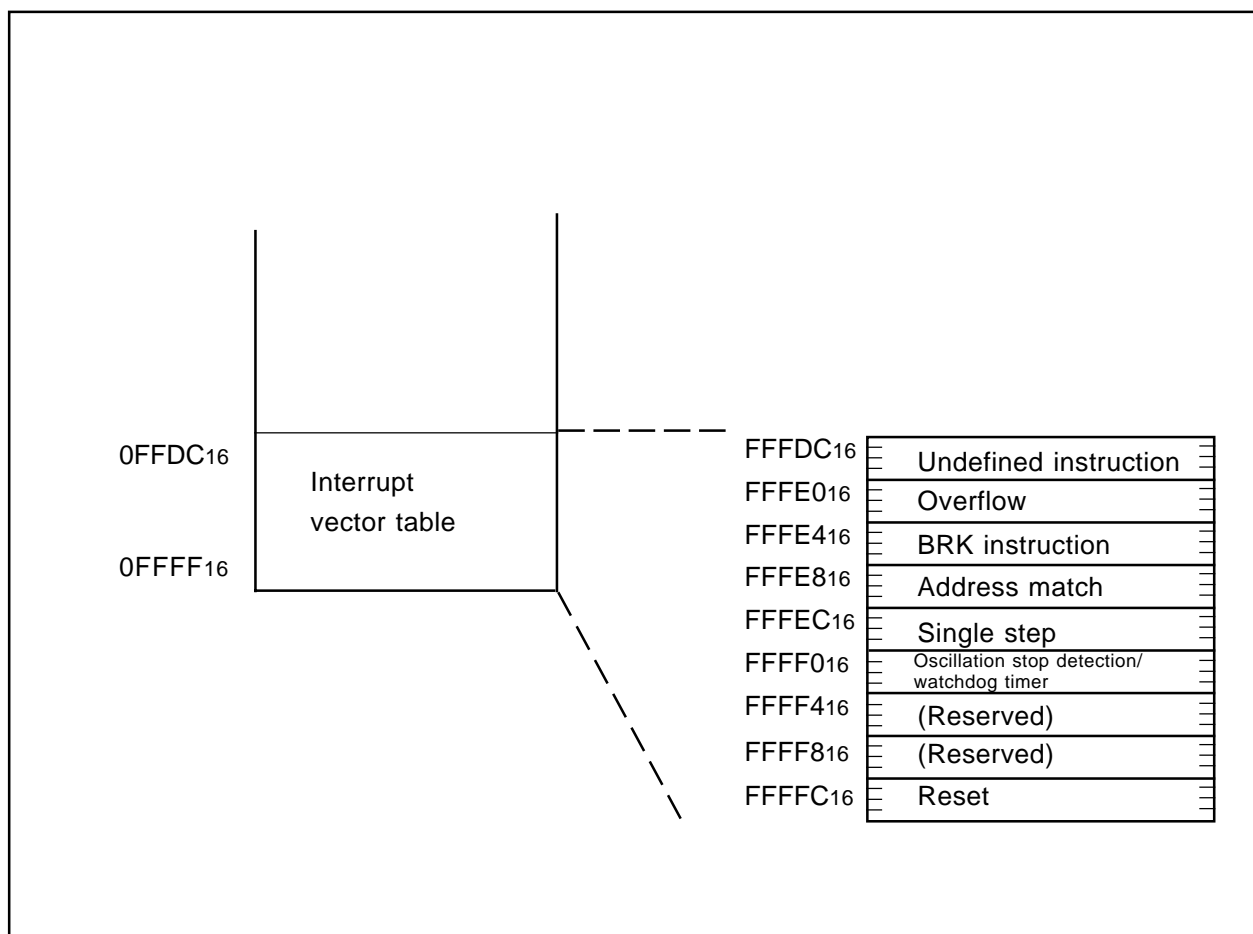

Figure 1.10.1 Fixed Vector Table

### 1.10.2 Variable Vector Tables

A variable vector table is an address-variable vector table. Specifically, this type of vector table is a 256-byte interrupt vector table that uses the value indicated by the interrupt table register (INTB) as the entry address (IntBase). Figure 1.10.2 shows a variable vector table.

Variable vector tables are composed of four bytes per table. Each vector table must contain the interrupt handler routine's entry address.

Each vector table has software interrupt numbers (0 to 63), which are used by the INT instruction.

Interrupts for the on-chip peripheral functions of each M16C model are allocated to software interrupt numbers 0 through 31.

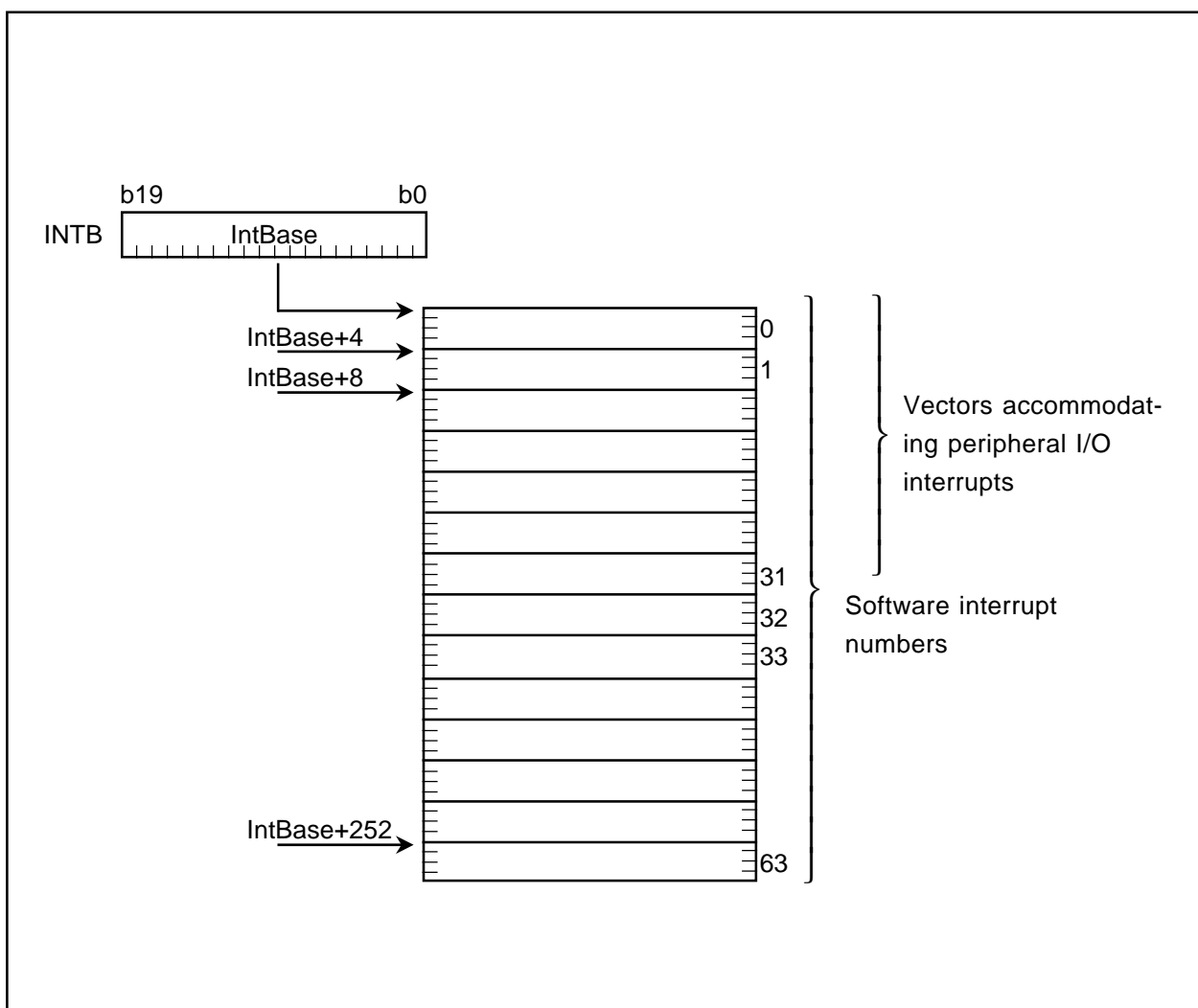

Figure 1.10.2 Variable Vector Table

# Chapter 2

---

## Addressing Modes

- 2.1 Addressing Modes**
- 2.2 Guide to This Chapter**
- 2.3 General Instruction Addressing**
- 2.4 Special Instruction Addressing**
- 2.5 Bit Instruction Addressing**

## 2.1 Addressing Modes

This section describes the symbols used to represent addressing modes and operations of each addressing mode. The R8C/Tiny Series has three types of addressing modes as outlined below.

### 2.1.1 General Instruction Addressing

This addressing mode type accesses the area from address 00000<sub>16</sub> through address 0FFFF<sub>16</sub>.

The names of the general instruction addressing modes are as follows:

- Immediate
- Register direct
- Absolute
- Address register indirect
- Address register relative
- SB relative
- FB relative
- Stack pointer relative

### 2.1.2 Special Instruction Addressing

This addressing mode type accesses the area from address 00000<sub>16</sub> through address FFFFF<sub>16</sub> and the control registers.

The names of the specific instruction addressing modes are as follows:

- 20-bit absolute
- Address register relative with 20-bit displacement
- 32-bit address register indirect
- 32-bit register direct
- Control register direct
- Program counter relative

### 2.1.3 Bit Instruction Addressing

This addressing mode type accesses the area from address 00000<sub>16</sub> through address 0FFFF<sub>16</sub>.

The names of the bit instruction addressing modes are as follows:

- Register direct
- Absolute
- Address register indirect
- Address register relative
- SB relative
- FB relative
- FLG direct

## 2.2 Guide to This Chapter

An example illustrating how to read this chapter is shown below.

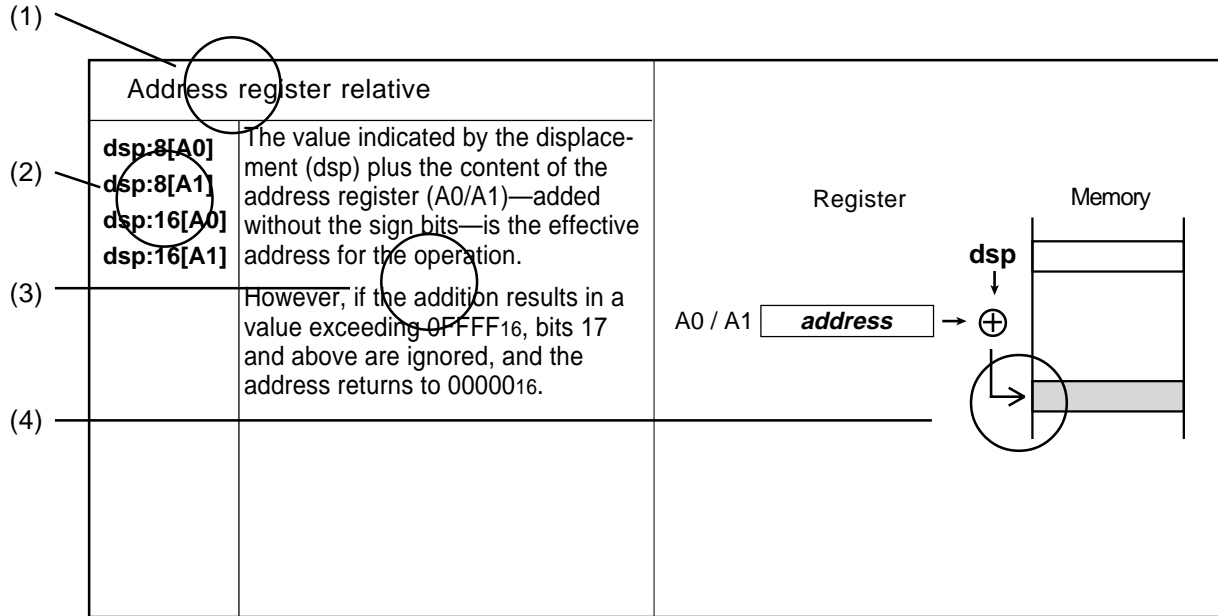

### (1) Name

The name of the addressing mode.

### (2) Symbol

The symbol representing the addressing mode.



### (3) Description

A description of the addressing operation and the effective address range.

### (4) Operation diagram

A diagram illustrating the addressing operation.

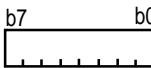
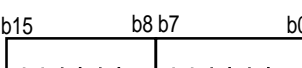
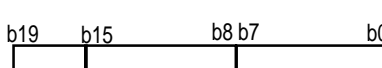
## 2.3 General Instruction Addressing

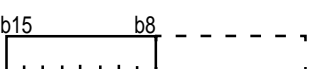
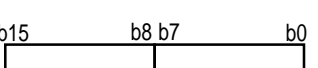
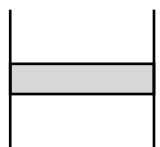
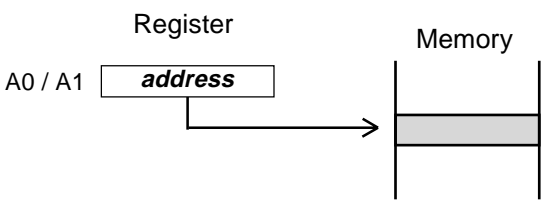
Immediate		
<p><b>#IMM</b>  <b>#IMM8</b>  <b>#IMM16</b>  <b>#IMM20</b></p>	The immediate data indicated by #IMM is the object of the operation.	<p>#IMM8 </p> <p>#IMM16 </p> <p>#IMM20 </p>
Register direct		
<p><b>R0L</b>  <b>R0H</b>  <b>R1L</b>  <b>R1H</b>  <b>R0</b>  <b>R1</b>  <b>R2</b>  <b>R3</b>  <b>A0</b>  <b>A1</b></p>	The specified register is the object of the operation.	<p>Register</p> <p>R0L / R1L </p> <p>R0H / R1H </p> <p>R0 / R1 / R2 / R3 / A0 / A1 </p>
Absolute		
<b>abs16</b>	<p>The value indicated by abs16 is the effective address for the operation.</p> <p>The effective address range is 00000<sub>16</sub> to 0FFFF<sub>16</sub>.</p>	<p>Memory</p> <p>abs16 </p>
Address register indirect		
<b>[A0]</b> <b>[A1]</b>	<p>The value indicated by the content of the address register (A0/A1) is the effective address for the operation.</p> <p>The effective address range is 00000<sub>16</sub> to 0FFFF<sub>16</sub>.</p>	<p>Register</p> <p>A0 / A1 </p> <p>Memory</p>

Address register relative		
<p><b>dsp:8[A0]</b>  <b>dsp:8[A1]</b>  <b>dsp:16[A0]</b>  <b>dsp:16[A1]</b></p>	<p>The value indicated by the displacement (dsp) plus the content of the address register (A0/A1)—added without the sign bits—is the effective address for the operation.</p> <p>However, if the addition results in a value exceeding 0FFFF<sub>16</sub>, bits 17 and above are ignored, and the address returns to 00000<sub>16</sub>.</p>	
SB relative		
<p><b>dsp:8[SB]</b>  <b>dsp:16[SB]</b></p>	<p>The address indicated by the content of the static base register (SB) plus the value indicated by the displacement (dsp)—added without the sign bits—is the effective address for the operation.</p> <p>However, if the addition results in a value exceeding 0FFFF<sub>16</sub>, bits 17 and above are ignored, and the address returns to 00000<sub>16</sub>.</p>	
FB relative		<p>If the dsp value is negative</p> <p>If the dsp value is positive</p>
<p><b>dsp:8[FB]</b></p>	<p>The address indicated by the content of the frame base register (FB) plus the value indicated by the displacement (dsp)—added including the sign bits—is the effective address for the operation.</p> <p>However, if the addition results in a value outside the range 00000<sub>16</sub> to 0FFFF<sub>16</sub>, bits 17 and above are ignored, and the address returns to 00000<sub>16</sub> or 0FFFF<sub>16</sub>.</p>	

Stack pointer relative	
<p><b>dsp:8[SP]</b></p> <p>The address indicated by the content of the stack pointer (SP) plus the value indicated by the displacement (dsp)—added including the sign bits—is the effective address for the operation. The stack pointer (SP) here is the one indicated by the U flag.</p> <p>However, if the addition results in a value outside the range 00000<sub>16</sub> to 0FFFF<sub>16</sub>, bits 17 and above are ignored, and the address returns to 00000<sub>16</sub> or 0FFFF<sub>16</sub>.</p> <p>This addressing mode can be used with the MOV instruction.</p>	

## 2.4 Special Instruction Addressing

20-bit absolute		
<b>abs20</b>	<p>The value indicated by abs20 is the effective address for the operation.</p> <p>The effective address range is 00000<sub>16</sub> to FFFFF<sub>16</sub>.</p> <p>This addressing mode can be used with the LDE, STE, JSR, and JMP instructions.</p>	
Address register relative with 20-bit displacement		<p>○ LDE, STE instructions</p> <p>○ JMPI, JSRI instructions</p>
<b>dsp:20[A0]</b> <b>dsp:20[A1]</b>	<p>The address indicated by the displacement (dsp) plus the content of the address register (A0/A1)—added without the sign bits—is the effective address for the operation.</p> <p>However, if the addition results in a value exceeding FFFFF<sub>16</sub>, bits 21 and above are ignored, and the address returns to 00000<sub>16</sub>.</p> <p>This addressing mode can be used with the LDE, STE, JMPI, and JSRI instructions.</p> <p>Valid addressing mode and instruction combinations are as follows.</p> <p>dsp: 20[A0] → LDE, STE, JMPI, and JSRI instructions</p> <p>dsp: 20[A1] → JMPI and JSRI instructions</p>	
32-bit address register indirect		
<b>[A1A0]</b>	<p>The address indicated by the 32 concatenated bits of the address registers (A0 and A1) is the effective address for the operation.</p> <p>However, if the concatenated register value exceeds FFFFF<sub>16</sub>, bits 21 and above are ignored.</p> <p>This addressing mode can be used with the LDE and STE instructions.</p>	

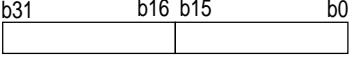
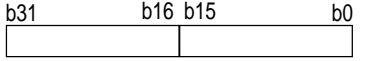
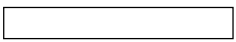
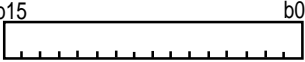
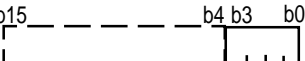
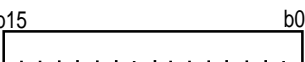
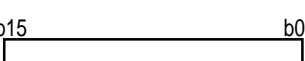
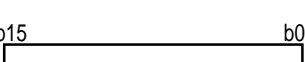
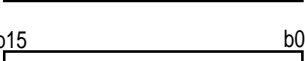
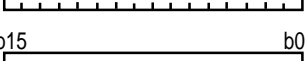
32-bit register direct		<p>○ SHL, SHA instructions</p> <p><b>R2R0</b>    b31                    b16 b15                    b0  </p> <p><b>R3R1</b></p> <p>○ JMPI, JSRI instructions</p> <p><b>R2R0</b>    b31                    b16 b15                    b0  <b>R3R1</b>      <b>A1A0</b>    ↓  <b>PC</b>    </p>
<p><b>R2R0</b> <b>R3R1</b> <b>A1A0</b></p> <p>The 32-bit concatenated register content of two specified registers is the object of the operation.</p> <p>This addressing mode can be used with the SHL, SHA, JMPI, and JSRI instructions.</p> <p>Valid register and instruction combinations are as follows.</p> <p>R2R0, R3R1          → SHL, SHA, JMPI, and JSRI instructions</p> <p>A1A0          → JMPI and JSRI instructions</p>		
Control register direct		<p style="text-align: center;">Register</p> <p><b>INTBL</b>    b15                    b0  </p> <p><b>INTBH</b>    b15                    b4 b3                    b0  </p> <p><b>ISP</b>    b15                    b0  </p> <p><b>USP</b>    b15                    b0  </p> <p><b>SB</b>    b15                    b0  </p> <p><b>FB</b>    b15                    b0  </p> <p><b>FLG</b>    b15                    b0  </p>
<p><b>INTBL</b> <b>INTBH</b> <b>ISP</b> <b>SP</b> <b>SB</b> <b>FB</b> <b>FLG</b></p> <p>The specified control register is the object of the operation.</p> <p>This addressing mode can be used with the LDC, STC, PUSHC, and POPC instructions.</p> <p>If SP is specified, the stack pointer indicated by the U flag is the object of the operation.</p>		

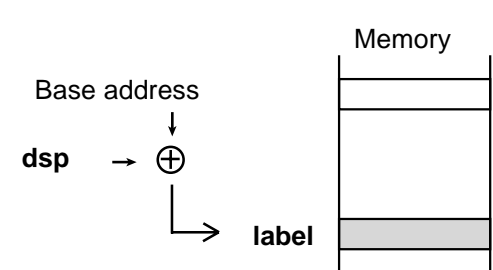
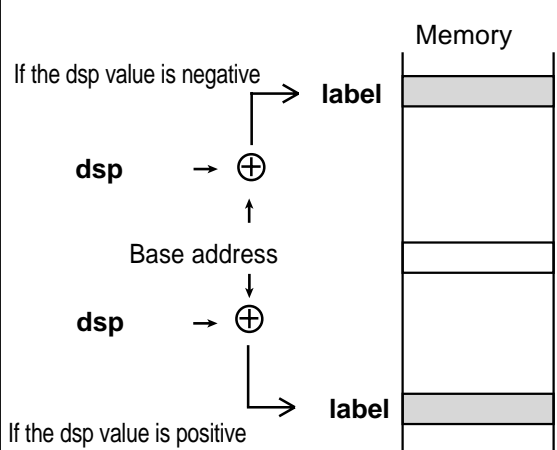
Program counter relative	
<p><b>label</b></p> <ul style="list-style-type: none"> <li>• If the jump length specifier (.length) is (.S), the base address plus the value indicated by the displacement (dsp)—added without the sign bits—is the effective address.</li> </ul> <p>This addressing mode can be used with the JMP instruction.</p>	 <p style="text-align: center;"><math>+0 \leq dsp \leq +7</math></p> <p>*1 The base address is (start address of instruction + 2).</p>
<ul style="list-style-type: none"> <li>• If the jump length specifier (.length) is (.B) or (.W), the base address plus the value indicated by the displacement (dsp)—added including the sign bits—is the effective address.</li> </ul> <p>However, if the addition results in a value outside the range 00000<sub>16</sub> to FFFFF<sub>16</sub>, bits 21 and above are ignored, and the address returns to 00000<sub>16</sub> or FFFFF<sub>16</sub>.</p> <p>This addressing mode can be used with the JMP and JSR instructions.</p>	 <p>If the dsp value is negative</p> <p>If the dsp value is positive</p> <p>If the specifier is (.B), -128 dsp +127          If the specifier is (.W), -32768 dsp +32767</p> <p>*2 The base address varies depending on the instruction.</p>

## 2.5. Bit Instruction Addressing

This addressing mode type can be used with the following instructions: BCLR, BSET, BNOT, BTST, BNTST, BAND, BNAND, BOR, BNOR, BXOR, BNXOR, *BM Cnd*, BTSTS, BTSTC

Register direct		<p><b>bit,R0</b></p> <p>The specified register bit is the object of the operation.</p> <p><b>bit,R1</b></p> <p><b>bit,R2</b></p> <p>A value of 0 to 15 may be specified as the bit position (<b>bit</b>).</p> <p><b>bit,R3</b></p> <p><b>bit,A0</b></p> <p><b>bit,A1</b></p>	<p><b>bit,R0</b></p>
Absolute			
Address register indirect		<p><b>[A0]</b></p> <p><b>[A1]</b></p> <p>The bit that is the number of bits indicated by the address register (A0/A1) away from bit 0 at address 00000<sub>16</sub> is the object of the operation.</p> <p>Bits at addresses 00000<sub>16</sub> through 01FFF<sub>16</sub> can be the object of the operation.</p>	<p>00000<sub>16</sub></p>

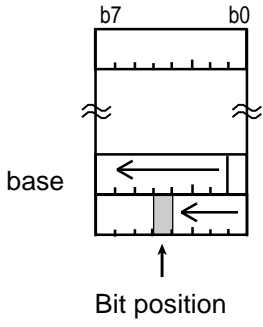
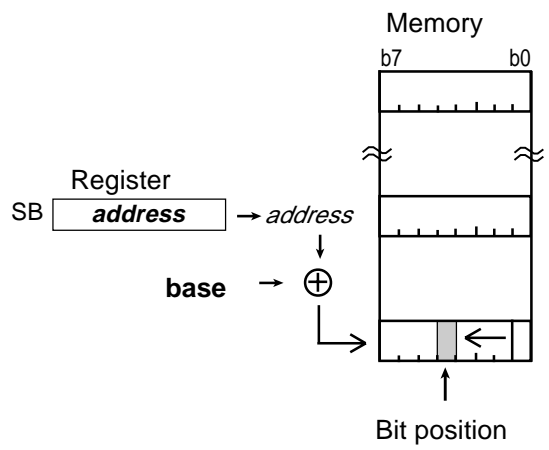
Address register relative		
<p><b>base:8[A0]</b>  <b>base:8[A1]</b>  <b>base:16[A0]</b>  <b>base:16[A1]</b></p>	<p>The bit that is the number of bits indicated by the address register (A0/A1) away from bit 0 at the address indicated by <b>base</b> is the object of the operation.</p> <p>However, if the address of the bit that is the object of the operation exceeds 0FFFF<sub>16</sub>, bits 17 and above are ignored and the address returns to 00000<sub>16</sub>.</p> <p>The address range that can be specified by the address register (A0/A1) extends 8,192 bytes from <b>base</b>.</p>	
SB relative		
<p><b>bit,base:8[SB]</b>  <b>bit,base:11[SB]</b>  <b>bit,base:16[SB]</b></p>	<p>The bit that is the number of bits indicated by <b>bit</b> away from bit 0 at the address indicated by the static base register (SB) plus the value indicated by <b>base</b> (added without the sign bits) is the object of the operation.</p> <p>However, if the address of the bit that is the object of the operation exceeds 0FFFF<sub>16</sub>, bits 17 and above are ignored and the address returns to 00000<sub>16</sub>.</p> <p>The address ranges that can be specified by bit,base:8, bit,base:11, and bit,base:16, respectively, extend 32 bytes, 256 bytes, and 8,192 bytes from the static base register (SB) value.</p>	

<p>FB relative</p>		
<p><b>bit,base:8[FB]</b></p>	<p>The bit that is the number of bits indicated by <b>bit</b> away from bit 0 at the address indicated by the frame base register (FB) plus the value indicated by <b>base</b> (added including the sign bit) is the object of the operation.</p> <p>However, if the address of the bit that is the object of the operation is outside the range 00000<sub>16</sub> to 0FFFF<sub>16</sub>, bits 17 and above are ignored and the address returns to 00000<sub>16</sub> or 0FFFF<sub>16</sub>.</p> <p>The address range that can be specified by bit, base:8 extends 16 bytes toward lower addresses or 15 bytes toward higher addresses from the frame base register (FB) value.</p>	
<p>FLG direct</p>		
<p><b>U I O B S Z D C</b></p>	<p>The specified flag is the object of the operation.</p> <p>This addressing mode can be used with the FCLR and FSET instructions.</p>	

# Chapter 3

---

## Functions

**3.1 Guide to This Chapter**

**3.2 Functions**

### 3.1 Guide to This Chapter

In this chapter each instruction's syntax, operation, function, selectable src/dest, and flag changes are listed, and description examples and related instructions are shown.

An example illustrating how to read this chapter is shown below.

Chapter 3 Functions
3.2 Functions

---

(1) **MOV** *Transfer*

(2) **MOVE** [ Instruction Code/Number of Cycles ]

(3) **MOV.size (:format) src,dest**

**G, Q, Z, S** (Can be specified)  
**B, W**

(4) **[ Operation ]**  
dest ← src

(5) **[ Function ]**

- This instruction transfers *src* to *dest*.
- If *dest* is A0 or A1 and the selected size specifier (.size) is (.B), *src* is zero-expanded to transfer data in 16 bits. If *src* is A0 or A1, the 8 low-order bits of A0 or A1 are transferred.

(6) **[ Selectable src/dest ]** (See next page for src/dest classified by format.)

src				dest			
R0L/R0	R0H/R1	R1L/R2	R1H/R3	R0L/R0	R0H/R1	R1L/R2	R1H/R3
A0/A0	A1/A1	[A0]	[A1]	A0/A0	A1/A1	[A0]	[A1]
dsp:8[A0]	dsp:8[A1]	dsp:8[SB]	dsp:8[FB]	dsp:8[A0]	dsp:8[A1]	dsp:8[SB]	dsp:8[FB]
dsp:16[A0]	dsp:16[A1]	dsp:16[SB]	abs16	dsp:16[A0]	dsp:16[A1]	dsp:16[SB]	abs16
dsp:20[A0]	dsp:20[A1]	abs20	#IMM	dsp:20[A0]	dsp:20[A1]	abs20	
R2R0	R3R1	A1A0	dsp:8[SP]	R2R0	R3R1	A1A0	dsp:8[SP]

(7) **[ Flag Change ]**

Flag	U	I	O	B	S	Z	D	C
Change	—	—	—	—	○	○	—	—

Conditions

S : The flag is set when the transfer results in MSB of dest = 1; otherwise cleared.

Z : The flag is set when the transfer results in 0; otherwise cleared.

(8) **[ Description Example ]**

MOV.B:S #0ABH,R0L

MOV.W #1,R2

(9) **[ Related Instruction ]** LDE, STE, XCHG

**MOV**

Page: 193

---

90

Rev.2.00 Oct 17, 2005 page 34 of 263  
REJ09B0001-0200

**RENESAS**

**(1) Mnemonic**

The mnemonic explained in the page.

**(2) Instruction Code/Number of Cycles**

The page on which the instruction code and number of cycles is listed.

Refer to this page for information on the instruction code and number of cycles.

**(3) Syntax**

The syntax of the instruction using symbols. If (:format) is omitted, the assembler chooses the optimum specifier.

**MOV.size (: format) src , dest**

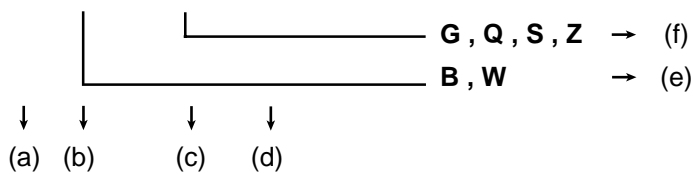

(a) Mnemonic        **MOV**

Shows the mnemonic.

(b) Size specifier    **.size**

Shows the data sizes in which data is handled. The following data sizes may be specified:

.B    Byte (8 bits)

.W    Word (16 bits)

.L    Long word (32 bits)

Some instructions do not have a size specifier.

(c) Instruction format specifier    **(: format)**

Shows the instruction format. If (: format) is omitted, the assembler chooses the optimum specifier.

If (: format) is entered, its content is given priority. The following instruction formats may be specified:

:G    Generic format

:Q    Quick format

:S    Short format

:Z    Zero format

Some instructions do not have an instruction format specifier.

(d) Operands        **src, dest**

Shows the operands.

(e) Shows the data sizes that can be specified in (b).

(f) Shows the instruction formats that can be specified in (c).

Chapter 3 Functions
3.2 Functions

---

(1) **MOV**

(2) [ Syntax ]

(3) **MOV.size (:format) src,dest**

(4) [ Operation ]

(5) [ Function ]

(6) [ Selectable src/dest ]

(7) [ Flag Change ]

(8) [ Description Example ]

(9) [ Related Instruction ]

*Transfer*  
**MOVE**

[ Instruction Code/Number of Cycles ]

Page: 193

**MOV**

G, Q, Z, S (Can be specified)  
B, W

dest ← src

- This instruction transfers *src* to *dest*.
- If *dest* is A0 or A1 and the selected size specifier (.size) is (.B), *src* is zero-expanded to transfer data in 16 bits. If *src* is A0 or A1, the 8 low-order bits of A0 or A1 are transferred.

(See next page for src/dest classified by format.)

src				dest			
R0L/R0	R0H/R1	R1L/R2	R1H/R3	R0L/R0	R0H/R1	R1L/R2	R1H/R3
A0/A0	A1/A1	[A0]	[A1]	A0/A0	A1/A1	[A0]	[A1]
dsp:8[A0]	dsp:8[A1]	dsp:8[SB]	dsp:8[FB]	dsp:8[A0]	dsp:8[A1]	dsp:8[SB]	dsp:8[FB]
dsp:16[A0]	dsp:16[A1]	dsp:16[SB]	abs16	dsp:16[A0]	dsp:16[A1]	dsp:16[SB]	abs16
dsp:20[A0]	dsp:20[A1]	abs20	#IMM	dsp:20[A0]	dsp:20[A1]	abs20	
R2R0	R3R1	A1A0	dsp:8[SP]	R2R0	R3R1	A1A0	dsp:8[SP]

Flag	U	I	O	B	S	Z	D	C
Change	—	—	—	—	○	○	—	—

Conditions

S : The flag is set when the transfer results in MSB of dest = 1; otherwise cleared.

Z : The flag is set when the transfer results in 0; otherwise cleared.

MOV.B:S #0ABH,R0L  
MOV.W # -1,R2

LDE, STE, XCHG

---

90

**(4) Operation**

Explains the operation of the instruction using symbols.

**(5) Function**

Explains the function of the instruction and precautions to be taken when using the instruction.

**(6) Selectable *src* / *dest* (label)**

If the instruction has operands, the valid formats are listed here.

<b>src</b>				<b>dest</b>			
R0L/R0	R0H/R1	R1L/R2	R1H/R3	R0L/R0	R0H/R1	R1L/R2	R1H/R3
A0/A0	A1/A1	[A0]	[A1]	A0/A0	A1/A1	[A0]	[A1]
dsp:8[A0]	dsp:8[A1]	dsp:8[SB]	dsp:8[FB]	dsp:8[A0]	dsp:8[A1]	dsp:8[SB]	dsp:8[FB]
dsp:16[A0]	dsp:16[A1]	dsp:16[SB]	abs16	dsp:16[A0]	dsp:16[A1]	dsp:16[SB]	abs16
dsp:20[A0]	dsp:20[A1]	abs20	#IMM	dsp:20[A0]	dsp:20[A1]	abs20	
R2R0	R3R1	A1A0	dsp:8[SP]	R2R0	R3R1	A1A0	dsp:8[SP]

- (a) Items that can be selected as *src* (source)
- (b) Items that can be selected as *dest* (destination)
- (c) Addressing modes that can be selected
- (d) Addressing modes that cannot be selected
- (e) Shown on the left side of the slash (R0H) is the addressing mode when data is handled in bytes (8 bits).  
Shown on the right side of the slash (R1) is the addressing mode when data is handled in words (16 bits).

**(7) Flag change**

Shows a flag change that occurs after the instruction is executed. The symbols in the table mean the following.

- “\_” The flag does not change.
- “O” The flag changes depending on a condition.

**(8) Description example**

Description examples for the instruction.

**(9) Related instructions**

Related instructions that cause an operation similar or opposite to that of the instruction.

The syntax of the jump instructions JMP, JPML, JSR, and JSRI are illustrated below by example .

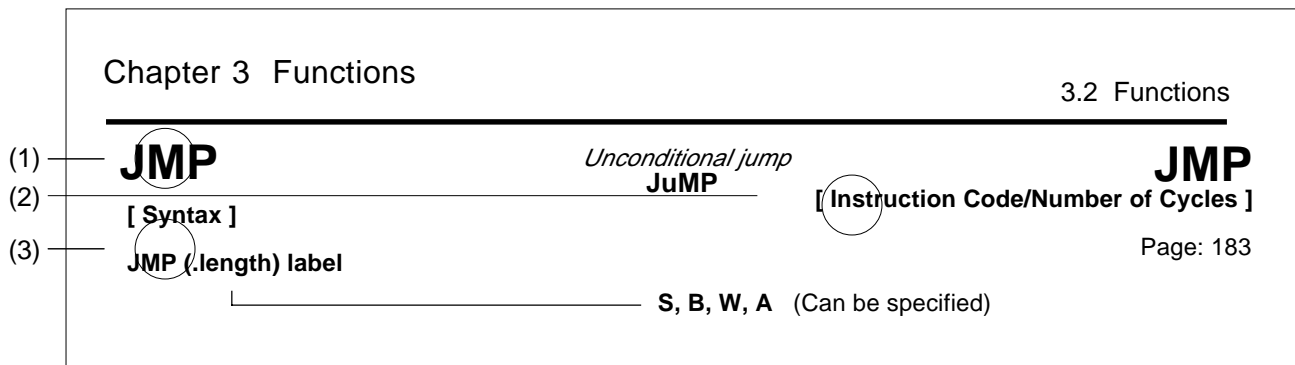

### (3) Syntax

Indicates the instruction syntax using symbols.

**JMP (.length) label**

S, B, W, A → (d)

↓   ↓   ↓

(a) (b) (c)

(a) Mnemonic      **JMP**  
Shows the mnemonic.

(b) Jump distance specifier      **.length**  
Shows the distance of the jump. If (.length) is omitted from the JMP or JSR instruction, the assembler chooses the optimum specifier. If (.length) is entered, its content is given priority.

The following jump distances may be specified:

- .S    3-bit PC forward relative (+2 to +9)
- .B    8-bit PC relative
- .W    16-bit PC relative
- .A    20-bit absolute

(c) Operand      **label**  
Shows the operand.

(d) Shows the jump distances that can be specified in (b).

# ABS

*Absolute value*  
**ABSolute**

# ABS

**[ Syntax ]**

ABS.size    dest  
 └──────────────────────────┘ B, W

**[ Instruction Code/Number of Cycles ]**

Page: 138

**[ Operation ]**

dest ← | dest |

**[ Function ]**

- This instruction takes the absolute value of *dest* and stores it in *dest*.

**[ Selectable dest ]**

dest			
R0L/R0	R0H/R1	R1L/R2	R1H/R3
A0/A0	A1/A1	[A0]	[A1]
dsp:8[A0]	dsp:8[A1]	dsp:8[SB]	dsp:8[FB]
dsp:16[A0]	dsp:16[A1]	dsp:16[SB]	abs16
dsp:20[A0]	dsp:20[A1]	abs20	
R2R0	R3R1	A1A0	

**[ Flag Change ]**

Flag	U	I	O	B	S	Z	D	C
Change	—	—	○	—	○	○	—	○

Conditions

- O : The flag is set (= 1) when dest before the operation is -128 (.B) or -32768 (.W); otherwise cleared (= 0).
- S : The flag is set when the operation results in MSB = 1; otherwise cleared.
- Z : The flag is set when the operation results in 0; otherwise cleared.
- C : The flag value is undefined.

**[ Description Example ]**

ABS.B    R0L  
 ABS.W    A0



# ADCF

## Add carry flag ADDITION Carry Flag

# ADCF

**[ Syntax ]**

ADCF.size    dest  
 └──────────────────────────────────┘  
 B , W

**[ Instruction Code/Number of Cycles ]**

Page: 140

**[ Operation ]**

$$\text{dest} \leftarrow \text{dest} + \text{C}$$
**[ Function ]**

This instruction adds *dest* and the C flag and stores the result in *dest*.

**[ Selectable dest ]**

dest			
R0L/R0	R0H/R1	R1L/R2	R1H/R3
A0/A0	A1 A1	[A0]	[A1]
dsp:8[A0]	dsp:8[A1]	dsp:8[SB]	dsp:8[FB]
dsp:16[A0]	dsp:16[A1]	dsp:16[SB]	abs16
dsp:20[A0]	dsp:20[A1]	abs20	
R2R0	R3R1	A1A0	

**[ Flag Change ]**

Flag	U	I	O	B	S	Z	D	C
Change	—	—	○	—	○	○	—	○

## Conditions

- O : The flag is set when a signed operation results in a value exceeding +32767 (.W) or -32768 (.W) or +127 (.B) or -128 (.B); otherwise cleared.
- S : The flag is set when the operation results in MSB = 1; otherwise cleared.
- Z : The flag is set when the operation results in 0; otherwise cleared.
- C : The flag is set when an unsigned operation results in a value exceeding +65535 (.W) or +255 (.B); otherwise cleared.

**[ Description Example ]**

ADCF.B    R0L  
 ADCF.W    Ram:16[A0]

**[ Related Instructions ]**    ADC, ADD, SBB, SUB

# ADD

Add without carry  
**ADDITION**

# ADD

**[ Syntax ]**

**[ Instruction Code/Number of Cycles ]**

ADD.size (:format) src,dest  
 \_\_\_\_\_ G , Q , S (Can be specified)  
 \_\_\_\_\_ B , W

Page: 140

**[ Operation ]**

dest ← dest + src

**[ Function ]**

- This instruction adds *dest* and *src* and stores the result in *dest*.
- If *dest* is A0 or A1 and the selected size specifier (.size) is (.B), *src* is zero-expanded to perform calculation in 16 bits. If *src* is A0 or A1, the operation is performed on the eight low-order bits of A0 or A1.
- If *dest* is a stack pointer and the selected size specifier (.size) is (.B), *src* is sign extended to perform calculation in 16 bits.

**[ Selectable src/dest ]**

(See next page for *src/dest* classified by format.)

src				dest			
R0L/R0	R0H/R1	R1L/R2	R1H/R3	R0L/R0	R0H/R1	R1L/R2	R1H/R3
A0/A0 <sup>*1</sup>	A1/A1 <sup>*1</sup>	[A0]	[A1]	A0/A0 <sup>*1</sup>	A1/A1 <sup>*1</sup>	[A0]	[A1]
dsp:8[A0]	dsp:8[A1]	dsp:8[SB]	dsp:8[FB]	dsp:8[A0]	dsp:8[A1]	dsp:8[SB]	dsp:8[FB]
dsp:16[A0]	dsp:16[A1]	dsp:16[SB]	abs16	dsp:16[A0]	dsp:16[A1]	dsp:16[SB]	abs16
dsp:20[A0]	dsp:20[A1]	abs20	#IMM	dsp:20[A0]	dsp:20[A1]	abs20	SP/SP <sup>*2</sup>
R2R0	R3R1	A1A0		R2R0	R3R1	A1A0	

\*1 If (.B) is selected as the size specifier (.size), A0 or A1 cannot be chosen for *src* and *dest* simultaneously.

\*2 The operation is performed on the stack pointer indicated by the U flag. Only #IMM can be selected for *src*.

**[ Flag Change ]**

Flag	U	I	O	B	S	Z	D	C
Change	—	—	○	—	○	○	—	○

Conditions

- O** : The flag is set when a signed operation results in a value exceeding +32767 (.W) or -32768 (.W) or +127 (.B) or -128 (.B); otherwise cleared.
- S** : The flag is set when the operation results in MSB = 1; otherwise cleared.
- Z** : The flag is set when the operation results in 0; otherwise cleared.
- C** : The flag is set when an unsigned operation results in a value exceeding +65535 (.W) or +255 (.B); otherwise cleared.

**[ Description Example ]**

- ADD.B A0,R0L ; 8 low-order bits of A0 and R0L are added.
- ADD.B R0L,A0 ; R0L is zero-expanded and added to A0.
- ADD.B Ram:8[SB],R0L
- ADD.W #2,[A0]

**[ Related Instructions ]** ADC, ADCF, SBB, SUB

**[src/dest Classified by Format]****G format**

src				dest			
R0L/R0	R0H/R1	R1L/R2	R1H/R3	R0L/R0	R0H/R1	R1L/R2	R1H/R3
A0/A0 <sup>*1</sup>	A1/A1 <sup>*1</sup>	[A0]	[A1]	A0/A0 <sup>*1</sup>	A1/A1 <sup>*1</sup>	[A0]	[A1]
dsp:8[A0]	dsp:8[A1]	dsp:8[SB]	dsp:8[FB]	dsp:8[A0]	dsp:8[A1]	dsp:8[SB]	dsp:8[FB]
dsp:16[A0]	dsp:16[A1]	dsp:16[SB]	abs16	dsp:16[A0]	dsp:16[A1]	dsp:16[SB]	abs16
dsp:20[A0]	dsp:20[A1]	abs20	#IMM	dsp:20[A0]	dsp:20[A1]	abs20	SP/SP <sup>*2</sup>
R2R0	R3R1	A1A0		R2R0	R3R1	A1A0	

\*1 If (.B) is selected as the size specifier (.size), A0 or A1 cannot be chosen for *src* and *dest* simultaneously.

\*2 The operation is performed on the stack pointer indicated by the U flag. Only #IMM can be selected for *src*.

**Q format**

src				dest			
R0L/R0	R0H/R1	R1L/R2	R1H/R3	R0L/R0	R0H/R1	R1L/R2	R1H/R3
A0/A0	A1/A1	[A0]	[A1]	A0/A0	A1/A1	[A0]	[A1]
dsp:8[A0]	dsp:8[A1]	dsp:8[SB]	dsp:8[FB]	dsp:8[A0]	dsp:8[A1]	dsp:8[SB]	dsp:8[FB]
dsp:16[A0]	dsp:16[A1]	dsp:16[SB]	abs16	dsp:16[A0]	dsp:16[A1]	dsp:16[SB]	abs16
dsp:20[A0]	dsp:20[A1]	abs20	#IMM <sup>*3</sup>	dsp:20[A0]	dsp:20[A1]	abs20	SP/SP <sup>*2</sup>
R2R0	R3R1	A1A0		R2R0	R3R1	A1A0	

\*2 The operation is performed on the stack pointer indicated by the U flag. Only #IMM can be selected for *src*.

\*3 The acceptable range of values is  $-8 \leq \#IMM \leq +7$ .

**S format<sup>\*4</sup>**

src				dest			
R0L	R0H	dsp:8[SB]	dsp:8[FB]	R0L	R0H	dsp:8[SB]	dsp:8[FB]
abs16	#IMM			abs16	A0	A1	
R0L <sup>*5</sup>	R0H <sup>*5</sup>	dsp:8[SB]	dsp:8[FB]	R0L <sup>*5</sup>	R0H <sup>*5</sup>	dsp:8[SB]	dsp:8[FB]
abs16	#IMM			abs16	A0	A1	

\*4 Only (.B) can be selected as the size specifier (.size).

\*5 The same register cannot be used for *src* and *dest* simultaneously.

# ADJNZ

*Add and conditional jump*  
**Addition then Jump on Not Zero**

# ADJNZ

**[ Syntax ]**

ADJNZ.size src,dest,label

B, W

**[ Instruction Code/Number of Cycles ]**

Page: 146

**[ Operation ]**

dest ← dest + src  
 if dest ≠ 0 then jump label

**[ Function ]**

- This instruction adds *dest* and *src* and stores the result in *dest*.
- If the addition results in any value other than 0, control jumps to **label**. If the addition results in 0, the next instruction is executed.
- The op-code of this instruction is the same as that of SBJNZ.

**[ Selectable src/dest/label ]**

src	dest			label
#IMM*1	R0L/R0	R0H/R1	R1L/R2	PC*2-126 ≤ label ≤ PC*2+129
	R1H/R3	A0/A0	A1/A1	
	[A0]	[A1]	dsp:8[A0]	
	dsp:8[A1]	dsp:8[SB]	dsp:8[FB]	
	dsp:16[A0]	dsp:16[A1]	dsp:16[SB]	
	abs16			

\*1 The acceptable range of values is  $-8 \leq \#IMM \leq +7$ .

\*2 PC indicates the start address of the instruction.

**[ Flag Change ]**

Flag	U	I	O	B	S	Z	D	C
Change	—	—	—	—	—	—	—	—

**[ Description Example ]**

ADJNZ.W #-1,R0,label

**[ Related Instructions ]** SBJNZ

# AND

Logically AND  
AND

# AND

[ Syntax ]

AND.size (:format) src,dest

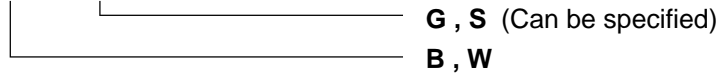

[ Instruction Code/Number of Cycles ]

Page: 147

[ Operation ]

dest ← src ∧ dest

[ Function ]

- This instruction logically ANDs *dest* and *src* and stores the result in *dest*.
- If *dest* is A0 or A1 and the selected size specifier (.size) is (.B), *src* is zero-expanded to perform calculation in 16 bits. If *src* is A0 or A1, operation is performed on the eight low-order bits of A0 or A1.

[ Selectable src/dest ]

(See next page for *src/dest* classified by format.)

src				dest			
R0L/R0	R0H/R1	R1L/R2	R1H/R3	R0L/R0	R0H/R1	R1L/R2	R1H/R3
A0/A0*1	A1/A1*1	[A0]	[A1]	A0/A0*1	A1/A1*1	[A0]	[A1]
dsp:8[A0]	dsp:8[A1]	dsp:8[SB]	dsp:8[FB]	dsp:8[A0]	dsp:8[A1]	dsp:8[SB]	dsp:8[FB]
dsp:16[A0]	dsp:16[A1]	dsp:16[SB]	abs16	dsp:16[A0]	dsp:16[A1]	dsp:16[SB]	abs16
dsp:20[A0]	dsp:20[A1]	abs20	#IMM	dsp:20[A0]	dsp:20[A1]	abs20	SP/SP
R2R0	R3R1	A1A0		R2R0	R3R1	A1A0	

\*1 If (.B) is selected as the size specifier (.size), A0 or A1 cannot be chosen for *src* and *dest* simultaneously.

[ Flag Change ]

Flag	U	I	O	B	S	Z	D	C
Change	—	—	—	—	○	○	—	—

Conditions

- S : The flag is set when the operation results in MSB = 1; otherwise cleared.
- Z : The flag is set when the operation results in 0; otherwise cleared.

[ Description Example ]

- AND.B Ram:8[SB],R0L
- AND.B:G A0,R0L ; 8 low-order bits of A0 and R0L are ANDed.
- AND.B:G R0L,A0 ; R0L is zero-expanded and ANDed with A0.
- AND.B:S #3,R0L

[ Related Instructions ] OR, XOR, TST

**[src/dest Classified by Format]****G format**

src				dest			
R0L/R0	R0H/R1	R1L/R2	R1H/R3	R0L/R0	R0H/R1	R1L/R2	R1H/R3
A0/A0 <sup>*1</sup>	A1/A1 <sup>*1</sup>	[A0]	[A1]	A0/A0 <sup>*1</sup>	A1/A1 <sup>*1</sup>	[A0]	[A1]
dsp:8[A0]	dsp:8[A1]	dsp:8[SB]	dsp:8[FB]	dsp:8[A0]	dsp:8[A1]	dsp:8[SB]	dsp:8[FB]
dsp:16[A0]	dsp:16[A1]	dsp:16[SB]	abs16	dsp:16[A0]	dsp:16[A1]	dsp:16[SB]	abs16
dsp:20[A0]	dsp:20[A1]	abs20	#IMM	dsp:20[A0]	dsp:20[A1]	abs20	SP/SP
R2R0	R3R1	A1A0		R2R0	R3R1	A1A0	

\*1 If (.B) is selected as the size specifier (.size), A0 or A1 cannot be chosen for *src* and *dest* simultaneously.

**S format<sup>\*2</sup>**

src				dest			
R0L	R0H	dsp:8[SB]	dsp:8[FB]	R0L	R0H	dsp:8[SB]	dsp:8[FB]
abs16	#IMM			abs16	A0	A1	
R0L <sup>*3</sup>	R0H <sup>*3</sup>	dsp:8[SB]	dsp:8[FB]	R0L <sup>*3</sup>	R0H <sup>*3</sup>	dsp:8[SB]	dsp:8[FB]
abs16	#IMM			abs16	A0	A1	

\*2 Only (.B) can be selected as the size specifier (.size).

\*3 The same register cannot be used for *src* and *dest*.

# BAND

*Logically AND bits*  
**Bit AND carry flag**

# BAND

**[ Syntax ]**

**BAND src**

**[ Instruction Code/Number of Cycles ]**

Page: 150

**[ Operation ]**

$C \leftarrow src \wedge C$

**[ Function ]**

- This instruction logically ANDs the C flag and *src* and stores the result in the C flag.

**[ Selectable src ]**

src			
bit,R0	bit,R1	bit,R2	bit,R3
bit,A0	bit,A1	[A0]	[A1]
base:8[A0]	base:8[A1]	bit,base:8[SB]	bit,base:8[FB]
base:16[A0]	base:16[A1]	bit,base:16[SB]	bit,base:16
€	bit,base:11[SB]		

**[ Flag Change ]**

Flag	U	I	O	B	S	Z	D	C
Change	—	—	—	—	—	—	—	○

Conditions

- C : The flag is set when the operation results in 1; otherwise cleared.

**[ Description Example ]**

BAND flag  
 BAND 4,Ram  
 BAND 16,Ram:16[SB]  
 BAND [A0]

**[ Related Instructions ]** BOR, BXOR, BNAND, BNOR, BNXOR

# BCLR

*Clear bit*  
Bit CLear

# BCLR

[ Syntax ]

BCLR (:format) dest

[ Instruction Code/Number of Cycles ]

Page: 150

\_\_\_\_\_ G , S (Can be specified)

[ Operation ]

dest ← 0

[ Function ]

- This instruction stores 0 in *dest*.

[ Selectable dest ]

dest			
bit,R0	bit,R1	bit,R2	bit,R3
bit,A0	bit,A1	[A0]	[A1]
base:8[A0]	base:8[A1]	bit,base:8[SB]	bit,base:8[FB]
base:16[A0]	base:16[A1]	bit,base:16[SB]	bit,base:16
	bit,base:11[SB]*1		

\*1 This *dest* can only be selected when in S format.

[ Flag Change ]

Flag	U	I	O	B	S	Z	D	C
Change	—	—	—	—	—	—	—	—

[ Description Example ]

BCLR flag  
 BCLR 4,Ram:8[SB]  
 BCLR 16,Ram:16[SB]  
 BCLR [A0]

[ Related Instructions ] BSET, BNOT, BNTST, BTST, BTSTC, BTSTS

# BM*Cnd*

## Conditional bit transfer Bit Move Condition

# BM*Cnd*

[ Syntax ]

**BM*Cnd***     **dest**

[ Instruction Code/Number of Cycles ]

Page: 152

[ Operation ]

**if true then**    dest ← 1  
**else**             dest ← 0

[ Function ]

- This instruction transfers the true or false value of the condition indicated by *Cnd* to *dest*. If the condition is true, 1 is transferred; if false, 0 is transferred.
- The supported types of *Cnd* are as follows.

<i>Cnd</i>	Condition	Expression	<i>Cnd</i>	Condition	Expression
GEU/C	C=1 Equal to or greater than C flag is 1.	$\cong$	LTU/NC	C=0 Less than C flag is 0.	$>$
EQ/Z	Z=1 Equal to Z flag is 1.	=	NE/NZ	Z=0 Not equal Z flag is 0.	$\neq$
GTU	$C \wedge \bar{Z}=1$ Greater than	$<$	LEU	$C \wedge \bar{Z}=0$ Equal to or less than	$\cong$
PZ	S=0 Positive or zero	$0 \cong$	N	S=1 Negative	$0 >$
GE	$S \vee O=0$ Equal to or greater than (signed value)	$\cong$	LE	$(S \vee O) \vee Z=1$ Equal to or less than (signed value)	$\cong$
GT	$(S \vee O) \vee Z=0$ Greater than (signed value)	$<$	LT	$S \vee O=1$ Less than (signed value)	$>$
O	O=1 O flag is 1.		NO	O=0 O flag is 0.	

[ Selectable dest ]

dest			
bit,R0	bit,R1	bit,R2	bit,R3
bit,A0	bit,A1	[A0]	[A1]
base:8[A0]	base:8[A1]	bit,base:8[SB]	bit,base:8[FB]
base:16[A0]	base:16[A1]	bit,base:16[SB]	bit,base:16
C		bit,base:14[SB]	

[ Flag Change ]

Flag	U	I	O	B	S	Z	D	C
Change	—	—	—	—	—	—	—	*1

\*1 The flag changes if the C flag was specified for *dest*.

[ Description Example ]

BMN     3,Ram:8[SB]  
BMZ     C

[ Related Instructions ]     *J*Cnd**

# BNAND

*Logically AND inverted bits*  
**Bit Not AND carry flag**

# BNAND

**[ Syntax ]**

**BNAND**     *src*

**[ Instruction Code/Number of Cycles ]**

Page: 153

**[ Operation ]**

$$C \leftarrow \overline{\text{src}} \wedge C$$
**[ Function ]**

- This instruction logically ANDs the C flag and the inverted value of *src* and stores the result in the C flag.

**[ Selectable src ]**

src			
bit,R0	bit,R1	bit,R2	bit,R3
bit,A0	bit,A1	[A0]	[A1]
base:8[A0]	base:8[A1]	bit,base:8[SB]	bit,base:8[FB]
base:16[A0]	base:16[A1]	bit,base:16[SB]	bit,base:16
€	bit,base:11[SB]		

**[ Flag Change ]**

Flag	U	I	O	B	S	Z	D	C
Change	—	—	—	—	—	—	—	○

Condition

C : The flag is set when the operation results in 1; otherwise cleared.

**[ Description Example ]**

BNAND     flag  
 BNAND     4,Ram  
 BNAND     16,Ram:16[SB]  
 BNAND     [A0]

**[ Related Instructions ]**     BAND, BOR, BXOR, BNOR, BNXOR

**BNOR**

*Logically OR inverted bits*  
**Bit Not OR carry flag**

**BNOR****[ Syntax ]**

BNOR src

**[ Instruction Code/Number of Cycles ]**

Page: 154

**[ Operation ]** $C \leftarrow \overline{\text{src}} \vee C$ **[ Function ]**

- This instruction logically ORs the C flag and the inverted value of *src* and stores the result in the C flag.

**[ Selectable src ]**

src			
bit,R0	bit,R1	bit,R2	bit,R3
bit,A0	bit,A1	[A0]	[A1]
base:8[A0]	base:8[A1]	bit,base:8[SB]	bit,base:8[FB]
base:16[A0]	base:16[A1]	bit,base:16[SB]	bit,base:16
$\oplus$	bit,base:11[SB]		

**[ Flag Change ]**

Flag	U	I	O	B	S	Z	D	C
Change	—	—	—	—	—	—	—	○

Condition

C : The flag is set when the operation results in 1; otherwise cleared.

**[ Description Example ]**

BNOR flag  
 BNOR 4,Ram  
 BNOR 16,Ram:16[SB]  
 BNOR [A0]

**[ Related Instructions ]** BAND, BOR, BXOR, BAND, BNOR

# BNOT

*Invert bit*  
Bit NOT

# BNOT

[ Syntax ]

BNOT(:format) dest G , S (Can be specified)

[ Instruction Code/Number of Cycles ]

Page: 154

[ Operation ]

dest ←  $\overline{\text{dest}}$

[ Function ]

- This instruction inverts *dest* and stores the result in *dest*.

[ Selectable dest ]

dest			
bit,R0	bit,R1	bit,R2	bit,R3
bit,A0	bit,A1	[A0]	[A1]
base:8[A0]	base:8[A1]	bit,base:8[SB]	bit,base:8[FB]
base:16[A0]	base:16[A1]	bit,base:16[SB]	bit,base:16
	bit,base:11[SB]*1		

\*1 This *dest* can only be selected when in S format.

[ Flag Change ]

Flag	U	I	O	B	S	Z	D	C
Change	—	—	—	—	—	—	—	—

[ Description Example ]

BNOT flag  
 BNOT 4,Ram:8[SB]  
 BNOT 16,Ram:16[SB]  
 BNOT [A0]

[ Related Instructions ] BCLR, BSET, BNTST, BTST, BTSTC, BTSTS

# BNTST

*Test inverted bit*  
**Bit Not TeST**

# BNTST

**[ Syntax ]**

**BNTST**      *src*

**[ Instruction Code/Number of Cycles ]**

Page: 155

**[ Operation ]**

$Z \leftarrow \overline{\text{src}}$   
 $C \leftarrow \overline{\text{src}}$

**[ Function ]**

- This instruction transfers the inverted value of *src* to the Z flag and the inverted value of *src* to the C flag.

**[ Selectable src ]**

src			
bit,R0	bit,R1	bit,R2	bit,R3
bit,A0	bit,A1	[A0]	[A1]
base:8[A0]	base:8[A1]	bit,base:8[SB]	bit,base:8[FB]
base:16[A0]	base:16[A1]	bit,base:16[SB]	bit,base:16
		bit,base:16[SB]	

**[ Flag Change ]**

Flag	<b>U</b>	<b>I</b>	<b>O</b>	<b>B</b>	<b>S</b>	<b>Z</b>	<b>D</b>	<b>C</b>
Change	—	—	—	—	—	○	—	○

Conditions

- Z** : The flag is set when *src* is 0; otherwise cleared.
- C** : The flag is set when *src* is 0; otherwise cleared.

**[ Description Example ]**

BNTST      flag  
 BNTST      4,Ram:8[SB]  
 BNTST      16,Ram:16[SB]  
 BNTST      [A0]

**[ Related Instructions ]**      BCLR, BSET, BNOT, BTST, BTSTC, BTSTS

# BNXOR

*Exclusive OR inverted bits*  
**Bit Not eXclusive OR carry flag**

# BNXOR

**[ Syntax ]**

**BNXOR**     *src*

**[ Instruction Code/Number of Cycles ]**

Page: 156

**[ Operation ]**

$$C \leftarrow \overline{\text{src}} \vee C$$
**[ Function ]**

- This instruction exclusive ORs the C flag and the inverted value of *src* and stores the result in the C flag.

**[ Selectable src ]**

src			
bit,R0	bit,R1	bit,R2	bit,R3
bit,A0	bit,A1	[A0]	[A1]
base:8[A0]	base:8[A1]	bit,base:8[SB]	bit,base:8[FB]
base:16[A0]	base:16[A1]	bit,base:16[SB]	bit,base:16
€	bit,base:11[SB]		

**[ Flag Change ]**

Flag	U	I	O	B	S	Z	D	C
Change	—	—	—	—	—	—	—	○

**Conditions**

- C** : The flag is set when the operation results in 1; otherwise cleared.

**[ Description Example ]**

BNXOR     flag  
 BNXOR     4,Ram  
 BNXOR     16,Ram:16[SB]  
 BNXOR     [A0]

**[ Related Instructions ]**     BAND, BOR, BXOR, BAND, BNOR

**BOR**

*Logically OR bits*  
**Bit OR carry flag**

**BOR****[ Syntax ]**

**BOR src**

**[ Instruction Code/Number of Cycles ]**

Page: 156

**[ Operation ]**

$C \leftarrow src \vee C$

**[ Function ]**

- This instruction logically ORs the C flag and *src* and stores the result in the C flag.

**[ Selectable src ]**

src			
bit,R0	bit,R1	bit,R2	bit,R3
bit,A0	bit,A1	[A0]	[A1]
base:8[A0]	base:8[A1]	bit,base:8[SB]	bit,base:8[FB]
base:16[A0]	base:16[A1]	bit,base:16[SB]	bit,base:16
€	bit,base:16[SB]		

**[ Flag Change ]**

Flag	U	I	O	B	S	Z	D	C
Change	—	—	—	—	—	—	—	○

Conditions

- C : The flag is set when the operation results in 1; otherwise cleared.

**[ Description Example ]**

BOR flag  
 BOR 4,Ram  
 BOR 16,Ram:16[SB]  
 BOR [A0]

**[ Related Instructions ]** BAND, BXOR, BNAND, BNOR, BNXOR

**BRK***Debug interrupt*  
**BReAK****BRK****[ Syntax ]****BRK****[ Instruction Code/Number of Cycles ]**

Page: 157

**[ Operation ]**

$SP \leftarrow SP - 2$   
 $M(SP) \leftarrow (PC + 1)_H, FLG$   
 $SP \leftarrow SP - 2$   
 $M(SP) \leftarrow (PC + 1)_ML$   
 $PC \leftarrow M(FFFE_{416})$

**[ Function ]**

- This instruction generates a BRK interrupt.
- The BRK interrupt is a nonmaskable interrupt.

**[ Flag Change ]<sup>\*1</sup>**

Flag	<b>U</b>	<b>I</b>	<b>O</b>	<b>B</b>	<b>S</b>	<b>Z</b>	<b>D</b>	<b>C</b>
Change	○	○	—	—	—	—	○	—

\*1 The flags are saved to the stack area before the BRK instruction is executed. After the interrupt, the flags change state as shown at left.

**Conditions**

- U : The flag is cleared.
- I : The flag is cleared.
- D : The flag is cleared.

**[ Description Example ]****BRK****[ Related Instructions ]** INT, INTO

**BSET**

*Set bit*  
Bit SET

**BSET****[ Syntax ]**

BSET (:format) dest

**[ Instruction Code/Number of Cycles ]**

Page: 157

G, S (Can be specified)

**[ Operation ]**

dest ← 1

**[ Function ]**

- This instruction stores 1 in *dest*.

**[ Selectable dest ]**

dest			
bit,R0	bit,R1	bit,R2	bit,R3
bit,A0	bit,A1	[A0]	[A1]
base:8[A0]	base:8[A1]	bit,base:8[SB]	bit,base:8[FB]
base:16[A0]	base:16[A1]	bit,base:16[SB]	bit,base:16
⊕	bit,base:11[SB] <sup>*1</sup>		

\*1 This *dest* can only be selected when in S format.

**[ Flag Change ]**

Flag	U	I	O	B	S	Z	D	C
Change	—	—	—	—	—	—	—	—

**[ Description Example ]**

BSET flag  
 BSET 4,Ram:8[SB]  
 BSET 16,Ram:16[SB]  
 BSET [A0]

**[ Related Instructions ]** BCLR, BNOT, BNTST, BTST, BTSTC, BTSTS

**BTST***Test bit*  
**Bit TeST****BTST****[ Syntax ]****BTST** (:format) **src****[ Instruction Code/Number of Cycles ]**

Page: 158

**G , S** (Can be specified)**[ Operation ]** $Z \leftarrow \overline{\text{src}}$  $C \leftarrow \text{src}$ **[ Function ]**

- This instruction transfers the inverted value of *src* to the Z flag and the non-inverted value of *src* to the C flag.

**[ Selectable src ]**

src			
bit,R0	bit,R1	bit,R2	bit,R3
bit,A0	bit,A1	[A0]	[A1]
base:8[A0]	base:8[A1]	bit,base:8[SB]	bit,base:8[FB]
base:16[A0]	base:16[A1]	bit,base:16[SB]	bit,base:16
Ⓜ	bit,base:11[SB] <sup>*1</sup>		

\*1 This *src* can only be selected when in S format.**[ Flag Change ]**

Flag	<b>U</b>	<b>I</b>	<b>O</b>	<b>B</b>	<b>S</b>	<b>Z</b>	<b>D</b>	<b>C</b>
Change	—	—	—	—	—	○	—	○

**Conditions**

- Z** : The flag is set when *src* is 0; otherwise cleared.  
**C** : The flag is set when *src* is 1; otherwise cleared.

**[ Description Example ]**

BTST flag  
 BTST 4,Ram:8[SB]  
 BTST 16,Ram:16[SB]  
 BTST [A0]

**[ Related Instructions ]** BCLR, BSET, BNOT, BNTST, BTSTC, BTSTS

# BTSTC

*Test bit and clear*  
Bit TeST and Clear

# BTSTC

**[ Syntax ]**

BTSTC      *dest*

**[ Instruction Code/Number of Cycles ]**

Page: 159

**[ Operation ]**

Z      ←  $\overline{\text{dest}}$   
C      ← *dest*  
*dest* ← 0

**[ Function ]**

- This instruction transfers the inverted value of *dest* to the Z flag and the non-inverted value of *dest* to the C flag. Then it stores 0 in *dest*.

**[ Selectable *dest* ]**

<b><i>dest</i></b>			
bit,R0	bit,R1	bit,R2	bit,R3
bit,A0	bit,A1	[A0]	[A1]
base:8[A0]	base:8[A1]	bit,base:8[SB]	bit,base:8[FB]
base:16[A0]	base:16[A1]	bit,base:16[SB]	bit,base:16
⊕	bit,base:11[SB]		

**[ Flag Change ]**

Flag	U	I	O	B	S	Z	D	C
Change	—	—	—	—	—	○	—	○

## Conditions

- Z : The flag is set when *dest* is 0; otherwise cleared.  
C : The flag is set when *dest* is 1; otherwise cleared.

**[ Description Example ]**

BTSTC      flag  
BTSTC      4,Ram  
BTSTC      16,Ram:16[SB]  
BTSTC      [A0]

**[ Related Instructions ]**      BCLR, BSET, BNOT, BNTST, BTST, BTSTS

# BTSTS

*Test bit and set*  
Bit TeST and Set

# BTSTS

**[ Syntax ]**

BTSTS dest

**[ Instruction Code/Number of Cycles ]**

Page: 160

**[ Operation ]**

Z ←  $\overline{\text{dest}}$   
C ← dest  
dest ← 1

**[ Function ]**

- This instruction transfers the inverted value of *dest* to the Z flag and the non-inverted value of *dest* to the C flag. Then it stores 1 in *dest*.

**[ Selectable dest ]**

dest			
bit,R0	bit,R1	bit,R2	bit,R3
bit,A0	bit,A1	[A0]	[A1]
base:8[A0]	base:8[A1]	bit,base:8[SB]	bit,base:8[FB]
base:16[A0]	base:16[A1]	bit,base:16[SB]	bit,base:16
⊕	bit,base:11[SB]		

**[ Flag Change ]**

Flag	U	I	O	B	S	Z	D	C
Change	—	—	—	—	—	○	—	○

## Conditions

- Z : The flag is set when *dest* is 0; otherwise cleared.  
C : The flag is set when *dest* is 1; otherwise cleared.

**[ Description Example ]**

BTSTS flag  
BTSTS 4,Ram  
BTSTS 16,Ram:16[SB]  
BTSTS [A0]

**[ Related Instructions ]** BCLR, BSET, BNOT, BNTST, BTST, BTSTC

**BXOR**

*Exclusive OR bits*  
**Bit eXclusive OR carry flag**

**BXOR****[ Syntax ]**

**BXOR src**

**[ Instruction Code/Number of Cycles ]**

Page: 160

**[ Operation ]**

$C \leftarrow src \vee C$

**[ Function ]**

- This instruction exclusive ORs the C flag and *src* and stores the result in the C flag.

**[ Selectable src ]**

src			
bit,R0	bit,R1	bit,R2	bit,R3
bit,A0	bit,A1	[A0]	[A1]
base:8[A0]	base:8[A1]	bit,base:8[SB]	bit,base:8[FB]
base:16[A0]	base:16[A1]	bit,base:16[SB]	bit,base:16
$\oplus$	bit,base:11[SB]		

**[ Flag Change ]**

Flag	U	I	O	B	S	Z	D	C
Change	—	—	—	—	—	—	—	○

Conditions

- C : The flag is set when the operation results in 1; otherwise cleared.

**[ Description Example ]**

BXOR flag  
 BXOR 4,Ram  
 BXOR 16,Ram:16[SB]  
 BXOR [A0]

**[ Related Instructions ]** BAND, BOR, BNAND, BNOR, BNXOR

# CMP

*Compare*  
**CoMPare**

# CMP

**[ Syntax ]****CMP.size (:format) src,dest**

\_\_\_\_\_ **G , Q , S** (Can be specified)  
 \_\_\_\_\_ **B , W**

**[ Instruction Code/Number of Cycles ]**

Page: 161

**[ Operation ]**

dest – src

**[ Function ]**

- Flag bits in the flag register change depending on the result of subtraction of *src* from *dest*.
- If *dest* is A0 or A1 and the selected size specifier (.size) is (.B), *src* is zero-expanded to perform operation in 16 bits. If *src* is A0 or A1, operation is performed on the 8 low-order bits of A0 or A1.

**[ Selectable src/dest ]**(See next page for *src/dest* classified by format.)

src				dest			
R0L/R0	R0H/R1	R1L/R2	R1H/R3	R0L/R0	R0H/R1	R1L/R2	R1H/R3
A0/A0 <sup>*1</sup>	A1/A1 <sup>*1</sup>	[A0]	[A1]	A0/A0 <sup>*1</sup>	A1/A1 <sup>*1</sup>	[A0]	[A1]
dsp:8[A0]	dsp:8[A1]	dsp:8[SB]	dsp:8[FB]	dsp:8[A0]	dsp:8[A1]	dsp:8[SB]	dsp:8[FB]
dsp:16[A0]	dsp:16[A1]	dsp:16[SB]	abs16	dsp:16[A0]	dsp:16[A1]	dsp:16[SB]	abs16
dsp:20[A0]	dsp:20[A1]	abs20	#IMM	dsp:20[A0]	dsp:20[A1]	abs20	SP/SP
R2R0	R3R1	A1A0		R2R0	R3R1	A1A0	

\*1 If (.B) is selected as the size specifier (.size), A0 or A1 cannot be chosen for *src* and *dest* simultaneously.

**[ Flag Change ]**

Flag	U	I	O	B	S	Z	D	C
Change	–	–	○	–	○	○	–	○

**Conditions**

- O** : The flag is set when a signed operation results in a value exceeding +32767 (.W) or –32768 (.W), or +127 (.B) or –128 (.B); otherwise cleared.
- S** : The flag is set when the operation results in MSB = 1; otherwise cleared.
- Z** : The flag is set when the operation results in 0; otherwise cleared.
- C** : The flag is set when an unsigned operation results in any value equal to or greater than 0; otherwise cleared.

**[ Description Example ]**

CMP.B:S #10,R0L

CMP.W:G R0,A0

CMP.W #–3,R0

CMP.B #5,Ram:8[FB]

CMP.B A0,R0L

; 8 low-order bits of A0 and R0L are compared.

**[src/dest Classified by Format]****G format**

src				dest			
R0L/R0	R0H/R1	R1L/R2	R1H/R3	R0L/R0	R0H/R1	R1L/R2	R1H/R3
A0/A0 <sup>*1</sup>	A1/A1 <sup>*1</sup>	[A0]	[A1]	A0/A0 <sup>*1</sup>	A1/A1 <sup>*1</sup>	[A0]	[A1]
dsp:8[A0]	dsp:8[A1]	dsp:8[SB]	dsp:8[FB]	dsp:8[A0]	dsp:8[A1]	dsp:8[SB]	dsp:8[FB]
dsp:16[A0]	dsp:16[A1]	dsp:16[SB]	abs16	dsp:16[A0]	dsp:16[A1]	dsp:16[SB]	abs16
dsp:20[A0]	dsp:20[A1]	abs20	#IMM	dsp:20[A0]	dsp:20[A1]	abs20	SP/SP
R2R0	R3R1	A1A0		R2R0	R3R1	A1A0	

\*1 If (.B) is selected as the size specifier (.size), A0 or A1 cannot be chosen for *src* and *dest* simultaneously.

**Q format**

src				dest			
R0L/R0	R0H/R1	R1L/R2	R1H/R3	R0L/R0	R0H/R1	R1L/R2	R1H/R3
A0/A0	A1/A1	[A0]	[A1]	A0/A0	A1/A1	[A0]	[A1]
dsp:8[A0]	dsp:8[A1]	dsp:8[SB]	dsp:8[FB]	dsp:8[A0]	dsp:8[A1]	dsp:8[SB]	dsp:8[FB]
dsp:16[A0]	dsp:16[A1]	dsp:16[SB]	abs16	dsp:16[A0]	dsp:16[A1]	dsp:16[SB]	abs16
dsp:20[A0]	dsp:20[A1]	abs20	#IMM <sup>*2</sup>	dsp:20[A0]	dsp:20[A1]	abs20	SP/SP
R2R0	R3R1	A1A0		R2R0	R3R1	A1A0	

\*2 The acceptable range of values is  $-8 \leq \#IMM \leq +7$ .

**S format<sup>\*3</sup>**

src				dest			
R0L	R0H	dsp:8[SB]	dsp:8[FB]	R0L	R0H	dsp:8[SB]	dsp:8[FB]
abs16	#IMM			abs16	A0	A1	
R0L <sup>*4</sup>	R0H <sup>*4</sup>	dsp:8[SB]	dsp:8[FB]	R0L <sup>*4</sup>	R0H <sup>*4</sup>	dsp:8[SB]	dsp:8[FB]
abs16	#IMM			abs16	A0	A1	

\*3 Only (.B) can be selected as the size specifier (.size).

\*4 The same register cannot be used for *src* and *dest*.

# DADC

## Decimal add with carry Decimal ADDition with Carry

# DADC

**[ Syntax ]**

DADC.size src,dest  
└──────────────────────────────────┘ B, W

**[ Instruction Code/Number of Cycles ]**

Page: 165

**[ Operation ]**

$$\text{dest} \leftarrow \text{src} + \text{dest} + \text{C}$$
**[ Function ]**

- This instruction adds *dest*, *src*, and the C flag as decimal data and stores the result in *dest*.

**[ Selectable src/dest ]**

src				dest			
R0L/R0	R0H/R1	R1L/R2	R1H/R3	R0L/R0	R0H/R1	R1L/R2	R1H/R3
A0/A0	A1/A1	[A0]	[A1]	A0/A0	A1/A1	[A0]	[A1]
dsp:8[A0]	dsp:8[A1]	dsp:8[SB]	dsp:8[FB]	dsp:8[A0]	dsp:8[A1]	dsp:8[SB]	dsp:8[FB]
dsp:16[A0]	dsp:16[A1]	dsp:16[SB]	abs16	dsp:16[A0]	dsp:16[A1]	dsp:16[SB]	abs16
dsp:20[A0]	dsp:20[A1]	abs20	#IMM	dsp:20[A0]	dsp:20[A1]	abs20	
R2R0	R3R1	A1A0		R2R0	R3R1	A1A0	

**[ Flag Change ]**

Flag	U	I	O	B	S	Z	D	C
Change	—	—	—	—	○	○	—	○

**Conditions**

- S** : The flag is set when the operation results in MSB = 1; otherwise cleared.
- Z** : The flag is set when the operation results in 0; otherwise cleared.
- C** : The flag is set when the operation results in a value exceeding +9999 (.W) or +99 (.B); otherwise cleared.

**[ Description Example ]**

DADC.B #3,R0L  
 DADC.W R1,R0

**[ Related Instructions ]** DADD, DSUB, DSBB

**DADD**

*Decimal add without carry*  
**Decimal ADDition**

**DADD****[ Syntax ]**

**DADD.size** **src,dest**  
 \_\_\_\_\_ **B , W**

**[ Instruction Code/Number of Cycles ]**

Page: 167

**[ Operation ]**

**dest** ← **src** + **dest**

**[ Function ]**

- This instruction adds *dest* and *src* as decimal data and stores the result in *dest*.

**[ Selectable src/dest ]**

src				dest			
R0L/R0	R0H/R1	R1L/R2	R1H/R3	R0L/R0	R0H/R1	R1L/R2	R1H/R3
A0/A0	A1/A1	[A0]	[A1]	A0/A0	A1/A1	[A0]	[A1]
dsp:8[A0]	dsp:8[A1]	dsp:8[SB]	dsp:8[FB]	dsp:8[A0]	dsp:8[A1]	dsp:8[SB]	dsp:8[FB]
dsp:16[A0]	dsp:16[A1]	dsp:16[SB]	abs16	dsp:16[A0]	dsp:16[A1]	dsp:16[SB]	abs16
dsp:20[A0]	dsp:20[A1]	abs20	#IMM	dsp:20[A0]	dsp:20[A1]	abs20	
R2R0	R3R1	A1A0		R2R0	R3R1	A1A0	

**[ Flag Change ]**

Flag	<b>U</b>	<b>I</b>	<b>O</b>	<b>B</b>	<b>S</b>	<b>Z</b>	<b>D</b>	<b>C</b>
Change	—	—	—	—	○	○	—	○

**Conditions**

- S** : The flag is set when the operation results in MSB = 1; otherwise cleared.
- Z** : The flag is set when the operation results in 0; otherwise cleared.
- C** : The flag is set when the operation results in a value exceeding +9999 (.W) or +99 (.B); otherwise cleared.

**[ Description Example ]**

**DADD.B** #3,R0L  
**DADD.W** R1,R0

**[ Related Instructions ]** DADC, DSUB, DSBB

**DEC**

*Decrement*  
DECrement

**DEC****[ Syntax ]**

DEC.size    dest  
 └──────────────────────────┘ B , W

**[ Instruction Code/Number of Cycles ]**

Page: 169

**[ Operation ]**

$$\text{dest} \leftarrow \text{dest} - 1$$
**[ Function ]**

- This instruction decrements *dest* by 1 and stores the result in *dest*.

**[ Selectable dest ]**

dest			
R0L <sup>*1</sup>	R0H <sup>*1</sup>	dsp:8[SB] <sup>*1</sup>	dsp:8[FB] <sup>*1</sup>
abs16 <sup>*1</sup>	A0 <sup>*2</sup>	A1 <sup>*2</sup>	

\*1 Only (.B) can be specified as the size specifier (.size).

\*2 Only (.W) can be specified as the size specifier (.size).

**[ Flag Change ]**

Flag	U	I	O	B	S	Z	D	C
Change	—	—	—	—	○	○	—	—

## Conditions

S : The flag is set when the operation results in MSB = 1; otherwise cleared.

Z : The flag is set when the operation results in 0; otherwise cleared.

**[ Description Example ]**

DEC.W    A0  
 DEC.B    R0L

**[ Related Instructions ]**    INC







**DSBB**

*Decimal subtract with borrow*  
**Decimal SuBtract with Borrow**

**DSBB****[ Syntax ]**

DSBB.size src,dest

B, W

**[ Instruction Code/Number of Cycles ]**

Page: 173

**[ Operation ]**

dest ← dest - src -  $\overline{C}$

**[ Function ]**

- This instruction subtracts *src* and the inverted value of the C flag from *dest* as decimal data and stores the result in *dest*.

**[ Selectable src/dest ]**

src				dest			
R0L/R0	R0H/R1	R1L/R2	R1H/R3	R0L/R0	R0H/R1	R1L/R2	R1H/R3
A0/A0	A1/A1	[A0]	[A1]	A0/A0	A1/A1	[A0]	[A1]
dsp:8[A0]	dsp:8[A1]	dsp:8[SB]	dsp:8[FB]	dsp:8[A0]	dsp:8[A1]	dsp:8[SB]	dsp:8[FB]
dsp:16[A0]	dsp:16[A1]	dsp:16[SB]	abs16	dsp:16[A0]	dsp:16[A1]	dsp:16[SB]	abs16
dsp:20[A0]	dsp:20[A1]	abs20	#IMM	dsp:20[A0]	dsp:20[A1]	abs20	
R2R0	R3R1	A1A0		R2R0	R3R1	A1A0	

**[ Flag Change ]**

Flag	U	I	O	B	S	Z	D	C
Change	—	—	—	—	○	○	—	○

**Conditions**

- S** : The flag is set when the operation results in MSB = 1; otherwise cleared.
- Z** : The flag is set when the operation results in 0; otherwise cleared.
- C** : The flag is set when the operation results in any value equal to or greater than 0; otherwise cleared.

**[ Description Example ]**

DSBB.B #3,R0L

DSBB.W R1,R0

**[ Related Instructions ]** DADC, DADD, DSUB

# DSUB

*Decimal subtract without borrow*  
**Decimal SUBtract**

# DSUB

**[ Syntax ]**

DSUB.size src,dest  
 └──────────────────────────┘ B, W

**[ Instruction Code/Number of Cycles ]**

Page: 175

**[ Operation ]**

dest ← dest - src

**[ Function ]**

- This instruction subtracts *src* from *dest* as decimal data and stores the result in *dest*.

**[ Selectable src/dest ]**

src				dest			
R0L/R0	R0H/R1	R1L/R2	R1H/R3	R0L/R0	R0H/R1	R1L/R2	R1H/R3
A0/A0	A1/A1	[A0]	[A1]	A0/A0	A1/A1	[A0]	[A1]
dsp:8[A0]	dsp:8[A1]	dsp:8[SB]	dsp:8[FB]	dsp:8[A0]	dsp:8[A1]	dsp:8[SB]	dsp:8[FB]
dsp:16[A0]	dsp:16[A1]	dsp:16[SB]	abs16	dsp:16[A0]	dsp:16[A1]	dsp:16[SB]	abs16
dsp:20[A0]	dsp:20[A1]	abs20	#IMM	dsp:20[A0]	dsp:20[A1]	abs20	
R2R0	R3R1	A1A0		R2R0	R3R1	A1A0	

**[ Flag Change ]**

Flag	U	I	O	B	S	Z	D	C
Change	—	—	—	—	○	○	—	○

**Conditions**

- S** : The flag is set when the operation results in MSB = 1; otherwise cleared.
- Z** : The flag is set when the operation results in 0; otherwise cleared.
- C** : The flag is set when the operation results in any value equal to or greater than 0; otherwise cleared.

**[ Description Example ]**

DSUB.B #3,R0L  
 DSUB.W R1,R0

**[ Related Instructions ]** DADC, DADD, DSBB

# ENTER

*Build stack frame*  
**ENTER function**

# ENTER

**[ Syntax ]**

**ENTER**      *src*

**[ Instruction Code/Number of Cycles ]**

Page: 177

**[ Operation ]**

SP            ←    SP - 2  
 M(SP)       ←    FB  
 FB           ←    SP  
 SP           ←    SP - *src*

**[ Function ]**

- This instruction generates a stack frame. *src* represents the size of the stack frame.
- The diagrams below show the stack area status before and after the ENTER instruction is executed at the beginning of a called subroutine.

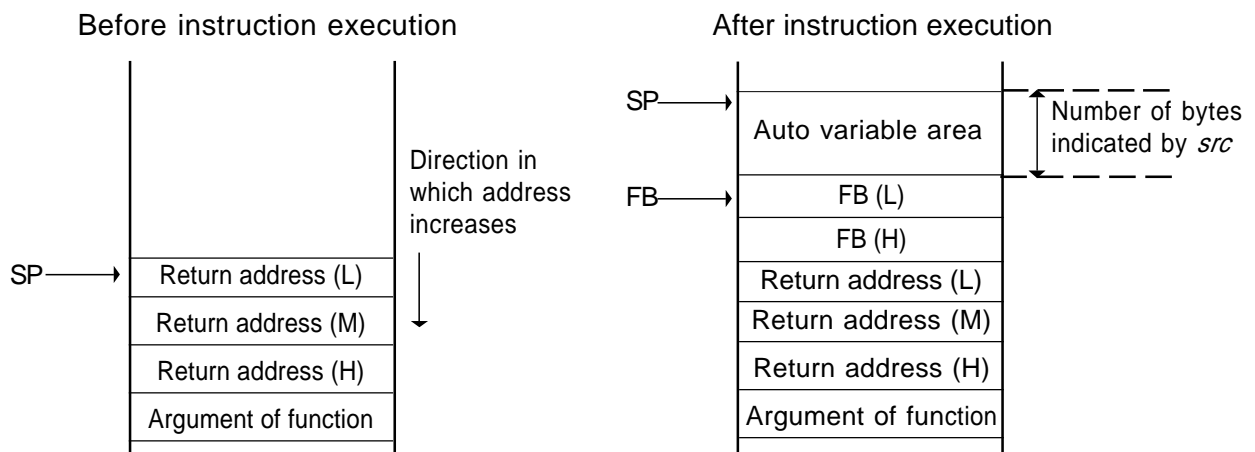

**[ Selectable *src* ]**

<b><i>src</i></b>
#IMM8

**[ Flag Change ]**

Flag	U	I	O	B	S	Z	D	C
Change	—	—	—	—	—	—	—	—

**[ Description Example ]**

**ENTER**      #3

**[ Related Instructions ]**      EXITD

# EXITD

## *Deallocate stack frame* EXIT and Deallocate stack frame

# EXITD

[ Syntax ]  
EXITD

[ Instruction Code/Number of Cycles ]  
Page: 178

[ Operation ]

SP ← FB  
 FB ← M(SP)  
 SP ← SP + 2  
 PCML ← M(SP)  
 SP ← SP + 2  
 PCH ← M(SP)  
 SP ← SP + 1

[ Function ]

- This instruction deallocates a stack frame and exits from the subroutine.
- Use this instruction in combination with the ENTER instruction.
- The diagrams below show the stack area status before and after the EXITD instruction is executed at the end of a subroutine in which an ENTER instruction was executed.

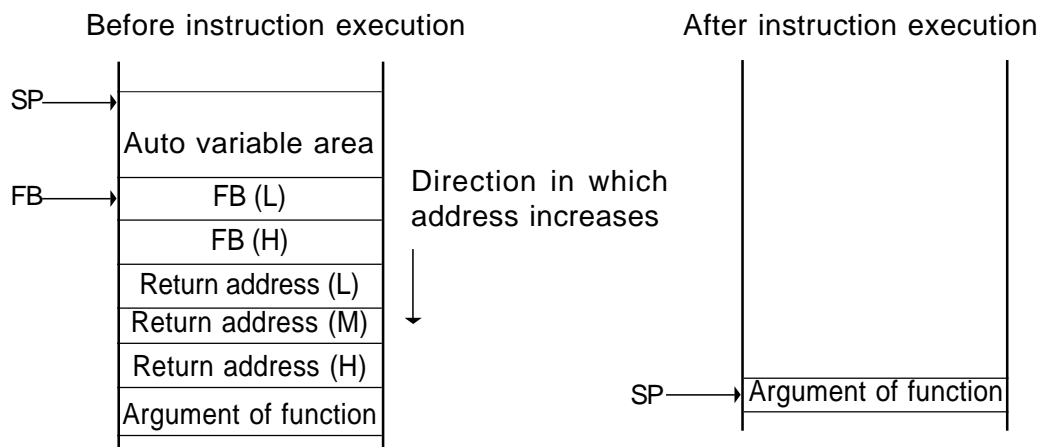

[ Flag Change ]

Flag	<b>U</b>	<b>I</b>	<b>O</b>	<b>B</b>	<b>S</b>	<b>Z</b>	<b>D</b>	<b>C</b>
Change	—	—	—	—	—	—	—	—

[ Description Example ]

EXITD

[ Related Instructions ]      ENTER

# EXTS

*Extend sign*  
**EXTend Sign**

# EXTS

**[ Syntax ]**

EXTS.size dest  
B, W

**[ Instruction Code/Number of Cycles ]**

Page: 178

**[ Operation ]**

dest ← EXT(dest)

**[ Function ]**

- This instruction sign extends *dest* and stores the result in *dest*.
- If (.B) is selected as the size specifier (.size), *dest* is sign extended to 16 bits.
- If (.W) is selected as the size specifier (.size), R0 is sign extended to 32 bits. In this case, R2 is used for the upper bytes.

**[ Selectable dest ]**

dest			
R0L/R0	R0H/R1	R1L/R2	R1H/R3
A0/A0	A1/A1	[A0]	[A1]
dsp:8[A0]	dsp:8[A1]	dsp:8[SB]	dsp:8[FB]
dsp:16[A0]	dsp:16[A1]	dsp:16[SB]	abs16
dsp:20[A0]	dsp:20[A1]	abs20	
R2R0	R3R1	A1A0	

**[ Flag Change ]**

Flag	U	I	O	B	S	Z	D	C
Change	—	—	—	—	○	○	—	—

Conditions

- S : If (.B) is selected as the size specifier (.size), the flag is set when the operation results in MSB = 1; otherwise cleared. The flag does not change if (.W) is selected as the size specifier (.size).
- Z : If (.B) is selected as the size specifier (.size), the flag is set when the operation results in 0; otherwise cleared. The flag does not change if (.W) is selected as the size specifier (.size).

**[ Description Example ]**

EXTS.B R0L  
EXTS.W R0

**FCLR****[ Syntax ]**FCLR *dest***[ Operation ]***dest* ← 0**[ Function ]**

- This instruction stores 0 in *dest*.

**[ Selectable dest ]**

<b>dest</b>							
C	D	Z	S	B	O	I	U

**[ Flag Change ]**

Flag	U	I	O	B	S	Z	D	C
Change	*1	*1	*1	*1	*1	*1	*1	*1

\*1 The selected flag is cleared to 0.

**[ Description Example ]**

FCLR I  
FCLR S

**[ Related Instructions ]** FSET

# FSET

*Set flag register bit*  
**Flag register SET**

# FSET

**[ Syntax ]**

FSET dest

**[ Instruction Code/Number of Cycles ]**

Page: 180

**[ Operation ]**

dest ← 1

**[ Function ]**

- This instruction stores 1 in *dest*.

**[ Selectable dest ]**

dest							
C	D	Z	S	B	O	I	U

**[ Flag Change ]**

Flag	U	I	O	B	S	Z	D	C
Change	*1	*1	*1	*1	*1	*1	*1	*1

\*1 The selected flag is set (= 1).

**[ Description Example ]**

FSET I  
 FSET S

**[ Related Instructions ]** FCLR

# INC

*Increment*  
**INC**rement

# INC

**[ Syntax ]**

INC.size                      dest  
 └──────────────────────────┘ B, W

**[ Instruction Code/Number of Cycles ]**

Page: 180

**[ Operation ]**

$$\text{dest} \leftarrow \text{dest} + 1$$
**[ Function ]**

- This instruction adds 1 to *dest* and stores the result in *dest*.

**[ Selectable dest ]**

dest			
ROL <sup>*1</sup>	R0H <sup>*1</sup>	dsp:8[SB] <sup>*1</sup>	dsp:8[FB] <sup>*1</sup>
abs16 <sup>*1</sup>	A0 <sup>*2</sup>	A1 <sup>*2</sup>	

\*1 Only (.B) can be selected as the size specifier (.size).

\*2 Only (.W) can be selected as the size specifier (.size).

**[ Flag Change ]**

Flag	U	I	O	B	S	Z	D	C
Change	—	—	—	—	○	○	—	—

## Conditions

S : The flag is set when the operation results in MSB = 1; otherwise cleared.

Z : The flag is set when the operation results in 0; otherwise cleared.

**[ Description Example ]**

INC.W      A0  
 INC.B      R0L

**[ Related Instructions ]**      DEC

**INT**

*Interrupt by INT instruction*  
**INTerrupt**

**INT****[ Syntax ]**

**INT**            **src**

**[ Instruction Code/Number of Cycles ]**

Page: 181

**[ Operation ]**

SP ← SP - 2  
M(SP) ← (PC + 2)<sub>H</sub>, FLG  
SP ← SP - 2  
M(SP) ← (PC + 2)<sub>ML</sub>  
PC ← M(IntBase + src × 4)

**[ Function ]**

- This instruction generates a software interrupt specified by *src*. *src* represents a software interrupt number.
- If *src* is 31 or smaller, the U flag is cleared to 0 and the interrupt stack pointer (ISP) is used.
- If *src* is 32 or larger, the stack pointer indicated by the U flag is used.
- The interrupts generated by the INT instruction are nonmaskable.

**[ Selectable src ]**

<b>src</b>
#IMM <sup>*1,2</sup>

\*1 #IMM denotes a software interrupt number.

\*2 The acceptable range of values is  $0 \leq \#IMM \leq 63$ .

**[ Flag Change ]**

Flag	<b>U</b>	<b>I</b>	<b>O</b>	<b>B</b>	<b>S</b>	<b>Z</b>	<b>D</b>	<b>C</b>
Change	○	○	—	—	—	—	○	—

\*3 The flags are saved to the stack area before the INT instruction is executed. After the interrupt, the flags change state as shown at left.

**Conditions**

- U** : The flag is cleared if the software interrupt number is 31 or smaller. The flag does not change if the software interrupt number is 32 or larger.
- I** : The flag is cleared.
- D** : The flag is cleared.

**[ Description Example ]**

INT            #0

**[ Related Instructions ]**    BRK, INTO

**INTO***Interrupt on overflow*  
**INTerrupt on Overflow****INTO**[ Syntax ]  
INTO[ Instruction Code/Number of Cycles ]  
Page: 182

## [ Operation ]

$SP \leftarrow SP - 2$   
 $M(SP) \leftarrow (PC + 1)_H, FLG$   
 $SP \leftarrow SP - 2$   
 $M(SP) \leftarrow (PC + 1)_{ML}$   
 $PC \leftarrow M(FFFE0_{16})$

## [ Function ]

- If the O flag is set to 1, this instruction generates an overflow interrupt. If the flag is cleared to 0, the next instruction is executed.
- The overflow interrupt is nonmaskable.

## [ Flag Change ]

Flag	U	I	O	B	S	Z	D	C
Change	○	○	—	—	—	—	○	—

\*1 The flags are saved to the stack area before the INTO instruction is executed. After the interrupt, the flags change state as shown at left.

## Conditions

- U : The flag is cleared.  
 I : The flag is cleared.  
 D : The flag is cleared.

## [ Description Example ]

INTO

[ Related Instructions ] BRK, INT

# JCnd

## Jump on condition Jump on Condition

# JCnd

**[ Syntax ]**

JCnd label

**[ Instruction Code/Number of Cycles ]**

Page: 182

**[ Operation ]**

if true then jump label

**[ Function ]**

- This instruction causes program flow to branch after checking the execution result of the preceding instruction against the following condition. If the condition indicated by *Cnd* is true, control jumps to **label**. If false, the next instruction is executed.
- The following conditions can be used for *Cnd*:

<i>Cnd</i>	Condition	Expression	<i>Cnd</i>	Condition	Expression
GEU/C	C=1 Equal to or greater than C flag is 1.	$\cong$	LTU/NC	C=0 Smaller than C flag is 0.	$>$
EQ/Z	Z=1 Equal to Z flag is 1.	$=$	NE/NZ	Z=0 Not equal Z flag is 0.	$\neq$
GTU	$C \wedge \bar{Z}=1$ Greater than	$<$	LEU	$C \wedge \bar{Z}=0$ Equal to or smaller than	$\cong$
PZ	S=0 Positive or zero	$0 \cong$	N	S=1 Negative	$0 >$
GE	$S \vee O=0$ Equal to or greater than (signed value)	$\cong$	LE	$(S \vee O) \vee Z=1$ Equal to or smaller than (signed value)	$\cong$
GT	$(S \vee O) \vee Z=0$ Greater than (signed value)	$<$	LT	$S \vee O=1$ Smaller than (signed value)	$>$
O	O=1 O flag is 1.		NO	O=0 O flag is 0.	

**[ Selectable label ]**

label	<i>Cnd</i>
$PC^{*1}-127 \cong \text{label} \cong PC^{*1}+128$	GEU/C, GTU, EQ/Z, N, LTU/NC, LEU, NE/NZ, PZ
$PC^{*1}-126 \cong \text{label} \cong PC^{*1}+129$	LE, O, GE, GT, NO, LT

\*1 PC indicates the start address of the instruction.

**[ Flag Change ]**

Flag	U	I	O	B	S	Z	D	C
Change	—	—	—	—	—	—	—	—

**[ Description Example ]**

```
JEQ    label
JNE    label
```

**[ Related Instructions ]**    BM*Cnd*

**JMP***Unconditional jump*  
**JuMP****JMP****[ Syntax ]**

JMP(.length) label

**[ Instruction Code/Number of Cycles ]**

Page: 184

\_\_\_\_\_ S , B , W , A (Can be specified)

**[ Operation ]**

PC ← label

**[ Function ]**

- This instruction causes control to jump to **label**.

**[ Selectable label ]**

.length	label
.S	$PC^{*1}+2 \leq \text{label} \leq PC^{*1}+9$
.B	$PC^{*1}-127 \leq \text{label} \leq PC^{*1}+128$
.W	$PC^{*1}-32767 \leq \text{label} \leq PC^{*1}+32768$
.A	abs20

\*1 PC indicates the start address of the instruction.

**[ Flag Change ]**

Flag	U	I	O	B	S	Z	D	C
Change	—	—	—	—	—	—	—	—

**[ Description Example ]**

JMP label

**[ Related Instructions ]** JMPI

# JMPI

*Jump indirect*  
**JuMP Indirect**

# JMPI

**[ Syntax ]**

**JMPI.length**          **src**  
 └──────────────────┬──────────  
                                 **W, A**

**[ Instruction Code/Number of Cycles ]**

Page: 185

**[ Operation ]**

When jump distance specifier (.length) is (.W)  
 PC ← PC ± src

When jump distance specifier (.length) is (.A)  
 PC ← src

**[ Function ]**

- This instruction causes control to jump to the address indicated by *src*. If *src* is a location in the memory, specify the address at which the low-order address is stored.
- If (.W) is selected as the jump distance specifier (.length), control jumps to the start address of the instruction plus the address indicated by *src* (added including the sign bits). If *src* is a location in the memory, the required memory capacity is 2 bytes.
- If *src* is a location in the memory and (.A) is selected as the jump distance specifier (.length), the required memory capacity is 3 bytes.

**[ Selectable src ]**

If (.W) is selected as the jump distance specifier (.length)

src			
R0L/R0	R0H/R1	R1L/R2	R1H/R3
A0/A0	A1/A1	[A0]	[A1]
dsp:8[A0]	dsp:8[A1]	dsp:8[SB]	dsp:8[FB]
dsp:16[A0]	dsp:16[A1]	dsp:16[SB]	abs16
dsp:20[A0]	dsp:20[A1]	abs20	
R2R0	R3R1	A1A0	

If (.A) is selected as the jump distance specifier (.length)

src			
R0L/R0	R0H/R1	R1L/R2	R1H/R3
A0/A0	A1/A1	[A0]	[A1]
dsp:8[A0]	dsp:8[A1]	dsp:8[SB]	dsp:8[FB]
dsp:16[A0]	dsp:16[A1]	dsp:16[SB]	abs16
dsp:20[A0]	dsp:20[A1]	abs20	
R2R0	R3R1	A1A0	

**[ Flag Change ]**

Flag	U	I	O	B	S	Z	D	C
Change	—	—	—	—	—	—	—	—

**[ Description Example ]**

JMPI.A      A1A0  
 JMPI.W      R0

**[ Related Instructions ]**      JMP

# JSR

*Subroutine call*  
**Jump SubRoutine**

# JSR

**[ Syntax ]**

**JSR(.length) label**

\_\_\_\_\_ **W, A** (Can be specified)

**[ Instruction Code/Number of Cycles ]**

Page: 187

**[ Operation ]**

SP ← SP - 1  
 M(SP) ← (PC + n)H  
 SP ← SP - 2  
 M(SP) ← (PC + n)ML  
 PC ← label

\*1 n denotes the number of instruction bytes.

**[ Function ]**

- This instruction causes control to jump to a subroutine indicated by **label**.

**[ Selectable label ]**

.length	label
.W	$PC^{*1}-32767 \leq \text{label} \leq PC^{*1}+32768$
.A	abs20

\*1 PC indicates the start address of the instruction.

**[ Flag Change ]**

Flag	U	I	O	B	S	Z	D	C
Change	—	—	—	—	—	—	—	—

**[ Description Example ]**

JSR.W func  
 JSR.A func

**[ Related Instructions ]** JSRI

# JSRI

## Indirect subroutine call Jump SubRoutine Indirect

# JSRI

[ Syntax ]

[ Instruction Code/Number of Cycles ]

JSRI.length src

Page: 188

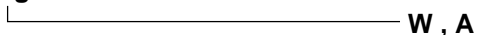

[ Operation ]

When jump distance specifier (.length) is (.W)

When jump distance specifier (.length) is (.A)

$$SP \leftarrow SP - 1$$

$$SP \leftarrow SP - 1$$

$$M(SP) \leftarrow (PC + n)H$$

$$M(SP) \leftarrow (PC + n)H$$

$$SP \leftarrow SP - 2$$

$$SP \leftarrow SP - 2$$

$$M(SP) \leftarrow (PC + n)ML$$

$$M(SP) \leftarrow (PC + n)H$$

$$PC \leftarrow PC \pm src$$

$$PC \leftarrow src$$

\*1 n denotes the number of instruction bytes.

[ Function ]

- This instruction causes control to jump to a subroutine at the address indicated by *src*. If *src* is a location in the memory, specify the address at which the low-order address is stored.
- If (.W) is selected as the jump distance specifier (.length), control jumps to the subroutine at the start address of the instruction plus the address indicated by *src* (added including the sign bits). If *src* is a location in the memory, the required memory capacity is 2 bytes.
- If *src* is a location in the memory and (.A) is selected as the jump distance specifier (.length), the required memory capacity is 3 bytes.

[ Selectable src ]

If (.W) is selected as the jump distance specifier (.length)

src			
R0L/R0	R0H/R1	R1L/R2	R1H/R3
A0/A0	A1/A1	[A0]	[A1]
dsp:8[A0]	dsp:8[A1]	dsp:8[SB]	dsp:8[FB]
dsp:16[A0]	dsp:16[A1]	dsp:16[SB]	abs16
dsp:20[A0]	dsp:20[A1]	abs20	
R2R0	R3R1	A1A0	

If (.A) is selected as the jump distance specifier (.length)

src			
R0L/R0	R0H/R1	R1L/R2	R1H/R3
A0/A0	A1/A1	[A0]	[A1]
dsp:8[A0]	dsp:8[A1]	dsp:8[SB]	dsp:8[FB]
dsp:16[A0]	dsp:16[A1]	dsp:16[SB]	abs16
dsp:20[A0]	dsp:20[A1]	abs20	
R2R0	R3R1	A1A0	

[ Flag Change ]

Flag	U	I	O	B	S	Z	D	C
Change	-	-	-	-	-	-	-	-

[ Description Example ]

JSRI.A A1A0

JSRI.W R0

[ Related Instructions ] JSR

**LDC**

*Transfer to control register*  
**Load Control register**

**LDC****[ Syntax ]**

LDC src,dest

**[ Instruction Code/Number of Cycles ]**

Page: 189

**[ Operation ]**

dest ← src

**[ Function ]**

- This instruction transfers *src* to the control register indicated by *dest*. If *src* is a location in the memory, the required memory capacity is 2 bytes.
- If the destination is INTBL or INTBH, make sure that bytes are transferred in succession.
- No interrupt requests are accepted immediately after this instruction.

**[ Selectable src/dest ]**

src				dest			
R0/R0	R0/R1	R1/R2	R2/R3	FB	SB	SP*1	ISP
A0/A0	A1/A1	[A0]	[A1]	FLG	INTBH	INTBL	
dsp:8[A0]	dsp:8[A1]	dsp:8[SB]	dsp:8[FB]				
dsp:16[A0]	dsp:16[A1]	dsp:16[SB]	abs16				
dsp:20[A0]	dsp:20[A1]	abs20	#IMM				
R2/R0	R3/R1	A1/A0					

\*1 Operation is performed on the stack pointer indicated by the U flag.

**[ Flag Change ]**

Flag	U	I	O	B	S	Z	D	C
Change	*2	*2	*2	*2	*2	*2	*2	*2

\*2 The flag changes only when *dest* is FLG.

**[ Description Example ]**

LDC R0,SB  
 LDC A0,FB

**[ Related Instructions ]** POPC, PUSHC, STC, LDINTB

# LDCTX

*Restore context*  
**LoaD ConTeXt**

# LDCTX

**[ Syntax ]**

LDCTX      abs16,abs20

**[ Instruction Code/Number of Cycles ]**

Page: 189

**[ Function ]**

- This instruction restores task context from the stack area.
- Set the RAM address that contains the task number in abs16 and the start address of table data in abs20.
- The required register information is specified from table data by the task number and the data in the stack area is transferred to each register according to the specified register information. Then the SP correction value is added to the stack pointer (SP). For this SP correction value, set the number of bytes to be transferred.
- Information on transferred registers is configured as shown below. Logical 1 indicates a register to be transferred and logical 0 indicates a register that is not transferred.

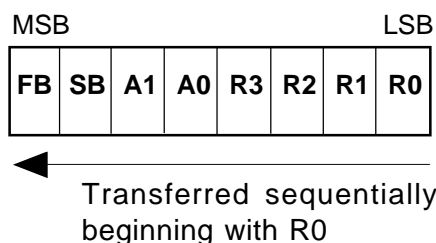

- The table data is configured as shown below. The address indicated by abs20 is the base address of the table. The data stored at an address twice the content of abs16 away from the base address indicates register information, and the next address contains the stack pointer correction value.

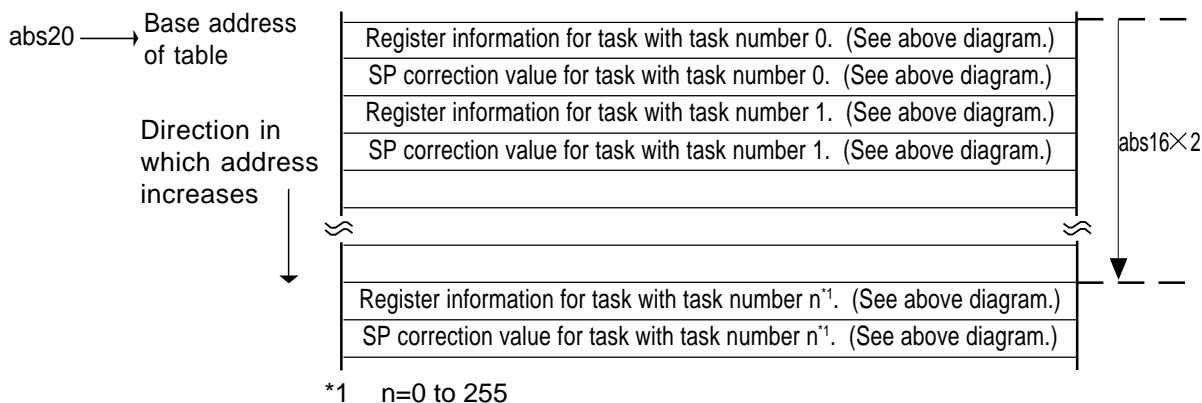

**[ Flag Change ]**

Flag	<b>U</b>	<b>I</b>	<b>O</b>	<b>B</b>	<b>S</b>	<b>Z</b>	<b>D</b>	<b>C</b>
Change	—	—	—	—	—	—	—	—

**[ Description Example ]**

LDCTX      Ram,Rom\_TBL

**[ Related Instructions ]**      STCTX

**LDE**

*Transfer from extended data area*  
**LoaD from EXtra far data area**

**LDE****[ Syntax ]**

LDE.size          src,dest  
 └──────────────────┬──────────┘  
                                   B, W

**[ Instruction Code/Number of Cycles ]**

Page: 191

**[ Operation ]**

dest ← src

**[ Function ]**

- This instruction transfers *src* from the extended area to *dest*.
- If *dest* is A0 or A1 and the selected size specifier (.size) is (.B), *src* is zero-expanded to transfer data in 16 bits.

**[ Selectable src/dest ]**

src				dest			
R0L/R0	R0H/R1	R1L/R2	R1H/R3	R0L/R0	R0H/R1	R1L/R2	R1H/R3
A0/A0	A1/A1	[A0]	[A1]	A0/A0	A1/A1	[A0]	[A1]
dsp:8[A0]	dsp:8[A1]	dsp:8[SB]	dsp:8[FB]	dsp:8[A0]	dsp:8[A1]	dsp:8[SB]	dsp:8[FB]
dsp:16[A0]	dsp:16[A1]	dsp:16[SB]	abs16	dsp:16[A0]	dsp:16[A1]	dsp:16[SB]	abs16
dsp:20[A0]	dsp:20[A1]	abs20	#HMM	dsp:20[A0]	dsp:20[A1]	abs20	
R2R0	R3R1	A1A0	[A1A0]	R2R0	R3R1	A1A0	

**[ Flag Change ]**

Flag	U	I	O	B	S	Z	D	C
Change	—	—	—	—	○	○	—	—

## Conditions

- S : The flag is set when the transfer results in MSB of *dest* = 1; otherwise cleared.  
 Z : The flag is set when the transfer results in *dest* = 0; otherwise cleared.

**[ Description Example ]**

LDE.W      [A1A0],R0  
 LDE.B      Rom\_TBL,A0

**[ Related Instructions ]**      STE, MOV, XCHG

# LDINTB

*Transfer to INTB register*  
**LoaD INTB register**

# LDINTB

**[ Syntax ]**

LDINTB src

**[ Instruction Code/Number of Cycles ]**

Page: 192

**[ Operation ]**

INTBHL ← src

**[ Function ]**

- This instruction transfers *src* to INTB.
- The LDINTB instruction is a macro-instruction consisting of the following:

LDC #IMM, INTBH

LDC #IMM, INTBL

**[ Selectable src ]**

<b>src</b>
#IMM20

**[ Flag Change ]**

Flag	U	I	O	B	S	Z	D	C
Change	—	—	—	—	—	—	—	—

**[ Description Example ]**

LDINTB #0F0000H

**[ Related Instructions ]** LDC, STC, PUSHC, POPC

**LDIPL**

*Set interrupt enable level*  
**LoaD Interrupt Permission Level**

**LDIPL****[ Syntax ]**LDIPL *src***[ Instruction Code/Number of Cycles ]**

Page: 193

**[ Operation ]**IPL ← *src***[ Function ]**

- This instruction transfers *src* to IPL.

**[ Selectable *src* ]**

<b><i>src</i></b>
#IMM <sup>*1</sup>

\*1 The acceptable range of values is  $0 \leq \#IMM \leq 7$

**[ Flag Change ]**

Flag	<b>U</b>	<b>I</b>	<b>O</b>	<b>B</b>	<b>S</b>	<b>Z</b>	<b>D</b>	<b>C</b>
Change	—	—	—	—	—	—	—	—

**[ Description Example ]**

LDIPL #2

# MOV

*Transfer*  
**MOVe**

# MOV

**[ Syntax ]****MOV.size (:format) src,dest****[ Instruction Code/Number of Cycles ]**

Page: 193

**G , Q , Z , S** (Can be specified)  
**B , W**

**[ Operation ]**

dest ← src

**[ Function ]**

- This instruction transfers *src* to *dest*.
- If *dest* is A0 or A1 and the selected size specifier (.size) is (.B), *src* is zero-expanded to transfer data in 16 bits. If *src* is A0 or A1, the 8 low-order bits of A0 or A1 are transferred.

**[ Selectable src/dest ]**(See next page for *src/dest* classified by format.)

src				dest			
R0L/R0	R0H/R1	R1L/R2	R1H/R3	R0L/R0	R0H/R1	R1L/R2	R1H/R3
A0/A0*1	A1/A1*1	[A0]	[A1]	A0/A0*1	A1/A1*1	[A0]	[A1]
dsp:8[A0]	dsp:8[A1]	dsp:8[SB]	dsp:8[FB]	dsp:8[A0]	dsp:8[A1]	dsp:8[SB]	dsp:8[FB]
dsp:16[A0]	dsp:16[A1]	dsp:16[SB]	abs16	dsp:16[A0]	dsp:16[A1]	dsp:16[SB]	abs16
dsp:20[A0]	dsp:20[A1]	abs20	#IMM*2	dsp:20[A0]	dsp:20[A1]	abs20	
R2R0	R3R1	A1A0	dsp:8[SP]*3	R2R0	R3R1	A1A0	dsp:8[SP]*2*3

\*1 If (.B) is selected as the size specifier (.size), A0 or A1 cannot be chosen for *src* and *dest* simultaneously.

\*2 If *src* is #IMM, dsp:8 [SP] cannot be chosen for *dest*.

\*3 The operation is performed on the stack pointer indicated by the U flag. dsp:8 [SP] cannot be chosen for *src* and *dest* simultaneously.

**[ Flag Change ]**

Flag	U	I	O	B	S	Z	D	C
Change	—	—	—	—	○	○	—	—

## Conditions

S : The flag is set when the transfer results in MSB of *dest* = 1; otherwise cleared.

Z : The flag is set when the transfer results in 0; otherwise cleared.

**[ Description Example ]**

MOV.B:S #0ABH,R0L

MOV.W #-1,R2

**[ Related Instructions ]** LDE, STE, XCHG

**[src/dest Classified by Format]****G format**

src				dest			
R0L/R0	R0H/R1	R1L/R2	R1H/R3	R0L/R0	R0H/R1	R1L/R2	R1H/R3
A0/A0 <sup>*1</sup>	A1/A1 <sup>*1</sup>	[A0]	[A1]	A0/A0 <sup>*1</sup>	A1/A1 <sup>*1</sup>	[A0]	[A1]
dsp:8[A0]	dsp:8[A1]	dsp:8[SB]	dsp:8[FB]	dsp:8[A0]	dsp:8[A1]	dsp:8[SB]	dsp:8[FB]
dsp:16[A0]	dsp:16[A1]	dsp:16[SB]	abs16	dsp:16[A0]	dsp:16[A1]	dsp:16[SB]	abs16
dsp:20[A0]	dsp:20[A1]	abs20	#IMM <sup>*2</sup>	dsp:20[A0]	dsp:20[A1]	abs20	SP/SP
R2R0	R3R1	A1A0	dsp:8[SP] <sup>*3</sup>	R2R0	R3R1	A1A0	dsp:8[SP] <sup>*2*3</sup>

\*1 If (.B) is selected as the size specifier (.size), A0 or A1 cannot be chosen for *src* and *dest* simultaneously.

\*2 If *src* is #IMM, dsp:8 [SP] cannot be chosen for *dest*.

\*3 The operation is performed on the stack pointer indicated by the U flag. dsp:8 [SP] cannot be chosen for *src* and *dest* simultaneously.

**Q format**

src				dest			
R0L/R0	R0H/R1	R1L/R2	R1H/R3	R0L/R0	R0H/R1	R1L/R2	R1H/R3
A0/A0	A1/A1	[A0]	[A1]	A0/A0	A1/A1	[A0]	[A1]
dsp:8[A0]	dsp:8[A1]	dsp:8[SB]	dsp:8[FB]	dsp:8[A0]	dsp:8[A1]	dsp:8[SB]	dsp:8[FB]
dsp:16[A0]	dsp:16[A1]	dsp:16[SB]	abs16	dsp:16[A0]	dsp:16[A1]	dsp:16[SB]	abs16
dsp:20[A0]	dsp:20[A1]	abs20	#IMM <sup>*4</sup>	dsp:20[A0]	dsp:20[A1]	abs20	SP/SP
R2R0	R3R1	A1A0		R2R0	R3R1	A1A0	

\*4 The acceptable range of values is  $-8 \leq \#IMM \leq +7$ .

**S format**

src				dest			
R0L <sup>*5*6*7</sup>	R0H <sup>*5*6*8</sup>	dsp:8[SB] <sup>*5</sup>	dsp:8[FB] <sup>*5</sup>	R0L <sup>*5*6</sup>	R0H <sup>*5*6</sup>		
abs16 <sup>*5</sup>	#IMM			abs16	A0 <sup>*5*8</sup>	A1 <sup>*5*7</sup>	
R0L <sup>*5*6</sup>	R0H <sup>*5*6</sup>	dsp:8[SB]	dsp:8[FB]	R0L <sup>*5*6</sup>	R0H <sup>*5*6</sup>	dsp:8[SB] <sup>*5</sup>	dsp:8[FB] <sup>*5</sup>
abs16	#IMM			abs16 <sup>*5</sup>	A0	A1	
R0L	R0H	dsp:8[SB]	dsp:8[FB]	R0L <sup>*5</sup>	R0H <sup>*5</sup>	dsp:8[SB] <sup>*5</sup>	dsp:8[FB] <sup>*5</sup>
abs16	#IMM <sup>*9</sup>			abs16 <sup>*5</sup>	A0 <sup>*9</sup>	A1 <sup>*9</sup>	

\*5 Only (.B) can be selected as the size specifier (.size).

\*6 The same register cannot be chosen for *src* and *dest*.

\*7 If *src* is R0L, only A1 can be selected for *dest* as the address register.

\*8 If *src* is R0H, only A0 can be selected for *dest* as the address register.

\*9 (.B) or (.W) can be selected as the size specifier (.size).

**Z format**

src				dest			
R0L	R0H	dsp:8[SB]	dsp:8[FB]	R0L	R0H	dsp:8[SB]	dsp:8[FB]
abs16	#0			abs16	A0	A1	

# MOVA

*Transfer effective address*  
**MOVE effective Address**

# MOVA

**[ Syntax ]**

**MOVA** *src,dest*

**[ Instruction Code/Number of Cycles ]**

Page: 200

**[ Operation ]**

*dest* ← EVA(*src*)

**[ Function ]**

- This instruction transfers the effective address of *src* to *dest*.

**[ Selectable src/dest ]**

src				dest			
R0L/R0	R0H/R1	R1L/R2	R1H/R3	R0L R0	R0H R1	R1L R2	R1H R3
A0/A0	A1/A1	[A0]	[A1]	A0 A0	A1/A1	[A0]	[A1]
dsp:8[A0]	dsp:8[A1]	dsp:8[SB]	dsp:8[FB]	dsp:8[A0]	dsp:8[A1]	dsp:8[SB]	dsp:8[FB]
dsp:16[A0]	dsp:16[A1]	dsp:16[SB]	abs16	dsp:16[A0]	dsp:16[A1]	dsp:16[SB]	abs16
dsp:20[A0]	dsp:20[A1]	abs20	#IMM	dsp:20[A0]	dsp:20[A1]	abs20	
R2R0	R3R1	A1A0		R2R0	R3R1	A1A0	

**[ Flag Change ]**

Flag	U	I	O	B	S	Z	D	C
Change	—	—	—	—	—	—	—	—

**[ Description Example ]**

**MOVA** *Ram:16[SB],A0*

**[ Related Instructions ]**    **PUSHA**

# MOVDir

Transfer 4-bit data  
MOVE nibble

# MOVDir

**[ Syntax ]**

MOVDir src,dest

**[ Instruction Code/Number of Cycles ]**

Page: 201

**[ Operation ]**

Dir	Operation
HH	H4:dest ← H4:src
HL	L4:dest ← H4:src
LH	H4:dest ← L4:src
LL	L4:dest ← L4:src

**[ Function ]**

- Be sure to choose R0L for either *src* or *dest*.

Dir	Function
HH	Transfers src's 4 high-order bits to dest's 4 high-order bits.
HL	Transfers src's 4 high-order bits to dest's 4 low-order bits.
LH	Transfers src's 4 low-order bits to dest's 4 high-order bits.
LL	Transfers src's 4 low-order bits to dest's 4 low-order bits.

**[ Selectable src/dest ]**

src				dest			
R0L/R0	R0H/R1	R1L/R2	R1H/R3	R0L/R0	R0H/R1	R1L/R2	R1H/R3
A0/A0	A1/A1	[A0]	[A1]	A0/A0	A1/A1	[A0]	[A1]
dsp:8[A0]	dsp:8[A1]	dsp:8[SB]	dsp:8[FB]	dsp:8[A0]	dsp:8[A1]	dsp:8[SB]	dsp:8[FB]
dsp:16[A0]	dsp:16[A1]	dsp:16[SB]	abs16	dsp:16[A0]	dsp:16[A1]	dsp:16[SB]	abs16
dsp:20[A0]	dsp:20[A1]	abs20	#IMM	dsp:20[A0]	dsp:20[A1]	abs20	
R2R0	R3R1	A1A0		R2R0	R3R1	A1A0	
R0L/R0	R0H/R1	R1L/R2	R1H/R3	R0L/R0	R0H/R1	R1L/R2	R1H/R3
A0/A0	A1/A1	[A0]	[A1]	A0/A0	A1/A1	[A0]	[A1]
dsp:8[A0]	dsp:8[A1]	dsp:8[SB]	dsp:8[FB]	dsp:8[A0]	dsp:8[A1]	dsp:8[SB]	dsp:8[FB]
dsp:16[A0]	dsp:16[A1]	dsp:16[SB]	abs16	dsp:16[A0]	dsp:16[A1]	dsp:16[SB]	abs16
dsp:20[A0]	dsp:20[A1]	abs20	#IMM	dsp:20[A0]	dsp:20[A1]	abs20	
R2R0	R3R1	A1A0		R2R0	R3R1	A1A0	

**[ Flag Change ]**

Flag	U	I	O	B	S	Z	D	C
Change	—	—	—	—	—	—	—	—

**[ Description Example ]**

MOVHH R0L,[A0]

MOVHL R0L,[A0]



# MULU

## *Unsigned multiply* MULTiple Unsigned

# MULU

### [ Syntax ]

**MULU.size src,dest**  
└───────────────────────────────────┘ **B , W**

### [ Instruction Code/Number of Cycles ]

Page: 205

### [ Operation ]

$dest \leftarrow dest \times src$

### [ Function ]

- This instruction multiplies *src* and *dest* without the sign bits and stores the result in *dest*.
- If (.B) is selected as the size specifier (.size), *src* and *dest* are treated as 8-bit data for the operation and the result is stored in 16 bits. If A0 or A1 is specified as either *src* or *dest*, the operation is performed using the 8 low-order bits of A0 or A1.
- If (.W) is selected as the size specifier (.size), *src* and *dest* are treated as 16-bit data for the operation and the result is stored in 32 bits. If R0, R1, or A0 are specified as *dest*, the result is stored in R2R0, R3R1, or A1A0 accordingly.

### [ Selectable src/dest ]

src				dest			
R0L/R0	R0H/R1	R1L/R2	R1H/R3	R0L/R0	R0H/R1	R1L/R2	R1H/R3
A0/A0*1	A1/A1*1	[A0]	[A1]	A0/A0*1	A1/A1	[A0]	[A1]
dsp:8[A0]	dsp:8[A1]	dsp:8[SB]	dsp:8[FB]	dsp:8[A0]	dsp:8[A1]	dsp:8[SB]	dsp:8[FB]
dsp:16[A0]	dsp:16[A1]	dsp:16[SB]	abs16	dsp:16[A0]	dsp:16[A1]	dsp:16[SB]	abs16
dsp:20[A0]	dsp:20[A1]	abs20	#IMM	dsp:20[A0]	dsp:20[A1]	abs20	
R2R0	R3R1	A1A0		R2R0	R3R1	A1A0	

\*1 If (.B) is selected as the size specifier (.size), A0 or A1 cannot be chosen for *src* and *dest* simultaneously.

### [ Flag Change ]

Flag	U	I	O	B	S	Z	D	C
Change	—	—	—	—	—	—	—	—

### [ Description Example ]

MULU.B A0,R0L ; 8 low-order bits of R0L and A0 are multiplied.  
 MULU.W #3,R0  
 MULU.B R0L,R1L  
 MULU.W A0,Ram

### [ Related Instructions ]

 DIV, DIVU, DIVX, MUL

**NEG**Complement of two  
**NEGate****NEG****[ Syntax ]**

**NEG.size**    **dest**

\_\_\_\_\_ **B, W**

**[ Instruction Code/Number of Cycles ]**

Page: 207

**[ Operation ]**

$$\text{dest} \leftarrow 0 - \text{dest}$$
**[ Function ]**

- This instruction takes the complement of two of *dest* and stores the result in *dest*.

**[ Selectable dest ]**

dest			
R0L/R0	R0H/R1	R1L/R2	R1H/R3
A0/A0	A1 A1	[A0]	[A1]
dsp:8[A0]	dsp:8[A1]	dsp:8[SB]	dsp:8[FB]
dsp:16[A0]	dsp:16[A1]	dsp:16[SB]	abs16
dsp:20[A0]	dsp:20[A1]	abs20	
R2R0	R3R1	A1A0	

**[ Flag Change ]**

Flag	<b>U</b>	<b>I</b>	<b>O</b>	<b>B</b>	<b>S</b>	<b>Z</b>	<b>D</b>	<b>C</b>
Change	—	—	○	—	○	○	—	○

## Conditions

- O** : The flag is set when *dest* before the operation is  $-128$  (.B) or  $-32768$  (.W); otherwise cleared.
- S** : The flag is set when the operation results in MSB = 1; otherwise cleared.
- Z** : The flag is set when the operation results in 0; otherwise cleared.
- C** : The flag is set when the operation results in 0; otherwise cleared.

**[ Description Example ]**

NEG.B    R0L  
NEG.W    A1

**[ Related Instructions ]**    NOT

# NOP

*No operation*  
**No OPeration**

# NOP

**[ Syntax ]**

NOP

**[ Instruction Code/Number of Cycles ]**

Page: 207

**[ Operation ]** $PC \leftarrow PC + 1$ **[ Function ]**

- This instruction adds 1 to PC.

**[ Flag Change ]**

Flag	U	I	O	B	S	Z	D	C
Change	—	—	—	—	—	—	—	—

**[ Description Example ]**

NOP

# NOT

*Invert all bits*  
**NOT**

# NOT

**[ Syntax ]****NOT.size (:format) dest****[ Instruction Code/Number of Cycles ]**

Page: 208

**G , S** (Can be specified)  
**B , W**

**[ Operation ]** $dest \leftarrow \overline{dest}$ **[ Function ]**

- This instruction inverts *dest* and stores the result in *dest*.

**[ Selectable dest ]**

dest			
R0L <sup>*1</sup> /R0	R0H <sup>*1</sup> /R1	R1L/R2	R1H/R3
A0/A0	A1 A1	[A0]	[A1]
dsp:8[A0]	dsp:8[A1]	dsp:8[SB] <sup>*1</sup>	dsp:8[FB] <sup>*1</sup>
dsp:16[A0]	dsp:16[A1]	dsp:16[SB]	abs16 <sup>*1</sup>
dsp:20[A0]	dsp:20[A1]	abs20	
R2R0	R3R1	A1A0	

- \*1 Can be selected in G and S formats.  
In other cases, *dest* can be selected in G format.

**[ Flag Change ]**

Flag	U	I	O	B	S	Z	D	C
Change	—	—	—	—	○	○	—	—

## Conditions

- S : The flag is set when the operation results in MSB = 1; otherwise cleared.  
Z : The flag is set when the operation results in 0; otherwise cleared.

**[ Description Example ]**

NOT.B     R0L  
NOT.W     A1

**[ Related Instructions ]**     NEG

# OR

Logically OR  
OR

# OR

[ Syntax ]

[ Instruction Code/Number of Cycles ]

OR.size (:format) src,dest

Page: 209

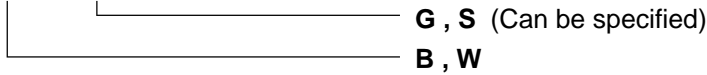

[ Operation ]

dest ← src ∨ dest

[ Function ]

- This instruction logically ORs *dest* and *src* and stores the result in *dest*.
- If *dest* is A0 or A1 and the selected size specifier (.size) is (.B), *src* is zero-expanded to perform operation in 16 bits. If *src* is A0 or A1, operation is performed using the 8 low-order bits of A0 or A1.

[ Selectable src/dest ]

(See next page for *src/dest* classified by format.)

src				dest			
R0L/R0	R0H/R1	R1L/R2	R1H/R3	R0L/R0	R0H/R1	R1L/R2	R1H/R3
A0/A0*1	A1/A1*1	[A0]	[A1]	A0/A0*1	A1/A1*1	[A0]	[A1]
dsp:8[A0]	dsp:8[A1]	dsp:8[SB]	dsp:8[FB]	dsp:8[A0]	dsp:8[A1]	dsp:8[SB]	dsp:8[FB]
dsp:16[A0]	dsp:16[A1]	dsp:16[SB]	abs16	dsp:16[A0]	dsp:16[A1]	dsp:16[SB]	abs16
dsp:20[A0]	dsp:20[A1]	abs20	#IMM	dsp:20[A0]	dsp:20[A1]	abs20	SP/SP
R2R0	R3R1	A1A0		R2R0	R3R1	A1A0	

\*1 If (.B) is selected as the size specifier (.size), A0 or A1 cannot be chosen for *src* and *dest* simultaneously.

[ Flag Change ]

Flag	U	I	O	B	S	Z	D	C
Change	—	—	—	—	○	○	—	—

Conditions

- S : The flag is set when the operation results in MSB = 1; otherwise cleared.
- Z : The flag is set when the operation results in 0; otherwise cleared.

[ Description Example ]

- OR.B Ram:8[SB],R0L
- OR.B:G A0,R0L ; 8 low-order bits of A0 and R0L are ORed.
- OR.B:G R0L,A0 ; R0L is zero-expanded and ORed with A0.
- OR.B:S #3,R0L

[ Related Instructions ] AND, XOR, TST

**[src/dest Classified by Format]****G format**

src				dest			
R0L/R0	R0H/R1	R1L/R2	R1H/R3	R0L/R0	R0H/R1	R1L/R2	R1H/R3
A0/A0 <sup>*1</sup>	A1/A1 <sup>*1</sup>	[A0]	[A1]	A0/A0 <sup>*1</sup>	A1/A1 <sup>*1</sup>	[A0]	[A1]
dsp:8[A0]	dsp:8[A1]	dsp:8[SB]	dsp:8[FB]	dsp:8[A0]	dsp:8[A1]	dsp:8[SB]	dsp:8[FB]
dsp:16[A0]	dsp:16[A1]	dsp:16[SB]	abs16	dsp:16[A0]	dsp:16[A1]	dsp:16[SB]	abs16
dsp:20[A0]	dsp:20[A1]	abs20	#IMM	dsp:20[A0]	dsp:20[A1]	abs20	SP/SP
R2R0	R3R1	A1A0		R2R0	R3R1	A1A0	

\*1 If (.B) is selected as the size specifier (.size), A0 or A1 cannot be chosen for *src* and *dest* simultaneously.

**S format<sup>\*2</sup>**

src				dest			
R0L	R0H	dsp:8[SB]	dsp:8[FB]	R0L	R0H	dsp:8[SB]	dsp:8[FB]
abs16	#IMM			abs16	A0	A1	
R0L <sup>*3</sup>	R0H <sup>*3</sup>	dsp:8[SB]	dsp:8[FB]	R0L <sup>*3</sup>	R0H <sup>*3</sup>	dsp:8[SB]	dsp:8[FB]
abs16	#IMM			abs16	A0	A1	

\*2 Only (.B) can be specified as the size specifier (.size).

\*3 The same register cannot be chosen for *src* and *dest*.

# POP

*Restore register/memory*

## POP

# POP

**[ Syntax ]**

POP.size (:format) dest

**G , S** (Can be specified)  

**B , W**

**[ Instruction Code/Number of Cycles ]**

Page: 211

**[ Operation ]**

If the size specifier (.size) is (.B)

dest ← M(SP)

SP ← SP + 1

If the size specifier (.size) is (.W)

dest ← M(SP)

SP ← SP + 2

**[ Function ]**

- This instruction restores *dest* from the stack area.

**[ Selectable dest ]**

dest			
R0L <sup>*1</sup> /R0	R0H <sup>*1</sup> /R1	R1L/R2	R1H/R3
A0/A0 <sup>*1</sup>	A1 A1 <sup>*1</sup>	[A0]	[A1]
dsp:8[A0]	dsp:8[A1]	dsp:8[SB]	dsp:8[FB]
dsp:16[A0]	dsp:16[A1]	dsp:16[SB]	abs16
dsp:20[A0]	dsp:20[A1]	abs20	
R2R0	R3R1	A1A0	

\*1 Can be selected in G and S formats.

In other cases, *dest* can be selected in G format.**[ Flag Change ]**

Flag	U	I	O	B	S	Z	D	C
Change	—	—	—	—	—	—	—	—

**[ Description Example ]**

POP.B     R0L

POP.W     A0

**[ Related Instructions ]**     PUSH, POPM, PUSHM

# POPC

*Restore control register*  
**POP Control register**

# POPC

**[ Syntax ]**

POPC dest

**[ Instruction Code/Number of Cycles ]**

Page: 213

**[ Operation ]**

dest ← M(SP)  
 SP\*1 ← SP + 2

\*1 When *dest* is SP or when the U flag = 0 and *dest* is ISP, 2 is not added to SP.

**[ Function ]**

- This instruction restores data from the stack area to the control register indicated by *dest*.
- When restoring an interrupt table register, always be sure to restore INTBH and INTBL in succession.
- No interrupt requests are accepted immediately after this instruction.

**[ Selectable dest ]**

dest						
FB	SB	SP <sup>2</sup>	ISP	FLG	INTBH	INTBL

\*2 Operation is performed on the stack pointer indicated by the U flag.

**[ Flag Change ]**

Flag	U	I	O	B	S	Z	D	C
Change	*3	*3	*3	*3	*3	*3	*3	*3

\*3 The flag changes only when *dest* is FLG.

**[ Description Example ]**

POPC SB

**[ Related Instructions ]** PUSHC, LDC, STC, LDINTB

# POPM

*Restore multiple registers*  
**POP Multiple**

# POPM

**[ Syntax ]**

**POPM**      *dest*

**[ Instruction Code/Number of Cycles ]**

Page: 213

**[ Operation ]**

*dest* ← M(SP)

SP ← SP + N\*1 × 2

\*1 Number of registers to be restored

**[ Function ]**

- This instruction restores the registers selected by *dest* collectively from the stack area.
- Registers are restored from the stack area in the following order:

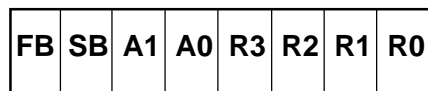

←  
Restored sequentially beginning with R0

**[ Selectable *dest* ]**

<b><i>dest</i><sup>*2</sup></b>							
R0	R1	R2	R3	A0	A1	SB	FB

\*2 More than one *dest* can be chosen.

**[ Flag Change ]**

Flag	<b>U</b>	<b>I</b>	<b>O</b>	<b>B</b>	<b>S</b>	<b>Z</b>	<b>D</b>	<b>C</b>
Change	—	—	—	—	—	—	—	—

**[ Description Example ]**

POPM      R0,R1,A0,SB,FB

**[ Related Instructions ]**      POP, PUSH, PUSHM

# PUSH

*Save register/memory/immediate data*

## PUSH

# PUSH

**[ Syntax ]**

PUSH.size (:format)

src

G, S (Can be specified)  
B, W**[ Instruction Code/Number of Cycles ]**

Page: 214

**[ Operation ]**

If the size specifier (.size) is (.B)

SP ← SP - 1

M(SP) ← src

If the size specifier (.size) is (.W)

SP ← SP - 2

M(SP) ← src

**[ Function ]**

- This instruction saves *src* to the stack area.

**[ Selectable src ]**

src			
R0L <sup>*1</sup> /R0	R0H <sup>*1</sup> /R1	R1L/R2	R1H/R3
A0/A0 <sup>*1</sup>	A1/A1 <sup>*1</sup>	[A0]	[A1]
dsp:8[A0]	dsp:8[A1]	dsp:8[SB]	dsp:8[FB]
dsp:16[A0]	dsp:16[A1]	dsp:16[SB]	abs16
dsp:20[A0]	dsp:20[A1]	abs20	#IMM
R2R0	R3R1	A1A0	

\*1 Can be selected in G and S formats.

In other cases, *dest* can be selected in G format.**[ Flag Change ]**

Flag	U	I	O	B	S	Z	D	C
Change	—	—	—	—	—	—	—	—

**[ Description Example ]**

```

PUSH.B #5
PUSH.W #100H
PUSH.B R0L
PUSH.W A0

```

**[ Related Instructions ]** POP, POPM, PUSHM

# PUSHA

*Save effective address*  
**PUSH effective Address**

# PUSHA

**[ Syntax ]**

**PUSHA**     **src**

**[ Instruction Code/Number of Cycles ]**

Page: 216

**[ Operation ]**

SP   ←   SP - 2  
M(SP) ←   EVA(src)

**[ Function ]**

- This instruction saves the effective address of *src* to the stack area.

**[ Selectable src ]**

src			
R0L/R0	R0H/R1	R1L/R2	R1H/R3
A0/A0	A1/A1	[A0]	[A1]
dsp:8[A0]	dsp:8[A1]	dsp:8[SB]	dsp:8[FB]
dsp:16[A0]	dsp:16[A1]	dsp:16[SB]	abs16
dsp:20[A0]	dsp:20[A1]	abs20	
R2R0	R3R1	A1A0	

**[ Flag Change ]**

Flag	U	I	O	B	S	Z	D	C
Change	—	—	—	—	—	—	—	—

**[ Description Example ]**

PUSHA     Ram:8[FB]  
PUSHA     Ram:16[SB]

**[ Related Instructions ]**     MOVA

# PUSHC

*Save control register*  
**PUSH Control register**

# PUSHC

**[ Syntax ]**

**PUSHC**     *src*

**[ Instruction Code/Number of Cycles ]**

Page: 216

**[ Operation ]**

$SP \leftarrow SP - 2$

$M(SP) \leftarrow src^{*1}$

\*1 When *src* is SP or when the U flag = 0 and *src* is ISP, SP is saved before 2 is subtracted.

**[ Function ]**

- This instruction saves the control register indicated by *src* to the stack area.

**[ Selectable src ]**

src							
FB	SB	SP <sup>2</sup>	ISP	FLG	INTBH	INTBL	

\*2 Operation is performed on the stack pointer indicated by the U flag.

**[ Flag Change ]**

Flag	U	I	O	B	S	Z	D	C
Change	—	—	—	—	—	—	—	—

**[ Description Example ]**

**PUSHC**     SB

**[ Related Instructions ]**     POPC, LDC, STC, LDINTB

# PUSHM

Save multiple registers  
**PUSH Multiple**

# PUSHM

**[ Syntax ]**

**PUSHM**     *src*

**[ Instruction Code/Number of Cycles ]**

Page: 217

**[ Operation ]**
$$SP \leftarrow SP - N^{*1} \times 2$$
$$M(SP) \leftarrow \textit{src}$$

\*1 Number of registers saved.

**[ Function ]**

- This instruction saves the registers selected by *src* collectively to the stack area.
- The registers are saved to the stack area in the following order:

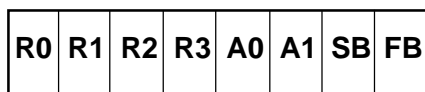

Saved sequentially beginning with FB

**[ Selectable src ]**

<b><i>src</i><sup>*2</sup></b>							
R0	R1	R2	R3	A0	A1	SB	FB

\*2 More than one *src* can be chosen.

**[ Flag Change ]**

Flag	<b>U</b>	<b>I</b>	<b>O</b>	<b>B</b>	<b>S</b>	<b>Z</b>	<b>D</b>	<b>C</b>
Change	-	-	-	-	-	-	-	-

**[ Description Example ]**

**PUSHM**     R0,R1,A0,SB,FB

**[ Related Instructions ]**     POP, PUSH, POPM

**REIT****[ Syntax ]**

REIT

*Return from interrupt*  
**REturn from InTerrupt****REIT****[ Instruction Code/Number of Cycles ]**

Page: 218

**[ Operation ]**

PCML ← M(SP)  
 SP ← SP + 2  
 PCH, FLG ← M(SP)  
 SP ← SP + 2

**[ Function ]**

- This instruction restores the PC and FLG values that were saved when an interrupt request was accepted and returns from the interrupt handler routine.

**[ Flag Change ]**

Flag	U	I	O	B	S	Z	D	C
Change	*1	*1	*1	*1	*1	*1	*1	*1

\*1 The flags are reset to the FLG state before the interrupt request was accepted.

**[ Description Example ]**

REIT

# RMPA

## Calculate sum-of-products Repeat MultiPle and Addition

# RMPA

**[ Syntax ]**

RMPA.size

B, W

**[ Instruction Code/Number of Cycles ]**

Page: 218

**[ Operation ]<sup>\*1</sup>****Repeat**

$$R2R0(R0)^{*2} \leftarrow R2R0(R0)^{*2} + M(A0) \times M(A1)$$

$$A0 \leftarrow A0 + 2(1)^{*2}$$

$$A1 \leftarrow A1 + 2(1)^{*2}$$

$$R3 \leftarrow R3 - 1$$

**Until** R3 = 0

\*1 If R3 is set to 0, this instruction is ignored.

\*2 Items in parentheses and followed by <sup>\*\*2</sup>( )<sup>\*2</sup> apply when (.B) is selected as the size specifier (.size).**[ Function ]**

- This instruction performs sum-of-product calculations, with the multiplicand address indicated by A0, the multiplier address indicated by A1, and the count of operation indicated by R3. Calculations are performed including the sign bits and the result is stored in R2R0 (R0)<sup>\*1</sup>.
- If an overflow occurs during operation, the O flag is set to terminate the operation. R2R0 (R0)<sup>\*1</sup> contains the result of the addition performed last. A0, A1, and R3 are undefined.
- The content of A0 or A1 when the instruction is completed indicates the next address after the last-read data.
- If an interrupt request is received during instruction execution, the interrupt is acknowledged after a sum-of-product addition is completed (i.e., after the content of R3 is decremented by 1).
- Make sure that R2R0 (R0)<sup>\*1</sup> is set to the initial value.

Items in parentheses and followed by <sup>\*\*1</sup>( )<sup>\*1</sup> apply when (.B) is selected as the size specifier (.size).**[ Flag Change ]**

Flag	U	I	O	B	S	Z	D	C
Change	—	—	○	—	—	—	—	—

**Conditions**

- : The flag is set when +2147483647 (.W) or -2147483648 (.W), or +32767 (.B) or -32768 (.B) is exceeded during operation; otherwise cleared.

**[ Description Example ]**

RMPA.B

# ROLC

*Rotate left with carry*  
**ROtate to Left with Carry**

# ROLC

[ Syntax ]

[ Instruction Code/Number of Cycles ]

ROLC.size dest  
 └──────────────────────────┘ B, W

Page: 218

[ Operation ]

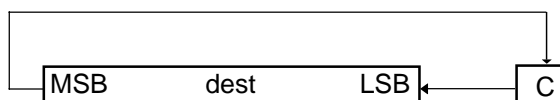

[ Function ]

- This instruction rotates *dest* one bit to the left including the C flag.

[ Selectable dest ]

dest			
ROL/R0	R0H/R1	R1L/R2	R1H/R3
A0/A0	A1 A1	[A0]	[A1]
dsp:8[A0]	dsp:8[A1]	dsp:8[SB]	dsp:8[FB]
dsp:16[A0]	dsp:16[A1]	dsp:16[SB]	abs16
dsp:20[A0]	dsp:20[A1]	abs20	
R2R0	R3R1	A1A0	

[ Flag Change ]

Flag	U	I	O	B	S	Z	D	C
Change	—	—	—	—	○	○	—	○

Conditions

- S : The flag is set when the operation results in MSB = 1; otherwise cleared.
- Z : The flag is set when the operation results in *dest* = 0; otherwise cleared.
- C : The flag is set when the shifted-out bit is 1; otherwise cleared.

[ Description Example ]

ROLC.B R0L  
 ROLC.W R0

[ Related Instructions ] RORC, ROT, SHA, SHL

# RORC

*Rotate right with carry*  
**ROtate to Right with Carry**

# RORC

**[ Syntax ]**

RORC.size dest  
 └──────────────────────────┘ B, W

**[ Instruction Code/Number of Cycles ]**

Page: 219

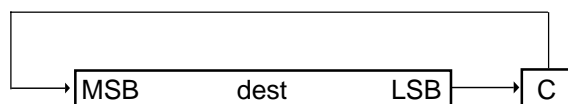
**[ Operation ]****[ Function ]**

- This instruction rotates *dest* one bit to the right including the C flag.

**[ Selectable dest ]**

dest			
R0L/R0	R0H/R1	R1L/R2	R1H/R3
A0/A0	A1/A1	[A0]	[A1]
dsp:8[A0]	dsp:8[A1]	dsp:8[SB]	dsp:8[FB]
dsp:16[A0]	dsp:16[A1]	dsp:16[SB]	abs16
dsp:20[A0]	dsp:20[A1]	abs20	
R2R0	R3R1	A1A0	

**[ Flag Change ]**

Flag	U	I	O	B	S	Z	D	C
Change	—	—	—	—	○	○	—	○

## Conditions

- S** : The flag is set when the operation results in MSB = 1; otherwise cleared.
- Z** : The flag is set when the operation results in *dest* = 0; otherwise cleared.
- C** : The flag is set when the shifted-out bit is 1; otherwise cleared.

**[ Description Example ]**

RORC.B ROL  
 RORC.W R0

**[ Related Instructions ]** ROLC, ROT, SHA, SHL

# ROT

## Rotate ROTate

# ROT

[ Syntax ]

[ Instruction Code/Number of Cycles ]

ROT.size src,dest  
B, W

Page: 220

[ Operation ]

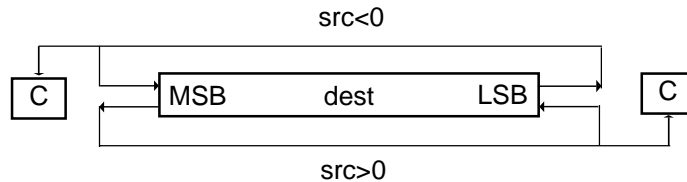

[ Function ]

- This instruction rotates *dest* left or right the number of bits indicated by *src*. Bits overflowing from LSB (MSB) are transferred to MSB (LSB) and the C flag.
- The direction of rotation is determined by the sign of *src*. If *src* is positive, bits are rotated left; if negative, bits are rotated right.
- If *src* is an immediate value, the number of bits rotated is  $-8$  to  $-1$  or  $+1$  to  $+8$ . Values less than  $-8$ , equal to  $0$ , or greater than  $+8$  are not valid.
- If *src* is a register and (.B) is selected as the size specifier (.size), the number of bits rotated is  $-8$  to  $+8$ . Although a value of  $0$  may be set, no bits are rotated and no flags are changed. If a value less than  $-8$  or greater than  $+8$  is set, the result of the rotation is undefined.
- If *src* is a register and (.W) is selected as the size specifier (.size), the number of bits rotated is  $-16$  to  $+16$ . Although a value of  $0$  may be set, no bits are rotated and no flags are changed. If a value less than  $-16$  or greater than  $+16$  is set, the result of the rotation is undefined.

[ Selectable src/dest ]

src				dest			
R0L/R0	R0H/R1	R1L/R2	R1H <sup>*1</sup> /R3	R0L/R0	R0H/R1 <sup>*1</sup>	R1L/R2	R1H/R3 <sup>*1</sup>
A0/A0	A1/A1	[A0]	[A1]	A0 A0	A1/A1	[A0]	[A1]
dsp:8[A0]	dsp:8[A1]	dsp:8[SB]	dsp:8[FB]	dsp:8[A0]	dsp:8[A1]	dsp:8[SB]	dsp:8[FB]
dsp:16[A0]	dsp:16[A1]	dsp:16[SB]	abs16	dsp:16[A0]	dsp:16[A1]	dsp:16[SB]	abs16
dsp:20[A0]	dsp:20[A1]	abs20	#IMM <sup>*2</sup>	dsp:20[A0]	dsp:20[A1]	abs20	
R2R0	R3R1	A1A0		R2R0	R3R1	A1A0	

\*1 If *src* is R1H, R1 or R1H cannot be chosen for *dest*.

\*2 The acceptable range of values is  $-8 \leq \#IMM \leq +8$ . However,  $0$  is invalid.

[ Flag Change ]

Flag	U	I	O	B	S	Z	D	C
Change	—	—	—	—	○	○	—	○

\*1 If the number of bits rotated is  $0$ , no flags are changed.

Conditions

- S : The flag is set when the operation results in MSB = 1; otherwise cleared.
- Z : The flag is set when the operation results in 0; otherwise cleared.
- C : The flag is set when the bit shifted out last is 1; otherwise cleared.

[ Description Example ]

ROT.B #1,R0L ; Rotated left  
 ROT.B #-1,R0L ; Rotated right  
 ROT.W R1H,R2

[ Related Instructions ] ROLC, RORC, SHA, SHL

**RTS**

*Return from subroutine*  
**ReTurn from Subroutine**

**RTS****[ Syntax ]**

RTS

**[ Instruction Code/Number of Cycles ]**

Page: 221

**[ Operation ]**

PCML ← M(SP)  
 SP ← SP + 2  
 PCH ← M(SP)  
 SP ← SP + 1

**[ Function ]**

- This instruction causes control to return from a subroutine.

**[ Flag Change ]**

Flag	U	I	O	B	S	Z	D	C
Change	—	—	—	—	—	—	—	—

**[ Description Example ]**

RTS



**SBJNZ**

*Subtract and conditional jump*  
**SuBtract then Jump on Not Zero**

**SBJNZ****[ Syntax ]**

**SBJNZ.size** *src,dest,label*  
\_\_\_\_\_ **B, W**

**[ Instruction Code/Number of Cycles ]**

Page: 224

**[ Operation ]**

$dest \leftarrow dest - src$   
 if  $dest = 0$  then jump label

**[ Function ]**

- This instruction subtracts *src* from *dest* and stores the result in *dest*.
- If the operation results in any value other than 0, control jumps to **label**. If the operation results in 0, the next instruction is executed.
- The op-code of this instruction is the same as that of ADJNZ.

**[ Selectable src/dest/label ]**

src	dest			label
#IMM* <sup>1</sup>	R0L/R0	R0H/R1	R1L/R2	$PC^*2-126 \leq label \leq PC^*2+129$
	R1H/R3	<del>A0</del> /A0	<del>A1</del> /A1	
	[A0]	[A1]	dsp:8[A0]	
	dsp:8[A1]	dsp:8[SB]	dsp:8[FB]	
	dsp:16[A0]	dsp:16[A1]	dsp:16[SB]	
	abs16			

\*1 The acceptable range of values is  $-7 \leq \#IMM \leq +8$ .

\*2 PC indicates the start address of the instruction.

**[ Flag Change ]**

Flag	U	I	O	B	S	Z	D	C
Change	—	—	—	—	—	—	—	—

**[ Description Example ]**

SBJNZ.W #1,R0,label

**[ Related Instructions ]** ADJNZ

# SHA

## Shift arithmetic SHift Arithmetic

# SHA

[ Syntax ]

SHA.size src,dest

[ Instruction Code/Number of Cycles ]

Page: 225

[ Operation ]

When *src* < 0

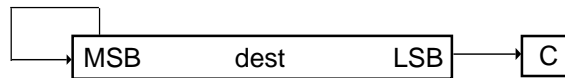

When *src* > 0

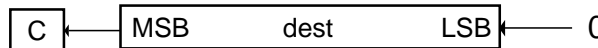

[ Function ]

- This instruction arithmetically shifts *dest* left or right the number of bits indicated by *src*. Bits overflowing from LSB (MSB) are transferred to the C flag.
- If *src* is an immediate value, the number of bits shifted is  $-8$  to  $-1$  or  $+1$  to  $+8$ . Values less than  $-8$ , equal to 0, or greater than  $+8$  are not valid.
- If *src* is a register and (.B) is selected as the size specifier (.size), the number of bits shifted is  $-8$  to  $+8$ . Although a value of 0 may be set, no bits are shifted and no flags are changed. If a value less than  $-8$  or greater than  $+8$  is set, the result of the shift is undefined.
- If *src* is a register and (.W) or (.L) is selected as the size specifier (.size), the number of bits shifted is  $-16$  to  $+16$ . Although a value of 0 may be set, no bits are shifted and no flags are changed. If a value less than  $-16$  or greater than  $+16$  is set, the result of shift is undefined.

[ Selectable src/dest ]

src				dest			
R0L/R0	R0H/R1	R1L/R2	R1H <sup>*1</sup> /R3	R0L/R0	R0H/R1 <sup>*1</sup>	R1L/R2	R1H/R3 <sup>*1</sup>
A0/A0	A1/A1	[A0]	[A1]	A0/A0	A1/A1	[A0]	[A1]
dsp:8[A0]	dsp:8[A1]	dsp:8[SB]	dsp:8[FB]	dsp:8[A0]	dsp:8[A1]	dsp:8[SB]	dsp:8[FB]
dsp:16[A0]	dsp:16[A1]	dsp:16[SB]	abs16	dsp:16[A0]	dsp:16[A1]	dsp:16[SB]	abs16
dsp:20[A0]	dsp:20[A1]	abs20	#IMM <sup>*2</sup>	dsp:20[A0]	dsp:20[A1]	abs20	
R2R0	R3R1	A1A0		R2R0 <sup>*3</sup>	R3R1 <sup>*3</sup>	A1A0	

\*1 If *src* is R1H, R1 or R1H cannot be chosen for *dest*.

\*2 The acceptable range of values is  $-8 \leq \text{\#IMM} \leq +8$ . However, 0 is invalid.

\*3 Only (.L) can be selected as the size specifier (.size). (.B) or (.W) can also be specified for *dest*.

[ Flag Change ]

Flag	U	I	O	B	S	Z	D	C
Change	—	—	○	—	○	○	—	○

\*1 If the number of bits shifted is 0, no flags are changed.

Conditions

- O : The flag is set when the operation results in MSB changing its state from 1 to 0 or from 0 to 1; otherwise cleared. However, the flag does not change if (.L) is selected as the size specifier (.size).
- S : The flag is set when the operation results in MSB = 1; otherwise cleared.
- Z : The flag is set when the operation results in 0; otherwise cleared. However, the flag value is undefined if (.L) is selected as the size specifier (.size).
- C : The flag is set when the bit shifted out last is 1; otherwise cleared. However, the flag is indeterminate if (.L) is selected as the size specifier (.size).

[ Description Example ]

SHA.B #3,R0L ; Arithmetically shifted left  
 SHA.B #-3,R0L ; Arithmetically shifted right  
 SHA.L R1H,R2R0

[ Related Instructions ] ROLC, RORC, ROT, SHL



# SMOVB

*Transfer string backward*  
String MOVE Backward

# SMOVB

**[ Syntax ]**

SMOVB.size

B, W

**[ Instruction Code/Number of Cycles ]**

Page: 230

**[ Operation ]\*1**

When size specifier (.size) is (.B)

**Repeat** $M(A1) \leftarrow M(2^{16} \times R1H + A0)$  $A0^{*2} \leftarrow A0 - 1$  $A1 \leftarrow A1 - 1$  $R3 \leftarrow R3 - 1$ **Until**

R3 = 0

When size specifier (.size) is (.W)

**Repeat** $M(A1) \leftarrow M(2^{16} \times R1H + A0)$  $A0^{*2} \leftarrow A0 - 2$  $A1 \leftarrow A1 - 2$  $R3 \leftarrow R3 - 1$ **Until**

R3 = 0

\*1 If R3 is set to 0, this instruction is ignored.

\*2 If A0 underflows, the content of R1H is decremented by 1.

**[ Function ]**

- This instruction transfers a string from a 20-bit source address to a 16-bit destination address by successively decrementing the address.
- Set the 4 high-order bits of the source address in R1H, the 16 low-order bits of the source address in A0, the destination address in A1, and the transfer count in R3.
- When the instruction is completed, A0 or A1 contains the next address after the last-read data.
- If an interrupt request is received during instruction execution, the interrupt is acknowledged after one data transfer is completed.

**[ Flag Change ]**

Flag	U	I	O	B	S	Z	D	C
Change	—	—	—	—	—	—	—	—

**[ Description Example ]**

SMOVB.B

**[ Related Instructions ]** SMOVF, SSTR

# SMOVF

*Transfer string forward*  
**String MOVE Forward**

# SMOVF

**[ Syntax ]**

SMOVF.size

B, W

**[ Instruction Code/Number of Cycles ]**

Page: 231

**[ Operation ]\*1**

When size specifier (.size) is (.B)

**Repeat** $M(A1) \leftarrow M(2^{16} \times R1H + A0)$  $A0^{*2} \leftarrow A0 + 1$  $A1 \leftarrow A1 + 1$  $R3 \leftarrow R3 - 1$ **Until**

R3 = 0

When size specifier (.size) is (.W)

**Repeat** $M(A1) \leftarrow M(2^{16} \times R1H + A0)$  $A0^{*2} \leftarrow A0 + 2$  $A1 \leftarrow A1 + 2$  $R3 \leftarrow R3 - 1$ **Until**

R3 = 0

\*1 If R3 is set to 0, this instruction is ignored.

\*2 If A0 overflows, the content of R1H is incremented by 1.

**[ Function ]**

- This instruction transfers a string from a 20-bit source address to a 16-bit destination address by successively incrementing the address.
- Set the 4 high-order bits of the source address in R1H, the 16 low-order bits of the source address in A0, the destination address in A1, and the transfer count in R3.
- When the instruction is completed, A0 or A1 contains the next address after the last-read data.
- If an interrupt request is received during instruction execution, the interrupt is acknowledged after one data transfer is completed.

**[ Flag Change ]**

Flag	U	I	O	B	S	Z	D	C
Change	—	—	—	—	—	—	—	—

**[ Description Example ]**

SMOVF.W

**[ Related Instructions ]** SMOVB, SSTR

**SSTR***Store string*  
**String SToRe****SSTR****[ Syntax ]****SSTR.size****B , W****[ Instruction Code/Number of Cycles ]**

Page: 231

**[ Operation ]\*1**

When size specifier (.size) is (.B)

**Repeat** $M(A1) \leftarrow R0L$  $A1 \leftarrow A1 + 1$  $R3 \leftarrow R3 - 1$ **Until** $R3 = 0$ 

When size specifier (.size) is (.W)

**Repeat** $M(A1) \leftarrow R0$  $A1 \leftarrow A1 + 2$  $R3 \leftarrow R3 - 1$ **Until** $R3 = 0$ 

\*1 If R3 is set to 0, this instruction is ignored.

**[ Function ]**

- This instruction stores a string with the data to be stored indicated by R0, the transfer address indicated by A1, and the transfer count indicated by R3.
- When the instruction is completed, A0 or A1 contains the next address after the last-written data.
- If an interrupt request is received during instruction execution, the interrupt is acknowledged after one data transfer is completed.

**[ Flag Change ]**

Flag	U	I	O	B	S	Z	D	C
Change	—	—	—	—	—	—	—	—

**[ Description Example ]**

SSTR.B

**[ Related Instructions ]** SMOVB, SMOVF

**STC***Transfer from control register*  
**STore from Control register****STC****[ Syntax ]**

STC src,dest

**[ Instruction Code/Number of Cycles ]**

Page: 232

**[ Operation ]**

dest ← src

**[ Function ]**

- This instruction transfers the content of the control register indicated by *src* to *dest*. If *dest* is a location in the memory, specify the address in which to store the low-order address.
- If *dest* is a location in the memory and *src* is PC, the required memory capacity is 3 bytes. If *src* is not PC, the required memory capacity is 2 bytes.

**[ Selectable src/dest ]**

src				dest			
FB	SB	SP <sup>*1</sup>	ISP	R0L R0	R0H R1	R1L R2	R1H R3
FLG	INTBH	INTBL		A0 A0	A1/A1	[A0]	[A1]
				dsp:8[A0]	dsp:8[A1]	dsp:8[SB]	dsp:8[FB]
				dsp:16[A0]	dsp:16[A1]	dsp:16[SB]	abs16
				dsp:20[A0]	dsp:20[A1]	abs20	
				R2R0	R3R1	A1A0	
PC				R0L/R0	R0H/R1	R1L/R2	R1H/R3
				A0/A0	A1/A1	[A0]	[A1]
				dsp:8[A0]	dsp:8[A1]	dsp:8[SB]	dsp:8[FB]
				dsp:16[A0]	dsp:16[A1]	dsp:16[SB]	abs16
				dsp:20[A0]	dsp:20[A1]	abs20	
				R2R0	R3R1	A1A0	

\*1 The operation is performed on the stack pointer indicated by the U flag.

**[ Flag Change ]**

Flag	U	I	O	B	S	Z	D	C
Change	—	—	—	—	—	—	—	—

**[ Description Example ]**

STC SB,R0

STC FB,A0

**[ Related Instructions ]** POPC, PUSHC, LDC, LDINTB

# STCTX

*Save context*  
**STore ConTeXt**

# STCTX

[ Syntax ]

STCTX      abs16,abs20

[ Instruction Code/Number of Cycles ]

Page: 233

[ Operation ]

[ Function ]

- This instruction saves task context to the stack area.
- Set the RAM address that contains the task number in abs16 and the start address of table data in abs20.
- The required register information is specified from table data by the task number and the data in the stack area is transferred to each register according to the specified register information. Then the SP correction value is subtracted from the stack pointer (SP). For this SP correction value, set the number of bytes to be transferred.
- Information on transferred registers is configured as shown below. Logical 1 indicates a register to be transferred and logical 0 indicates a register that is not to be transferred.

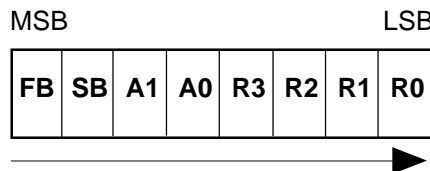

Transferred sequentially beginning with FB

- The table data is configured as shown below. The address indicated by abs20 is the base address of the table. The data stored at an address twice the content of abs16 away from the base address indicates register information, and the next address contains the stack pointer correction value.

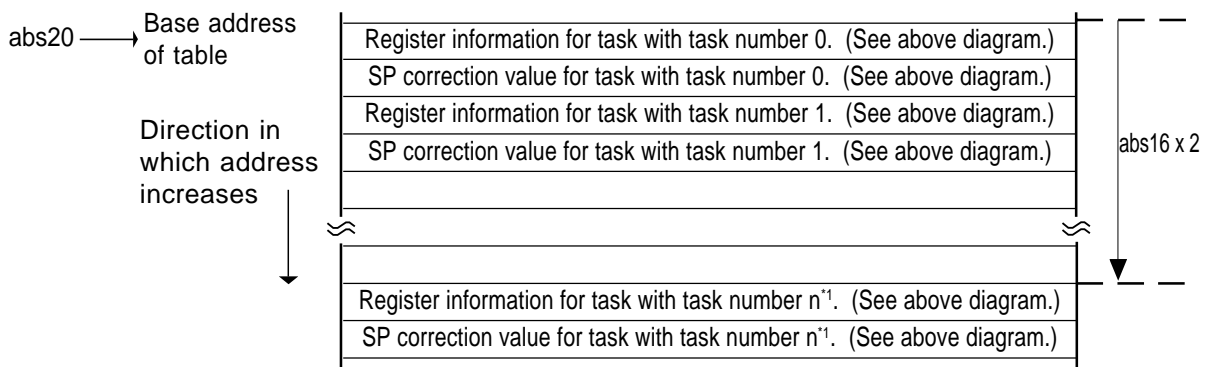

\*1 n=0 to 255

[ Flag Change ]

Flag	U	I	O	B	S	Z	D	C
Change	—	—	—	—	—	—	—	—

[ Description Example ]

STCTX      Ram,Rom\_TBL

[ Related Instructions ]      LDCTX

# STE

*Transfer to extended data area*  
**ST**ore to **EX**tra far data area

# STE

**[ Syntax ]**

STE.size                  src,dest  
 └──────────────────────────┘ B, W

**[ Instruction Code/Number of Cycles ]**

Page: 233

**[ Operation ]**

dest ← src

**[ Function ]**

- This instruction transfers *src* to *dest* in an extended area.
- If *src* is A0 or A1 and the selected size specifier (.size) is (.B), the operation is performed on the 8 low-order bits of A0 or A1. However, the flag changes depending on the A0 or A1 status (16 bits) before the operation is performed.

**[ Selectable src/dest ]**

src				dest			
R0L/R0	R0H/R1	R1L/R2	R1H/R3	R0L/R0	R0H/R1	R1L/R2	R1H/R3
A0/A0	A1/A1	[A0]	[A1]	A0/A0	A1/A1	[A0]	[A1]
dsp:8[A0]	dsp:8[A1]	dsp:8[SB]	dsp:8[FB]	dsp:8[A0]	dsp:8[A1]	dsp:8[SB]	dsp:8[FB]
dsp:16[A0]	dsp:16[A1]	dsp:16[SB]	abs16	dsp:16[A0]	dsp:16[A1]	dsp:16[SB]	abs16
dsp:20[A0]	dsp:20[A1]	abs20	#HMM	dsp:20[A0]	dsp:20[A1]	abs20	
R2R0	R3R1	A1A0		R2R0	R3R1	[A1A0]	

**[ Flag Change ]**

Flag	U	I	O	B	S	Z	D	C
Change	—	—	—	—	○	○	—	—

**Conditions**

- S : The flag is set when the operation results in MSB = 1; otherwise cleared.  
 Z : The flag is set when the operation results in 0; otherwise cleared.

**[ Description Example ]**

STE.B      R0L,[A1A0]  
 STE.W      R0,10000H[A0]

**[ Related Instructions ]**      MOV, LDE, XCHG

# STNZ

*Conditional transfer*  
**STore on Not Zero**

# STNZ

**[ Syntax ]**

STNZ      src,dest

**[ Instruction Code/Number of Cycles ]**

Page: 235

**[ Operation ]**

if Z = 0 then    dest ← src

**[ Function ]**

- This instruction transfers *src* to *dest* when the Z flag is 0.

**[ Selectable src/dest ]**

src	dest			
#IMM8	R0L	R0H	dsp:8[SB]	dsp:8[FB]
	abs16	A0	A1	

**[ Flag Change ]**

Flag	U	I	O	B	S	Z	D	C
Change	—	—	—	—	—	—	—	—

**[ Description Example ]**

STNZ      #5,Ram:8[SB]

**[ Related Instructions ]**    STZ, STZX

**STZ**

*Conditional transfer*  
**STore on Zero**

**STZ****[ Syntax ]**

**STZ** *src,dest*

**[ Instruction Code/Number of Cycles ]**

Page: 235

**[ Operation ]**

if Z = 1 then *dest* ← *src*

**[ Function ]**

- This instruction transfers *src* to *dest* when the Z flag is 1.

**[ Selectable src/dest ]**

<b>src</b>	<b>dest</b>			
#IMM8	R0L	R0H	dsp:8[SB]	dsp:8[FB]
	abs16	A0	A+	

**[ Flag Change ]**

Flag	<b>U</b>	<b>I</b>	<b>O</b>	<b>B</b>	<b>S</b>	<b>Z</b>	<b>D</b>	<b>C</b>
Change	—	—	—	—	—	—	—	—

**[ Description Example ]**

STZ #5,Ram:8[SB]

**[ Related Instructions ]** STNZ, STZX

**STZX***Conditional transfer*  
**STore on Zero eXtention****STZX****[ Syntax ]**

STZX src1,src2,dest

**[ Instruction Code/Number of Cycles ]**

Page: 236

**[ Operation ]**

If Z = 1 then

dest ← src1

else

dest ← src2

**[ Function ]**

- This instruction transfers *src1* to *dest* when the Z flag is 1. When the Z flag is 0, it transfers *src2* to *dest*.

**[ Selectable src/dest ]**

src	dest			
#IMM8	R0L	R0H	dsp:8[SB]	dsp:8[FB]
	abs16	A0	A+	

**[ Flag Change ]**

Flag	U	I	O	B	S	Z	D	C
Change	—	—	—	—	—	—	—	—

**[ Description Example ]**

STZX #1,#2,Ram:8[SB]

**[ Related Instructions ]** STZ, STNZ

# SUB

*Subtract without borrow*  
**SUBtract**

# SUB

**[ Syntax ]**

**[ Instruction Code/Number of Cycles ]**

**SUB.size (:format) src,dest**

Page: 236

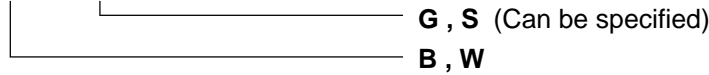

**[ Operation ]**

dest ← dest - src

**[ Function ]**

- This instruction subtracts *src* from *dest* and stores the result in *dest*.
- If *dest* is A0 or A1 and the selected size specifier (.size) is (.B), *src* is zero-expanded to perform operation in 16 bits. If *src* is A0 or A1, operation is performed on the 8 low-order bits of A0 or A1.

**[ Selectable src/dest ]**

(See next page for *src/dest* classified by format.)

src				dest			
R0L/R0	R0H/R1	R1L/R2	R1H/R3	R0L/R0	R0H/R1	R1L/R2	R1H/R3
A0/A0*1	A1/A1*1	[A0]	[A1]	A0/A0*1	A1/A1*1	[A0]	[A1]
dsp:8[A0]	dsp:8[A1]	dsp:8[SB]	dsp:8[FB]	dsp:8[A0]	dsp:8[A1]	dsp:8[SB]	dsp:8[FB]
dsp:16[A0]	dsp:16[A1]	dsp:16[SB]	abs16	dsp:16[A0]	dsp:16[A1]	dsp:16[SB]	abs16
dsp:20[A0]	dsp:20[A1]	abs20	#IMM	dsp:20[A0]	dsp:20[A1]	abs20	SP/SP
R2R0	R3R1	A1A0		R2R0	R3R1	A1A0	

\*1 If (.B) is selected as the size specifier (.size), A0 or A1 cannot be chosen for *src* and *dest* simultaneously.

**[ Flag Change ]**

Flag	U	I	O	B	S	Z	D	C
Change	—	—	○	—	○	○	—	○

Conditions

- O** : The flag is set when a signed operation results in a value in exceeding +32767 (.W) or -32768 (.W), or +127 (.B) or -128 (.B); otherwise cleared.
- S** : The flag is set when the operation results in MSB = 1; otherwise cleared.
- Z** : The flag is set when the operation results in 0; otherwise cleared.
- C** : The flag is set when an unsigned operation results in any value equal to or greater than 0; otherwise cleared.

**[ Description Example ]**

- SUB.B A0,R0L ; 8 low-order bits of A0 and R0L are the objects of the operation.
- SUB.B R0L,A0 ; Zero-expanded value of R0L and A0 are the objects of the operation.
- SUB.B Ram:8[SB],R0L
- SUB.W #2,[A0]

**[ Related Instructions ]** ADC, ADCF, ADD, SBB

**[src/dest Classified by Format]****G format**

src				dest			
R0L/R0	R0H/R1	R1L/R2	R1H/R3	R0L/R0	R0H/R1	R1L/R2	R1H/R3
A0/A0 <sup>*1</sup>	A1/A1 <sup>*1</sup>	[A0]	[A1]	A0/A0 <sup>*1</sup>	A1/A1 <sup>*1</sup>	[A0]	[A1]
dsp:8[A0]	dsp:8[A1]	dsp:8[SB]	dsp:8[FB]	dsp:8[A0]	dsp:8[A1]	dsp:8[SB]	dsp:8[FB]
dsp:16[A0]	dsp:16[A1]	dsp:16[SB]	abs16	dsp:16[A0]	dsp:16[A1]	dsp:16[SB]	abs16
dsp:20[A0]	dsp:20[A1]	abs20	#IMM	dsp:20[A0]	dsp:20[A1]	abs20	SP/SP
R2R0	R3R1	A1A0		R2R0	R3R1	A1A0	

\*1 If (.B) is selected as for the size specifier (.size), A0 or A1 cannot be chosen for *src* and *dest* simultaneously.

**S format<sup>\*2</sup>**

src				dest			
R0L	R0H	dsp:8[SB]	dsp:8[FB]	R0L	R0H	dsp:8[SB]	dsp:8[FB]
abs16	#IMM			abs16	A0	A1	
R0L <sup>*3</sup>	R0H <sup>*3</sup>	dsp:8[SB]	dsp:8[FB]	R0L <sup>*3</sup>	R0H <sup>*3</sup>	dsp:8[SB]	dsp:8[FB]
abs16	#IMM			abs16	A0	A1	

\*2 Only (.B) can be selected as for the size specifier (.size).

\*3 The same registers cannot be chosen for *src* and *dest*.

# TST

*Test*  
**TeST**

# TST

**[ Syntax ]**

TST.size                      src,dest  
 └──────────────────────────┘ B, W

**[ Instruction Code/Number of Cycles ]**

Page: 239

**[ Operation ]**dest  $\wedge$  src**[ Function ]**

- Each flag in the flag register changes state depending on the result of a logical AND of *src* and *dest*.
- If *dest* is A0 or A1 and the selected size specifier (.size) is (.B), *src* is zero-expanded to perform operation in 16 bits. If *src* is A0 or A1, the operation is performed on the 8 low-order bits of A0 or A1.

**[ Selectable src/dest ]**

src				dest			
R0L/R0	R0H/R1	R1L/R2	R1H/R3	R0L/R0	R0H/R1	R1L/R2	R1H/R3
A0/A0*1	A1/A1*1	[A0]	[A1]	A0/A0*1	A1/A1*1	[A0]	[A1]
dsp:8[A0]	dsp:8[A1]	dsp:8[SB]	dsp:8[FB]	dsp:8[A0]	dsp:8[A1]	dsp:8[SB]	dsp:8[FB]
dsp:16[A0]	dsp:16[A1]	dsp:16[SB]	abs16	dsp:16[A0]	dsp:16[A1]	dsp:16[SB]	abs16
dsp:20[A0]	dsp:20[A1]	abs20	#IMM	dsp:20[A0]	dsp:20[A1]	abs20	
R2R0	R3R1	A1A0		R2R0	R3R1	A1A0	

\*1 If (.B) is selected as the size specifier (.size), A0 or A1 cannot be chosen for *src* and *dest* simultaneously.

**[ Flag Change ]**

Flag	U	I	O	B	S	Z	D	C
Change	—	—	—	—	○	○	—	—

**Conditions**

- S : The flag is set when the operation results in MSB = 1; otherwise cleared.  
 Z : The flag is set when the operation results in 0; otherwise cleared.

**[ Description Example ]**

TST.B        #3,R0L  
 TST.B        A0,R0L  
 TST.B        R0L,A0

; 8 low-order bits of A0 and R0L are the objects of the operation.  
 ; Zero-expanded value of R0L and A0 are the objects of the operation.

**[ Related Instructions ]**    AND, OR, XOR

# UND

*Interrupt for undefined instruction*  
**UN**DEFINED instruction

# UND

[ Syntax ]  
 UND

[ Instruction Code/Number of Cycles ]  
 Page: 241

[ Operation ]

SP ← SP - 2  
 M(SP) ← (PC + 1)<sub>H</sub>, FLG  
 SP ← SP - 2  
 M(SP) ← (PC + 1)<sub>ML</sub>  
 PC ← M(FFFDC<sub>16</sub>)

[ Function ]

- This instruction generates an undefined instruction interrupt.
- The undefined instruction interrupt is nonmaskable.

[ Flag Change ]

Flag	<b>U</b>	<b>I</b>	<b>O</b>	<b>B</b>	<b>S</b>	<b>Z</b>	<b>D</b>	<b>C</b>
Change	○	○	—	—	—	—	○	—

\*1 The flags are saved to the stack area before the UND instruction is executed. After the interrupt, the flag status becomes as shown at left.

Conditions

- U : The flag is cleared.
- I : The flag is cleared.
- D : The flag is cleared.

[ Description Example ]

UND

**WAIT**

[ Syntax ]  
**WAIT**

*Wait*  
**WAIT**

**WAIT**

[ Instruction Code/Number of Cycles ]  
 Page: 241

[ Operation ]

[ Function ]

- This instruction halts program execution. Program execution is restarted when an interrupt of a higher priority level than IPL is acknowledged or a reset is generated.

[ Flag Change ]

Flag	<b>U</b>	<b>I</b>	<b>O</b>	<b>B</b>	<b>S</b>	<b>Z</b>	<b>D</b>	<b>C</b>
Change	—	—	—	—	—	—	—	—

[ Description Example ]

WAIT

# XCHG

*Exchange*  
**eXCHanGe**

# XCHG

**[ Syntax ]**

XCHG.size src,dest  
└──────────────────────────────────┘ B , W

**[ Instruction Code/Number of Cycles ]**

Page: 242

**[ Operation ]**

dest ↔ src

**[ Function ]**

- This instruction exchanges the contents of *src* and *dest*.
- If *dest* is A0 or A1 and the selected size specifier (.size) is (.B), the content of *src* is zero-expanded to 16 bits and placed in A0 or A1, and the 8 low-order bits of A0 or A1 are placed in *src*.

**[ Selectable src/dest ]**

src				dest			
R0L/R0	R0H/R1	R1L/R2	R1H/R3	R0L/R0	R0H/R1	R1L/R2	R1H/R3
A0/A0	A1/A1	[A0]	[A1]	A0/A0	A1/A1	[A0]	[A1]
dsp:8[A0]	dsp:8[A1]	dsp:8[SB]	dsp:8[FB]	dsp:8[A0]	dsp:8[A1]	dsp:8[SB]	dsp:8[FB]
dsp:16[A0]	dsp:16[A1]	dsp:16[SB]	abs16	dsp:16[A0]	dsp:16[A1]	dsp:16[SB]	abs16
dsp:20[A0]	dsp:20[A1]	abs20	#IMM	dsp:20[A0]	dsp:20[A1]	abs20	
R2R0	R3R1	A1A0	[A1A0]	R2R0	R3R1	A1A0	

**[ Flag Change ]**

Flag	U	I	O	B	S	Z	D	C
Change	—	—	—	—	—	—	—	—

**[ Description Example ]**

XCHG.B R0L,A0 ; 8 low-order bits of A0 and the zero-expanded value of R0L are exchanged.  
 XCHG.W R0,A1  
 XCHG.B R0L,[A0]

**[ Related Instructions ]** MOV, LDE, STE

# XOR

*Exclusive OR*  
**eXclusive OR**

# XOR

**[ Syntax ]**

XOR.size    src,dest  
 └──────────────────────────┘ **B, W**

**[ Instruction Code/Number of Cycles ]**

Page: 243

**[ Operation ]**

dest ← dest ∨ src

**[ Function ]**

- This instruction exclusive ORs *src* and *dest* and stores the result in *dest*.
- If *dest* is A0 or A1 and the selected size specifier (.size) is (.B), *src* is zero-expanded to perform operation in 16 bits. If *src* is A0 or A1, the operation is performed on the 8 low-order bits of A0 or A1.

**[ Selectable src/dest ]**

src				dest			
R0L/R0	R0H/R1	R1L/R2	R1H/R3	R0L/R0	R0H/R1	R1L/R2	R1H/R3
A0/A0*1	A1/A1*1	[A0]	[A1]	A0/A0*1	A1/A1*1	[A0]	[A1]
dsp:8[A0]	dsp:8[A1]	dsp:8[SB]	dsp:8[FB]	dsp:8[A0]	dsp:8[A1]	dsp:8[SB]	dsp:8[FB]
dsp:16[A0]	dsp:16[A1]	dsp:16[SB]	abs16	dsp:16[A0]	dsp:16[A1]	dsp:16[SB]	abs16
dsp:20[A0]	dsp:20[A1]	abs20	#IMM	dsp:20[A0]	dsp:20[A1]	abs20	
R2R0	R3R1	A1A0		R2R0	R3R1	A1A0	

\*1 If (.B) is selected as the size specifier (.size), A0 or A1 cannot be chosen for *src* and *dest* simultaneously.

**[ Flag Change ]**

Flag	U	I	O	B	S	Z	D	C
Change	—	—	—	—	○	○	—	—

## Conditions

- S : The flag is set when the operation results in MSB = 1; otherwise cleared.  
 Z : The flag is set when the operation results in 0; otherwise cleared.

**[ Description Example ]**

XOR.B    A0,R0L                            ; 8 low-order bits of A0 and R0L are exclusive ORed.  
 XOR.B    R0L,A0                           ; R0L is zero-expanded and exclusive ORed with A0.  
 XOR.B    #3,R0L  
 XOR.W    A0,A1

**[ Related Instructions ]**    AND, OR, TST

**This page intentionally left blank.**

# Chapter 4

---

## Instruction Codes/Number of Cycles

4.1 Guide to This Chapter

4.2 Instruction Codes/Number of Cycles

## 4.1 Guide to This Chapter

This chapter lists the instruction code and number of cycles for each op-code.

An example illustrating how to read this chapter is shown below.

Chapter 4 Instruction Code
4.2 Instruction Codes/Number of Cycles

---

(1)
LDIPL

(2)
(1) **LDIPL**#IMM

(3)

b7	0	1	1	1	1	1	0	1	1	0	1	0	1	0	IMM4	b0
----	---	---	---	---	---	---	---	---	---	---	---	---	---	---	------	----

(4)

Bytes/Cycles	2/2
--------------	-----

---

(1)
MOV

(2)
(1) **MOV**.size:G #IMM, dest

(3)

b7	0	1	1	1	0	1	0	SIZE	1	1	0	0	DEST	b0	dest code	dsp8	#IMM8
																dsp16/abs16	#IMM16

.size	SIZE
.B	0
.W	1

	dest	DEST	dest	DEST		
Rn	R0L/R0	0000	dsp:8[An]	dsp:8[A0]	1 0 0 0	
	R0H/R1	0001		dsp:8[A1]	1 0 0 1	
	R1L/R2	0010		dsp:8[SB/FB]	dsp:8[SB]	1 0 1 0
	R1H/R3	0011			dsp:8[FB]	1 0 1 1
An	A0	0100	dsp:16[An]	dsp:16[A0]	1 1 0 0	
	A1	0101		dsp:16[A1]	1 1 0 1	
[An]	[A0]	0110	dsp:16[SB]	dsp:16[SB]	1 1 1 0	
	[A1]	0111		abs16	abs16	1 1 1 1

(4)

dest	Rn	An	[An]	dsp:8[An]	dsp:8[SB/FB]	dsp:16[An]	dsp:16[SB]	abs16
Bytes/Cycles	3/2	3/2	3/3	4/3	4/3	5/3	5/3	5/3

**(1) Mnemonic**

Shows the mnemonic explained in the page.

**(2) Syntax**

Shows an instruction syntax using symbols.

**(3) Instruction code**

Shows instruction code. Portions in parentheses ( ) may be omitted depending on the selected src/dest.

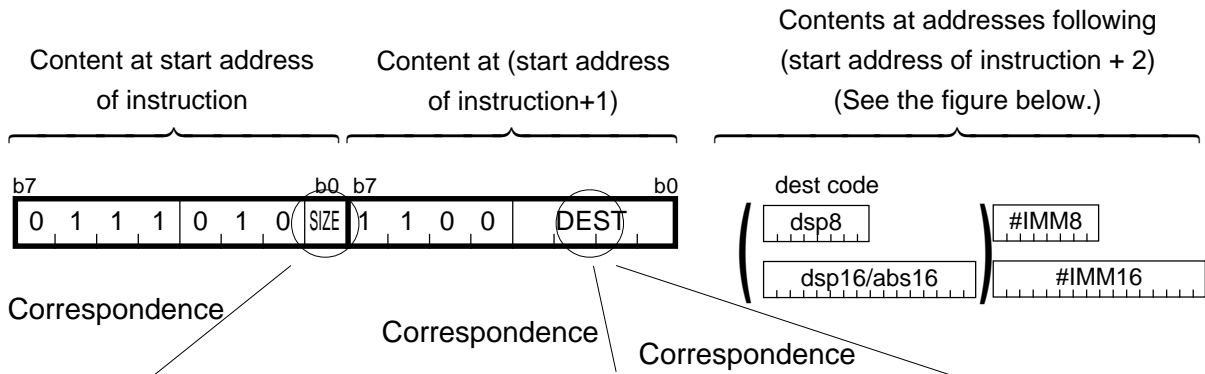

.size	SIZE
.B	0
.W	1

	dest	DEST	dest	DEST		
Rn	R0L/R0	0000	dsp:8[An]	dsp:8[A0]	1000	
	R0H/R1	0001		dsp:8[A1]	1001	
	R1L/R2	0010		dsp:8[SB/FB]	dsp:8[SB]	1010
	R1H/R3	0011			dsp:8[FB]	1011
An	A0	0100	dsp:16[An]	dsp:16[A0]	1100	
	A1	0101		dsp:16[A1]	1101	
[An]	[A0]	0110	dsp:16[SB]	dsp:16[SB]	1110	
	[A1]	0111	abs16	abs16	1111	

Contents at addresses following (start address of instruction + 2) are arranged as follows:

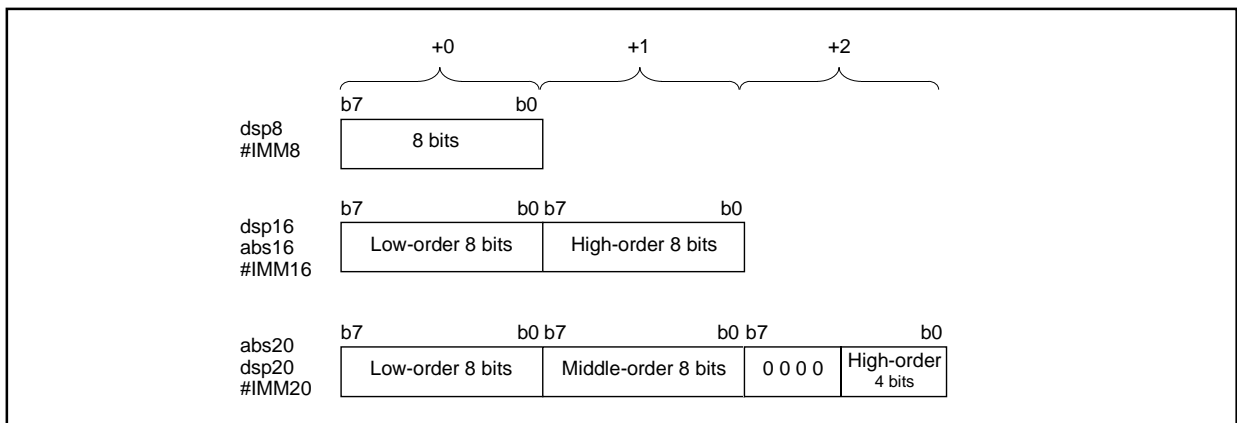

**(4) Table of cycles**

Shows the number of cycles required to execute the instruction and the number of bytes in the instruction.

The number of cycles may increase due to software wait states, etc.

The number of bytes in the instruction is indicated on the left side of the slash and the number of execution cycles is indicated on the right side.

# ABS

## (1) ABS.size dest

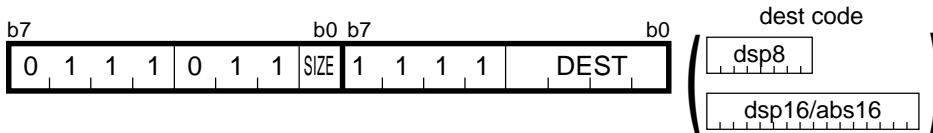

.size	SIZE
.B	0
.W	1

		dest	DEST			dest	DEST
Rn	R0L/R0		0 0 0 0	dsp:8[An]	dsp:8[A0]	1 0 0 0	
	R0H/R1		0 0 0 1		dsp:8[A1]	1 0 0 1	
	R1L/R2		0 0 1 0		dsp:8[SB/FB]	dsp:8[SB]	1 0 1 0
	R1H/R3		0 0 1 1			dsp:8[FB]	1 0 1 1
An	A0		0 1 0 0	dsp:16[An]	dsp:16[A0]	1 1 0 0	
	A1		0 1 0 1		dsp:16[A1]	1 1 0 1	
[An]	[A0]		0 1 1 0	dsp:16[SB]	dsp:16[SB]	1 1 1 0	
	[A1]		0 1 1 1	abs16	abs16	1 1 1 1	

### [ Number of Bytes/Number of Cycles ]

dest	Rn	An	[An]	dsp:8[An]	dsp:8[SB/FB]	dsp:16[An]	dsp:16[SB]	abs16
Bytes/Cycles	2/3	2/3	2/5	3/5	3/5	4/5	4/5	4/5

# ADC

## (1) ADC.size #IMM, dest

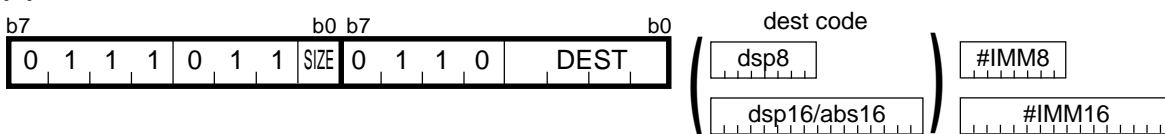

.size	SIZE
.B	0
.W	1

		dest	DEST			dest	DEST
Rn	R0L/R0		0 0 0 0	dsp:8[An]	dsp:8[A0]	1 0 0 0	
	R0H/R1		0 0 0 1		dsp:8[A1]	1 0 0 1	
	R1L/R2		0 0 1 0		dsp:8[SB/FB]	dsp:8[SB]	1 0 1 0
	R1H/R3		0 0 1 1			dsp:8[FB]	1 0 1 1
An	A0		0 1 0 0	dsp:16[An]	dsp:16[A0]	1 1 0 0	
	A1		0 1 0 1		dsp:16[A1]	1 1 0 1	
[An]	[A0]		0 1 1 0	dsp:16[SB]	dsp:16[SB]	1 1 1 0	
	[A1]		0 1 1 1	abs16	abs16	1 1 1 1	

### [ Number of Bytes/Number of Cycles ]

dest	Rn	An	[An]	dsp:8[An]	dsp:8[SB/FB]	dsp:16[An]	dsp:16[SB]	abs16
Bytes/Cycles	3/2	3/2	3/4	4/4	4/4	5/4	5/4	5/4

- If the size specifier (.size) is (.W), the number of bytes indicated is increased by 1.

## ADC

## (2) ADC.size src, dest

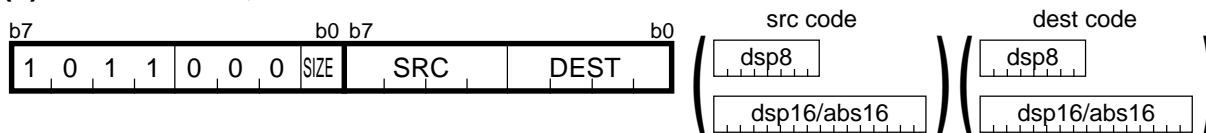

.size	SIZE
.B	0
.W	1

src/dest		SRC/DEST	src/dest		SRC/DEST
Rn	R0L/R0	0 0 0 0	dsp:8[An]	dsp:8[A0]	1 0 0 0
	R0H/R1	0 0 0 1		dsp:8[A1]	1 0 0 1
	R1L/R2	0 0 1 0	dsp:8[SB/FB]	dsp:8[SB]	1 0 1 0
	R1H/R3	0 0 1 1		dsp:8[FB]	1 0 1 1
An	A0	0 1 0 0	dsp:16[An]	dsp:16[A0]	1 1 0 0
	A1	0 1 0 1		dsp:16[A1]	1 1 0 1
[An]	[A0]	0 1 1 0	dsp:16[SB]	dsp:16[SB]	1 1 1 0
	[A1]	0 1 1 1	abs16	abs16	1 1 1 1

## [ Number of Bytes/Number of Cycles ]

src \ dest	Rn	An	[An]	dsp:8[An]	dsp:8[SB/FB]	dsp:16[An]	dsp:16[SB]	abs16
Rn	2/2	2/2	2/3	3/3	3/3	4/3	4/3	4/3
An	2/2	2/2	2/3	3/3	3/3	4/3	4/3	4/3
[An]	2/3	2/3	2/4	3/4	3/4	4/4	4/4	4/4
dsp:8[An]	3/3	3/3	3/4	4/4	4/4	5/4	5/4	5/4
dsp:8[SB/FB]	3/3	3/3	3/4	4/4	4/4	5/4	5/4	5/4
dsp:16[An]	4/3	4/3	4/4	5/4	5/4	6/4	6/4	6/4
dsp:16[SB]	4/3	4/3	4/4	5/4	5/4	6/4	6/4	6/4
abs16	4/3	4/3	4/4	5/4	5/4	6/4	6/4	6/4

# ADCF

## (1) ADCF.size dest

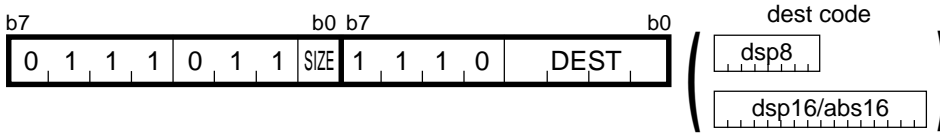

.size	SIZE
.B	0
.W	1

dest		DEST	dest		DEST
Rn	R0L/R0	0 0 0 0	dsp:8[An]	dsp:8[A0]	1 0 0 0
	R0H/R1	0 0 0 1		dsp:8[A1]	1 0 0 1
	R1L/R2	0 0 1 0	dsp:8[SB/FB]	dsp:8[SB]	1 0 1 0
	R1H/R3	0 0 1 1		dsp:8[FB]	1 0 1 1
An	A0	0 1 0 0	dsp:16[An]	dsp:16[A0]	1 1 0 0
	A1	0 1 0 1		dsp:16[A1]	1 1 0 1
[An]	[A0]	0 1 1 0	dsp:16[SB]	dsp:16[SB]	1 1 1 0
	[A1]	0 1 1 1	abs16	abs16	1 1 1 1

### [ Number of Bytes/Number of Cycles ]

dest	Rn	An	[An]	dsp:8[An]	dsp:8[SB/FB]	dsp:16[An]	dsp:16[SB]	abs16
Bytes/Cycles	2/1	2/1	2/3	3/3	3/3	4/3	4/3	4/3

# ADD

## (1) ADD.size:G #IMM, dest

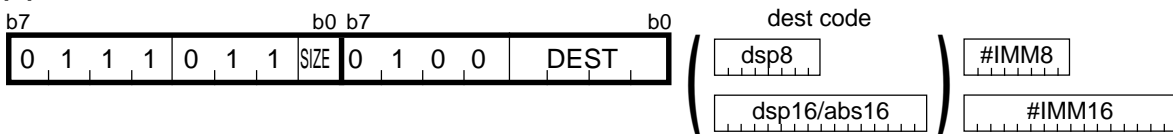

.size	SIZE
.B	0
.W	1

dest		DEST	dest		DEST
Rn	R0L/R0	0 0 0 0	dsp:8[An]	dsp:8[A0]	1 0 0 0
	R0H/R1	0 0 0 1		dsp:8[A1]	1 0 0 1
	R1L/R2	0 0 1 0	dsp:8[SB/FB]	dsp:8[SB]	1 0 1 0
	R1H/R3	0 0 1 1		dsp:8[FB]	1 0 1 1
An	A0	0 1 0 0	dsp:16[An]	dsp:16[A0]	1 1 0 0
	A1	0 1 0 1		dsp:16[A1]	1 1 0 1
[An]	[A0]	0 1 1 0	dsp:16[SB]	dsp:16[SB]	1 1 1 0
	[A1]	0 1 1 1	abs16	abs16	1 1 1 1

### [ Number of Bytes/Number of Cycles ]

dest	Rn	An	[An]	dsp:8[An]	dsp:8[SB/FB]	dsp:16[An]	dsp:16[SB]	abs16
Bytes/Cycles	3/2	3/2	3/4	4/4	4/4	5/4	5/4	5/4

- If the size specifier (.size) is (.W), the number of bytes indicated is increased by 1.

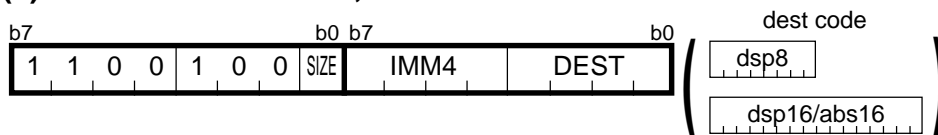
**ADD****(2) ADD.size:Q #IMM, dest**

.size	SIZE
.B	0
.W	1

#IMM	IMM4	#IMM	IMM4
0	0 0 0 0	-8	1 0 0 0
+1	0 0 0 1	-7	1 0 0 1
+2	0 0 1 0	-6	1 0 1 0
+3	0 0 1 1	-5	1 0 1 1
+4	0 1 0 0	-4	1 1 0 0
+5	0 1 0 1	-3	1 1 0 1
+6	0 1 1 0	-2	1 1 1 0
+7	0 1 1 1	-1	1 1 1 1

dest		DEST	dest		DEST
Rn	R0L/R0	0 0 0 0	dsp:8[An]	dsp:8[A0]	1 0 0 0
	R0H/R1	0 0 0 1		dsp:8[A1]	1 0 0 1
	R1L/R2	0 0 1 0	dsp:8[SB/FB]	dsp:8[SB]	1 0 1 0
	R1H/R3	0 0 1 1		dsp:8[FB]	1 0 1 1
An	A0	0 1 0 0	dsp:16[An]	dsp:16[A0]	1 1 0 0
	A1	0 1 0 1		dsp:16[A1]	1 1 0 1
[An]	[A0]	0 1 1 0	dsp:16[SB]	dsp:16[SB]	1 1 1 0
	[A1]	0 1 1 1	abs16	abs16	1 1 1 1

**[ Number of Bytes/Number of Cycles ]**

dest	Rn	An	[An]	dsp:8[An]	dsp:8[SB/FB]	dsp:16[An]	dsp:16[SB]	abs16
Bytes/Cycles	2/1	2/1	2/3	3/3	3/3	4/3	4/3	4/3

## ADD

### (3) ADD.B:S #IMM8, dest

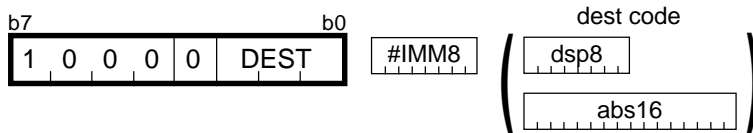

dest		DEST
Rn	R0H	0 1 1
	R0L	1 0 0
dsp:8[SB/FB]	dsp:8[SB]	1 0 1
	dsp:8[FB]	1 1 0
abs16	abs16	1 1 1

#### [ Number of Bytes/Number of Cycles ]

dest	Rn	dsp:8[SB/FB]	abs16
Bytes/Cycles	2/1	3/3	4/3

# ADD

## (4) ADD.size:G src, dest

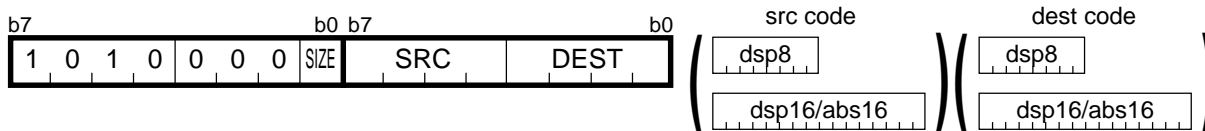

.size	SIZE
.B	0
.W	1

src/dest		SRC/DEST	src/dest		SRC/DEST
Rn	R0L/R0	0 0 0 0	dsp:8[An]	dsp:8[A0]	1 0 0 0
	R0H/R1	0 0 0 1		dsp:8[A1]	1 0 0 1
	R1L/R2	0 0 1 0	dsp:8[SB/FB]	dsp:8[SB]	1 0 1 0
	R1H/R3	0 0 1 1		dsp:8[FB]	1 0 1 1
An	A0	0 1 0 0	dsp:16[An]	dsp:16[A0]	1 1 0 0
	A1	0 1 0 1		dsp:16[A1]	1 1 0 1
[An]	[A0]	0 1 1 0	dsp:16[SB]	dsp:16[SB]	1 1 1 0
	[A1]	0 1 1 1	abs16	abs16	1 1 1 1

### [ Number of Bytes/Number of Cycles ]

src \ dest	Rn	An	[An]	dsp:8[An]	dsp:8[SB/FB]	dsp:16[An]	dsp:16[SB]	abs16
Rn	2/2	2/2	2/3	3/3	3/3	4/3	4/3	4/3
An	2/2	2/2	2/3	3/3	3/3	4/3	4/3	4/3
[An]	2/3	2/3	2/4	3/4	3/4	4/4	4/4	4/4
dsp:8[An]	3/3	3/3	3/4	4/4	4/4	5/4	5/4	5/4
dsp:8[SB/FB]	3/3	3/3	3/4	4/4	4/4	5/4	5/4	5/4
dsp:16[An]	4/3	4/3	4/4	5/4	5/4	6/4	6/4	6/4
dsp:16[SB]	4/3	4/3	4/4	5/4	5/4	6/4	6/4	6/4
abs16	4/3	4/3	4/4	5/4	5/4	6/4	6/4	6/4

## ADD

### (5) ADD.B:S src, R0L/R0H

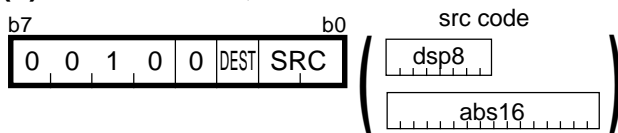

src		SRC
Rn	R0L/R0H	0 0
dsp:8[SB/FB]	dsp:8[SB]	0 1
	dsp:8[FB]	1 0
abs16	abs16	1 1

dest	DEST
R0L	0
R0H	1

#### [ Number of Bytes/Number of Cycles ]

src	Rn	dsp:8[SB/FB]	abs16
Bytes/Cycles	1/2	2/3	3/3

## ADD

### (6) ADD.size:G #IMM, SP

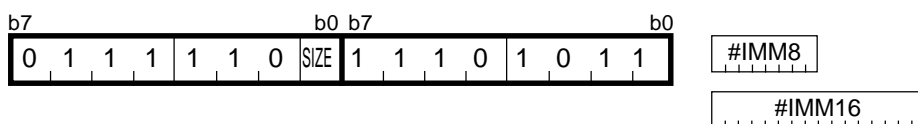

.size	SIZE
.B	0
.W	1

#### [ Number of Bytes/Number of Cycles ]

Bytes/Cycles	3/2
--------------	-----

- If the size specifier (.size) is (.W), the number of bytes indicated is increased by 1.

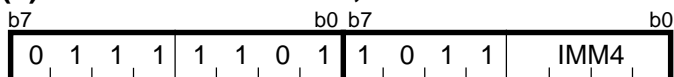
**ADD****(7) ADD.size:Q #IMM, SP**

- The instruction code is the same regardless of whether (.B) or (.W) is selected as the size specifier (.size).

#IMM	IMM4	#IMM	IMM4
0	0 0 0 0	-8	1 0 0 0
+1	0 0 0 1	-7	1 0 0 1
+2	0 0 1 0	-6	1 0 1 0
+3	0 0 1 1	-5	1 0 1 1
+4	0 1 0 0	-4	1 1 0 0
+5	0 1 0 1	-3	1 1 0 1
+6	0 1 1 0	-2	1 1 1 0
+7	0 1 1 1	-1	1 1 1 1

**[ Number of Bytes/Number of Cycles ]**

Bytes/Cycles	2/1
--------------	-----

# ADJNZ

## (1) ADJNZ.size #IMM, dest, label

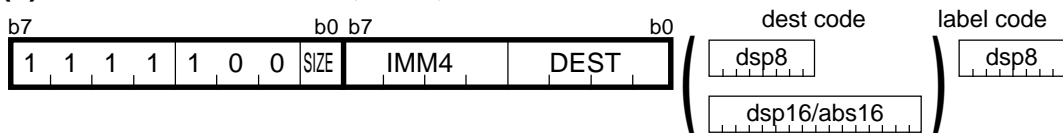

dsp8 (label code) = address indicated by label – (start address of instruction + 2)

.size	SIZE
.B	0
.W	1

#IMM	IMM4	#IMM	IMM4
0	0 0 0 0	-8	1 0 0 0
+1	0 0 0 1	-7	1 0 0 1
+2	0 0 1 0	-6	1 0 1 0
+3	0 0 1 1	-5	1 0 1 1
+4	0 1 0 0	-4	1 1 0 0
+5	0 1 0 1	-3	1 1 0 1
+6	0 1 1 0	-2	1 1 1 0
+7	0 1 1 1	-1	1 1 1 1

dest		DEST	dest		DEST
Rn	R0L/R0	0 0 0 0	dsp:8[An]	dsp:8[A0]	1 0 0 0
	R0H/R1	0 0 0 1		dsp:8[A1]	1 0 0 1
	R1L/R2	0 0 1 0	dsp:8[SB/FB]	dsp:8[SB]	1 0 1 0
	R1H/R3	0 0 1 1		dsp:8[FB]	1 0 1 1
An	A0	0 1 0 0	dsp:16[An]	dsp:16[A0]	1 1 0 0
	A1	0 1 0 1		dsp:16[A1]	1 1 0 1
[An]	[A0]	0 1 1 0	dsp:16[SB]	dsp:16[SB]	1 1 1 0
	[A1]	0 1 1 1	abs16	abs16	1 1 1 1

### [ Number of Bytes/Number of Cycles ]

dest	Rn	An	[An]	dsp:8[An]	dsp:8[SB/FB]	dsp:16[An]	dsp:16[SB]	abs16
Bytes/Cycles	3/3	3/3	3/5	4/5	4/5	5/5	5/5	5/5

- If the program branches to a label, the number of cycles indicated is increased by 4.

# AND

## (1) AND.size:G #IMM, dest

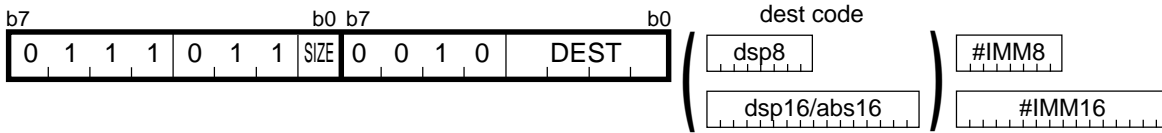

.size	SIZE
.B	0
.W	1

dest		DEST	dest		DEST	
Rn	R0L/R0	0 0 0 0	dsp:8[An]	dsp:8[A0]	1 0 0 0	
	R0H/R1	0 0 0 1		dsp:8[A1]	1 0 0 1	
	R1L/R2	0 0 1 0		dsp:8[SB/FB]	dsp:8[SB]	1 0 1 0
	R1H/R3	0 0 1 1			dsp:8[FB]	1 0 1 1
An	A0	0 1 0 0	dsp:16[An]	dsp:16[A0]	1 1 0 0	
	A1	0 1 0 1		dsp:16[A1]	1 1 0 1	
[An]	[A0]	0 1 1 0	dsp:16[SB]	dsp:16[SB]	1 1 1 0	
	[A1]	0 1 1 1	abs16	abs16	1 1 1 1	

### [ Number of Bytes/Number of Cycles ]

dest	Rn	An	[An]	dsp:8[An]	dsp:8[SB/FB]	dsp:16[An]	dsp:16[SB]	abs16
Bytes/Cycles	3/2	3/2	3/4	4/4	4/4	5/4	5/4	5/4

- If the size specifier (.size) is (.W), the number of bytes indicated is increased by 1.

# AND

## (2) AND.B:S #IMM8, dest

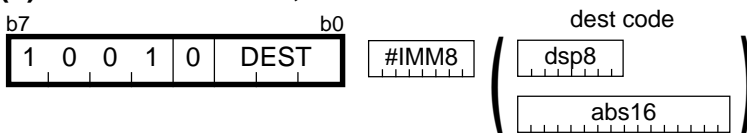

dest		DEST
Rn	R0H	0 1 1
	R0L	1 0 0
dsp:8[SB/FB]	dsp:8[SB]	1 0 1
	dsp:8[FB]	1 1 0
abs16	abs16	1 1 1

### [ Number of Bytes/Number of Cycles ]

dest	Rn	dsp:8[SB/FB]	abs16
Bytes/Cycles	2/1	3/3	4/3

## AND

### (3) AND.size:G src, dest

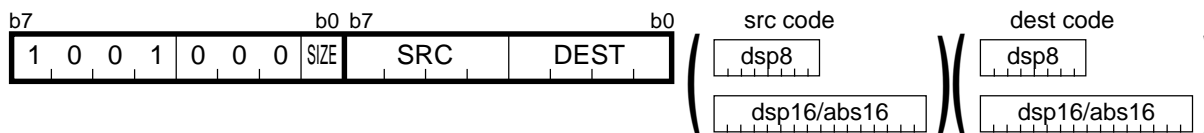

.size	SIZE
.B	0
.W	1

src/dest		SRC/DEST	src/dest		SRC/DEST
Rn	R0L/R0	0 0 0 0	dsp:8[An]	dsp:8[A0]	1 0 0 0
	R0H/R1	0 0 0 1		dsp:8[A1]	1 0 0 1
	R1L/R2	0 0 1 0	dsp:8[SB/FB]	dsp:8[SB]	1 0 1 0
	R1H/R3	0 0 1 1		dsp:8[FB]	1 0 1 1
An	A0	0 1 0 0	dsp:16[An]	dsp:16[A0]	1 1 0 0
	A1	0 1 0 1		dsp:16[A1]	1 1 0 1
[An]	[A0]	0 1 1 0	dsp:16[SB]	dsp:16[SB]	1 1 1 0
	[A1]	0 1 1 1	abs16	abs16	1 1 1 1

#### [ Number of Bytes/Number of Cycles ]

src \ dest	Rn	An	[An]	dsp:8[An]	dsp:8[SB/FB]	dsp:16[An]	dsp:16[SB]	abs16
Rn	2/2	2/2	2/3	3/3	3/3	4/3	4/3	4/3
An	2/2	2/2	2/3	3/3	3/3	4/3	4/3	4/3
[An]	2/3	2/3	2/4	3/4	3/4	4/4	4/4	4/4
dsp:8[An]	3/3	3/3	3/4	4/4	4/4	5/4	5/4	5/4
dsp:8[SB/FB]	3/3	3/3	3/4	4/4	4/4	5/4	5/4	5/4
dsp:16[An]	4/3	4/3	4/4	5/4	5/4	6/4	6/4	6/4
dsp:16[SB]	4/3	4/3	4/4	5/4	5/4	6/4	6/4	6/4
abs16	4/3	4/3	4/4	5/4	5/4	6/4	6/4	6/4

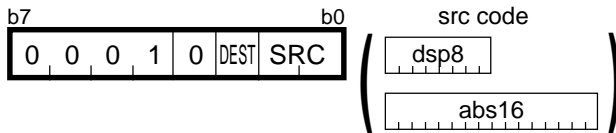
**AND****(4) AND.B:S src, R0L/R0H**

src		SRC
Rn	R0L/R0H	0 0
dsp:8[SB/FB]	dsp:8[SB]	0 1
	dsp:8[FB]	1 0
abs16	abs16	1 1

dest	DEST
R0L	0
R0H	1

**[ Number of Bytes/Number of Cycles ]**

src	Rn	dsp:8[SB/FB]	abs16
Bytes/Cycles	1/2	2/3	3/3

# BAND

## (1) BAND src

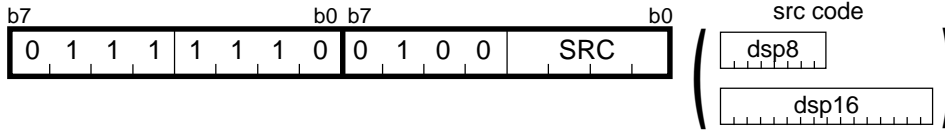

src		SRC	src		SRC
bit,Rn	bit,R0	0 0 0 0	base:8[An]	base:8[A0]	1 0 0 0
	bit,R1	0 0 0 1		base:8[A1]	1 0 0 1
	bit,R2	0 0 1 0	bit,base:8	bit,base:8[SB]	1 0 1 0
	bit,R3	0 0 1 1	[SB/FB]	bit,base:8[FB]	1 0 1 1
bit,An	bit,A0	0 1 0 0	base:16[An]	base:16[A0]	1 1 0 0
	bit,A1	0 1 0 1		base:16[A1]	1 1 0 1
[An]	[A0]	0 1 1 0	bit,base:16[SB]	bit,base:16[SB]	1 1 1 0
	[A1]	0 1 1 1	bit,base:16	bit,base:16	1 1 1 1

### [ Number of Bytes/Number of Cycles ]

src	bit,Rn	bit,An	[An]	base:8 [An]	bit,base:8 [SB/FB]	base:16 [An]	bit,base:16 [SB]	bit,base:16
Bytes/Cycles	3/3	3/3	2/7	3/7	3/4	4/7	4/4	4/4

# BCLR

## (1) BCLR:G dest

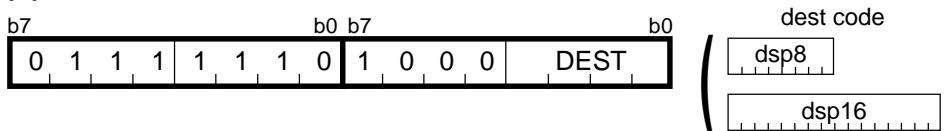

dest		DEST	dest		DEST
bit,Rn	bit,R0	0 0 0 0	base:8[An]	base:8[A0]	1 0 0 0
	bit,R1	0 0 0 1		base:8[A1]	1 0 0 1
	bit,R2	0 0 1 0	bit,base:8	bit,base:8[SB]	1 0 1 0
	bit,R3	0 0 1 1	[SB/FB]	bit,base:8[FB]	1 0 1 1
bit,An	bit,A0	0 1 0 0	base:16[An]	base:16[A0]	1 1 0 0
	bit,A1	0 1 0 1		base:16[A1]	1 1 0 1
[An]	[A0]	0 1 1 0	bit,base:16[SB]	bit,base:16[SB]	1 1 1 0
	[A1]	0 1 1 1	bit,base:16	bit,base:16	1 1 1 1

### [ Number of Bytes/Number of Cycles ]

dest	bit,Rn	bit,An	[An]	base:8 [An]	bit,base:8 [SB/FB]	base:16 [An]	bit,base:16 [SB]	bit,base:16
Bytes/Cycles	3/2	3/2	2/6	3/6	3/3	4/6	4/3	4/3

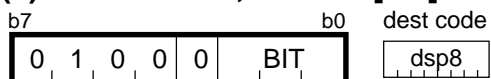
**BCLR****(2) BCLR:S bit, base:11[SB]****[ Number of Bytes/Number of Cycles ]**

Bytes/Cycles	2/3
--------------	-----

# BM*Cnd*

## (1) BM*Cnd* dest



dest		DEST	dest		DEST
bit,Rn	bit,R0	0 0 0 0	base:8[An]	base:8[A0]	1 0 0 0
	bit,R1	0 0 0 1		base:8[A1]	1 0 0 1
	bit,R2	0 0 1 0	bit,base:8	bit,base:8[SB]	1 0 1 0
	bit,R3	0 0 1 1	[SB/FB]	bit,base:8[FB]	1 0 1 1
bit,An	bit,A0	0 1 0 0	base:16[An]	base:16[A0]	1 1 0 0
	bit,A1	0 1 0 1		base:16[A1]	1 1 0 1
[An]	[A0]	0 1 1 0	bit,base:16[SB]	bit,base:16[SB]	1 1 1 0
	[A1]	0 1 1 1	bit,base:16	bit,base:16	1 1 1 1

<i>Cnd</i>	CND	<i>Cnd</i>	CND
GEU/C	0 0 0 0 0 0 0 0	LTU/NC	1 1 1 1 1 0 0 0
GTU	0 0 0 0 0 0 0 1	LEU	1 1 1 1 1 0 0 1
EQ/Z	0 0 0 0 0 0 1 0	NE/NZ	1 1 1 1 1 0 1 0
N	0 0 0 0 0 0 1 1	PZ	1 1 1 1 1 0 1 1
LE	0 0 0 0 0 1 0 0	GT	1 1 1 1 1 1 0 0
O	0 0 0 0 0 1 0 1	NO	1 1 1 1 1 1 0 1
GE	0 0 0 0 0 1 1 0	LT	1 1 1 1 1 1 1 0

### [ Number of Bytes/Number of Cycles ]

dest	bit,Rn	bit,An	[An]	base:8 [An]	bit,base:8 [SB/FB]	base:16 [An]	bit,base:16 [SB]	bit,base:16
Bytes/Cycles	4/6	4/6	3/10	4/10	4/7	5/10	5/7	5/7

## BM*Cnd*

### (2) BM*Cnd* C

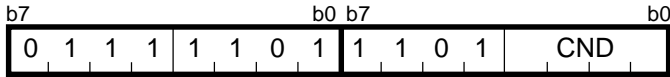

<i>Cnd</i>	CND	<i>Cnd</i>	CND
GEU/C	0 0 0 0	PZ	0 1 1 1
GTU	0 0 0 1	LE	1 0 0 0
EQ/Z	0 0 1 0	O	1 0 0 1
N	0 0 1 1	GE	1 0 1 0
LTU/NC	0 1 0 0	GT	1 1 0 0
LEU	0 1 0 1	NO	1 1 0 1
NE/NZ	0 1 1 0	LT	1 1 1 0

#### [ Number of Bytes/Number of Cycles ]

Bytes/Cycles	2/1
--------------	-----

- If the condition is true, the number of cycles indicated is increased by 1.

## BNAND

### (1) BNAND src

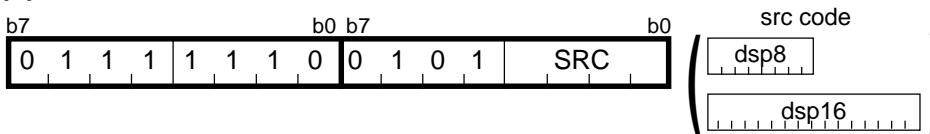

src		SRC	src		SRC
bit,Rn	bit,R0	0 0 0 0	base:8[An]	base:8[A0]	1 0 0 0
	bit,R1	0 0 0 1		base:8[A1]	1 0 0 1
	bit,R2	0 0 1 0	bit,base:8 [SB/FB]	bit,base:8[SB]	1 0 1 0
	bit,R3	0 0 1 1		bit,base:8[FB]	1 0 1 1
bit,An	bit,A0	0 1 0 0	base:16[An]	base:16[A0]	1 1 0 0
	bit,A1	0 1 0 1		base:16[A1]	1 1 0 1
[An]	[A0]	0 1 1 0	bit,base:16[SB] bit,base:16	bit,base:16[SB]	1 1 1 0
	[A1]	0 1 1 1		bit,base:16	1 1 1 1

#### [ Number of Bytes/Number of Cycles ]

src	bit,Rn	bit,An	[An]	base:8 [An]	bit,base:8 [SB/FB]	base:16 [An]	bit,base:16 [SB]	bit,base:16
Bytes/Cycles	3/3	3/3	2/7	3/7	3/4	4/7	4/4	4/4

# BNOR

## (1) BNOR src

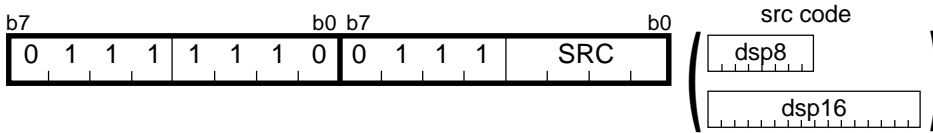

src		SRC	src		SRC
bit,Rn	bit,R0	0 0 0 0	base:8[An]	base:8[A0]	1 0 0 0
	bit,R1	0 0 0 1		base:8[A1]	1 0 0 1
	bit,R2	0 0 1 0	bit,base:8	bit,base:8[SB]	1 0 1 0
	bit,R3	0 0 1 1	[SB/FB]	bit,base:8[FB]	1 0 1 1
bit,An	bit,A0	0 1 0 0	base:16[An]	base:16[A0]	1 1 0 0
	bit,A1	0 1 0 1		base:16[A1]	1 1 0 1
[An]	[A0]	0 1 1 0	bit,base:16[SB]	bit,base:16[SB]	1 1 1 0
	[A1]	0 1 1 1	bit,base:16	bit,base:16	1 1 1 1

### [ Number of Bytes/Number of Cycles ]

src	bit,Rn	bit,An	[An]	base:8 [An]	bit,base:8 [SB/FB]	base:16 [An]	bit,base:16 [SB]	bit,base:16
Bytes/Cycles	3/3	3/3	2/7	3/7	3/4	4/7	4/4	4/4

# BNOT

## (1) BNOT:G dest

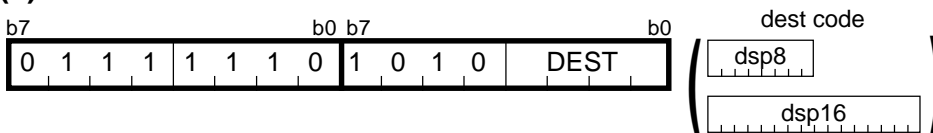

dest		DEST	dest		DEST
bit,Rn	bit,R0	0 0 0 0	base:8[An]	base:8[A0]	1 0 0 0
	bit,R1	0 0 0 1		base:8[A1]	1 0 0 1
	bit,R2	0 0 1 0	bit,base:8	bit,base:8[SB]	1 0 1 0
	bit,R3	0 0 1 1	[SB/FB]	bit,base:8[FB]	1 0 1 1
bit,An	bit,A0	0 1 0 0	base:16[An]	base:16[A0]	1 1 0 0
	bit,A1	0 1 0 1		base:16[A1]	1 1 0 1
[An]	[A0]	0 1 1 0	bit,base:16[SB]	bit,base:16[SB]	1 1 1 0
	[A1]	0 1 1 1	bit,base:16	bit,base:16	1 1 1 1

### [ Number of Bytes/Number of Cycles ]

dest	bit,Rn	bit,An	[An]	base:8 [An]	bit,base:8 [SB/FB]	base:16 [An]	bit,base:16 [SB]	bit,base:16
Bytes/Cycles	3/2	3/2	2/6	3/6	3/3	4/6	4/3	4/3

# BNOT

## (2) BNOT:S bit, base:11[SB]

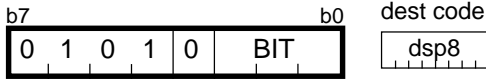

[ Number of Bytes/Number of Cycles ]

Bytes/Cycles	2/3
--------------	-----

# BNTST

## (1) BNTST src

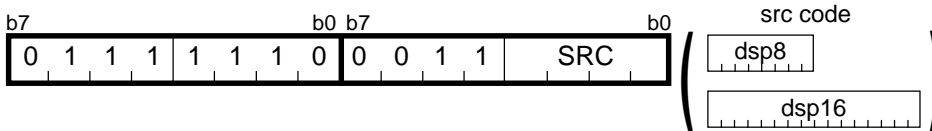

src		SRC	src		SRC
bit,Rn	bit,R0	0 0 0 0	base:8[An]	base:8[A0]	1 0 0 0
	bit,R1	0 0 0 1		base:8[A1]	1 0 0 1
	bit,R2	0 0 1 0	bit,base:8 [SB/FB]	bit,base:8[SB]	1 0 1 0
	bit,R3	0 0 1 1		bit,base:8[FB]	1 0 1 1
bit,An	bit,A0	0 1 0 0	base:16[An]	base:16[A0]	1 1 0 0
	bit,A1	0 1 0 1		base:16[A1]	1 1 0 1
[An]	[A0]	0 1 1 0	bit,base:16[SB]	bit,base:16[SB]	1 1 1 0
	[A1]	0 1 1 1	bit,base:16	bit,base:16	1 1 1 1

[ Number of Bytes/Number of Cycles ]

src	bit,Rn	bit,An	[An]	base:8 [An]	bit,base:8 [SB/FB]	base:16 [An]	bit,base:16 [SB]	bit,base:16
Bytes/Cycles	3/3	3/3	2/7	3/7	3/4	4/7	4/4	4/4

# BNXOR

## (1) BNXOR src

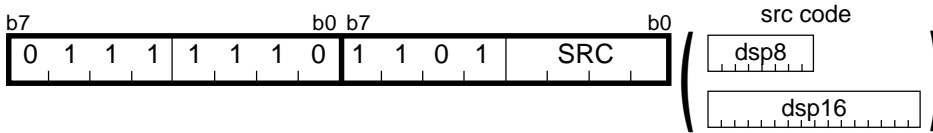

src		SRC	src		SRC
bit,Rn	bit,R0	0 0 0 0	base:8[An]	base:8[A0]	1 0 0 0
	bit,R1	0 0 0 1		base:8[A1]	1 0 0 1
	bit,R2	0 0 1 0	bit,base:8	bit,base:8[SB]	1 0 1 0
	bit,R3	0 0 1 1	[SB/FB]	bit,base:8[FB]	1 0 1 1
bit,An	bit,A0	0 1 0 0	base:16[An]	base:16[A0]	1 1 0 0
	bit,A1	0 1 0 1		base:16[A1]	1 1 0 1
[An]	[A0]	0 1 1 0	bit,base:16[SB]	bit,base:16[SB]	1 1 1 0
	[A1]	0 1 1 1	bit,base:16	bit,base:16	1 1 1 1

### [ Number of Bytes/Number of Cycles ]

src	bit,Rn	bit,An	[An]	base:8 [An]	bit,base:8 [SB/FB]	base:16 [An]	bit,base:16 [SB]	bit,base:16
Bytes/Cycles	3/3	3/3	2/7	3/7	3/4	4/7	4/4	4/4

# BOR

## (1) BOR src

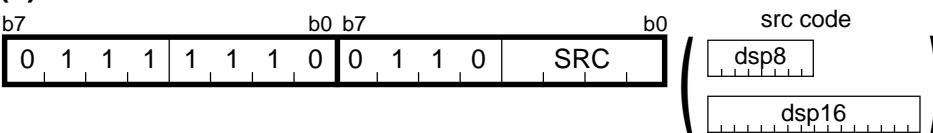

src		SRC	src		SRC
bit,Rn	bit,R0	0 0 0 0	base:8[An]	base:8[A0]	1 0 0 0
	bit,R1	0 0 0 1		base:8[A1]	1 0 0 1
	bit,R2	0 0 1 0	bit,base:8	bit,base:8[SB]	1 0 1 0
	bit,R3	0 0 1 1	[SB/FB]	bit,base:8[FB]	1 0 1 1
bit,An	bit,A0	0 1 0 0	base:16[An]	base:16[A0]	1 1 0 0
	bit,A1	0 1 0 1		base:16[A1]	1 1 0 1
[An]	[A0]	0 1 1 0	bit,base:16[SB]	bit,base:16[SB]	1 1 1 0
	[A1]	0 1 1 1	bit,base:16	bit,base:16	1 1 1 1

### [ Number of Bytes/Number of Cycles ]

src	bit,Rn	bit,An	[An]	base:8 [An]	bit,base:8 [SB/FB]	base:16 [An]	bit,base:16 [SB]	bit,base:16
Bytes/Cycles	3/3	3/3	2/7	3/7	3/4	4/7	4/4	4/4

# BRK

## (1) BRK

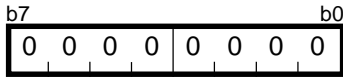

### [ Number of Bytes/Number of Cycles ]

Bytes/Cycles	1/27
--------------	------

- If the target address of the BRK interrupt is specified using the interrupt table register (INTB), the number of cycles shown in the table increases by two. In this case, set FF16 in addresses FFFE416 through FFFE716.

# BSET

## (1) BSET:G dest

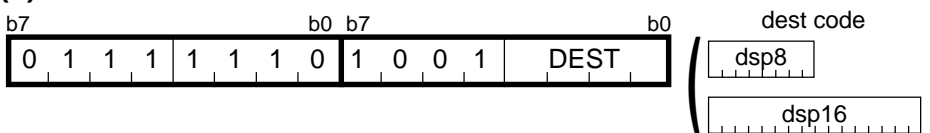

dest		DEST	dest		DEST
bit,Rn	bit,R0	0 0 0 0	base:8[An]	base:8[A0]	1 0 0 0
	bit,R1	0 0 0 1		base:8[A1]	1 0 0 1
	bit,R2	0 0 1 0	bit,base:8 [SB/FB]	bit,base:8[SB]	1 0 1 0
	bit,R3	0 0 1 1		bit,base:8[FB]	1 0 1 1
bit,An	bit,A0	0 1 0 0	base:16[An]	base:16[A0]	1 1 0 0
	bit,A1	0 1 0 1		base:16[A1]	1 1 0 1
[An]	[A0]	0 1 1 0	bit,base:16[SB] bit,base:16	bit,base:16[SB]	1 1 1 0
	[A1]	0 1 1 1		bit,base:16	1 1 1 1

### [ Number of Bytes/Number of Cycles ]

dest	bit,Rn	bit,An	[An]	base:8 [An]	bit,base:8 [SB/FB]	base:16 [An]	bit,base:16 [SB]	bit,base:16
Bytes/Cycles	3/2	3/2	2/6	3/6	3/3	4/6	4/3	4/3

## BSET

(2) BSET:S bit, base:11[SB]

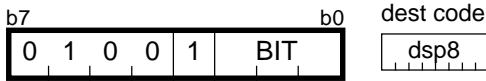

[ Number of Bytes/Number of Cycles ]

Bytes/Cycles	2/3
--------------	-----

## BTST

(1) BTST:G src

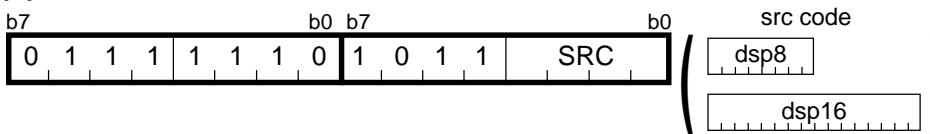

src		SRC	src		SRC
bit,Rn	bit,R0	0 0 0 0	base:8[An]	base:8[A0]	1 0 0 0
	bit,R1	0 0 0 1		base:8[A1]	1 0 0 1
	bit,R2	0 0 1 0	bit,base:8	bit,base:8[SB]	1 0 1 0
	bit,R3	0 0 1 1	[SB/FB]	bit,base:8[FB]	1 0 1 1
bit,An	bit,A0	0 1 0 0	base:16[An]	base:16[A0]	1 1 0 0
	bit,A1	0 1 0 1		base:16[A1]	1 1 0 1
[An]	[A0]	0 1 1 0	bit,base:16[SB]	bit,base:16[SB]	1 1 1 0
	[A1]	0 1 1 1	bit,base:16	bit,base:16	1 1 1 1

[ Number of Bytes/Number of Cycles ]

src	bit,Rn	bit,An	[An]	base:8 [An]	bit,base:8 [SB/FB]	base:16 [An]	bit,base:16 [SB]	bit,base:16
Bytes/Cycles	3/2	3/2	2/6	3/6	3/3	4/6	4/3	4/3

# BTST

## (2) BTST:S bit, base:11[SB]

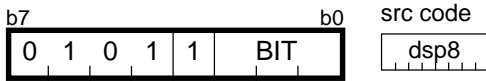

[ Number of Bytes/Number of Cycles ]

Bytes/Cycles	2/3
--------------	-----

# BTSTC

## (1) BTSTC dest

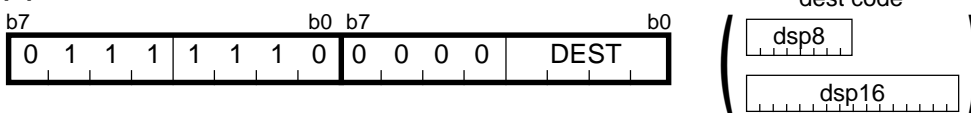

dest		DEST	dest		DEST
bit,Rn	bit,R0	0 0 0 0	base:8[An]	base:8[A0]	1 0 0 0
	bit,R1	0 0 0 1		base:8[A1]	1 0 0 1
	bit,R2	0 0 1 0	bit,base:8 [SB/FB]	bit,base:8[SB]	1 0 1 0
	bit,R3	0 0 1 1		bit,base:8[FB]	1 0 1 1
bit,An	bit,A0	0 1 0 0	base:16[An]	base:16[A0]	1 1 0 0
	bit,A1	0 1 0 1		base:16[A1]	1 1 0 1
[An]	[A0]	0 1 1 0	bit,base:16[SB] bit,base:16	bit,base:16[SB]	1 1 1 0
	[A1]	0 1 1 1		bit,base:16	1 1 1 1

[ Number of Bytes/Number of Cycles ]

dest	bit,Rn	bit,An	[An]	base:8 [An]	bit,base:8 [SB/FB]	base:16 [An]	bit,base:16 [SB]	bit,base:16
Bytes/Cycles	3/3	3/3	2/7	3/7	3/4	4/7	4/4	4/4

# BTSTS

## (1) BTSTS dest

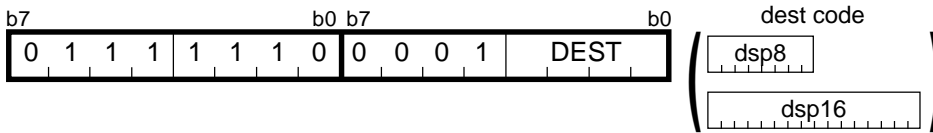

dest		SRC	dest		SRC	
bit,Rn	bit,R0	0 0 0 0	base:8[An]	base:8[A0]	1 0 0 0	
	bit,R1	0 0 0 1		base:8[A1]	1 0 0 1	
	bit,R2	0 0 1 0		bit,base:8	bit,base:8[SB]	1 0 1 0
	bit,R3	0 0 1 1		[SB/FB]	bit,base:8[FB]	1 0 1 1
bit,An	bit,A0	0 1 0 0	base:16[An]	base:16[A0]	1 1 0 0	
	bit,A1	0 1 0 1		base:16[A1]	1 1 0 1	
[An]	[A0]	0 1 1 0	bit,base:16[SB]	bit,base:16[SB]	1 1 1 0	
	[A1]	0 1 1 1	bit,base:16	bit,base:16	1 1 1 1	

### [ Number of Bytes/Number of Cycles ]

dest	bit,Rn	bit,An	[An]	base:8 [An]	bit,base:8 [SB/FB]	base:16 [An]	bit,base:16 [SB]	bit,base:16
Bytes/Cycles	3/3	3/3	2/7	3/7	3/4	4/7	4/4	4/4

# BXOR

## (1) BXOR src

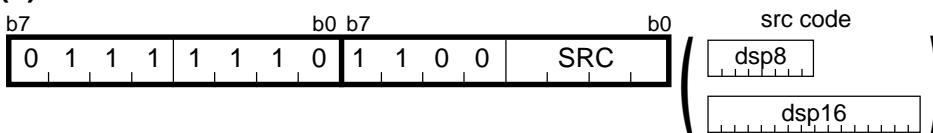

src		SRC	src		SRC	
bit,Rn	bit,R0	0 0 0 0	base:8[An]	base:8[A0]	1 0 0 0	
	bit,R1	0 0 0 1		base:8[A1]	1 0 0 1	
	bit,R2	0 0 1 0		bit,base:8	bit,base:8[SB]	1 0 1 0
	bit,R3	0 0 1 1		[SB/FB]	bit,base:8[FB]	1 0 1 1
bit,An	bit,A0	0 1 0 0	base:16[An]	base:16[A0]	1 1 0 0	
	bit,A1	0 1 0 1		base:16[A1]	1 1 0 1	
[An]	[A0]	0 1 1 0	bit,base:16[SB]	bit,base:16[SB]	1 1 1 0	
	[A1]	0 1 1 1	bit,base:16	bit,base:16	1 1 1 1	

### [ Number of Bytes/Number of Cycles ]

src	bit,Rn	bit,An	[An]	base:8 [An]	bit,base:8 [SB/FB]	base:16 [An]	bit,base:16 [SB]	bit,base:16
Bytes/Cycles	3/3	3/3	2/7	3/7	3/4	4/7	4/4	4/4

# CMP

## (1) CMP.size:G #IMM, dest

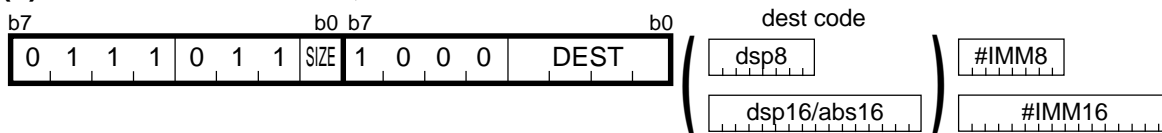

.size	SIZE
.B	0
.W	1

dest		DEST	dest		DEST
Rn	R0L/R0	0 0 0 0	dsp:8[An]	dsp:8[A0]	1 0 0 0
	R0H/R1	0 0 0 1		dsp:8[A1]	1 0 0 1
	R1L/R2	0 0 1 0	dsp:8[SB/FB]	dsp:8[SB]	1 0 1 0
	R1H/R3	0 0 1 1		dsp:8[FB]	1 0 1 1
An	A0	0 1 0 0	dsp:16[An]	dsp:16[A0]	1 1 0 0
	A1	0 1 0 1		dsp:16[A1]	1 1 0 1
[An]	[A0]	0 1 1 0	dsp:16[SB]	dsp:16[SB]	1 1 1 0
	[A1]	0 1 1 1	abs16	abs16	1 1 1 1

### [ Number of Bytes/Number of Cycles ]

dest	Rn	An	[An]	dsp:8[An]	dsp:8[SB/FB]	dsp:16[An]	dsp:16[SB]	abs16
Bytes/Cycles	3/2	3/2	3/4	4/4	4/4	5/4	5/4	5/4

- If the size specifier (.size) is (.W), the number of bytes indicated is increased by 1.

# CMP

(2) **CMP.size:Q #IMM, dest**

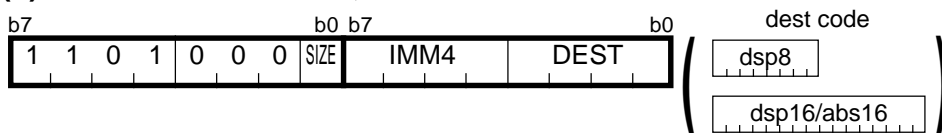

.size	SIZE
.B	0
.W	1

#IMM	IMM4	#IMM	IMM4
0	0 0 0 0	-8	1 0 0 0
+1	0 0 0 1	-7	1 0 0 1
+2	0 0 1 0	-6	1 0 1 0
+3	0 0 1 1	-5	1 0 1 1
+4	0 1 0 0	-4	1 1 0 0
+5	0 1 0 1	-3	1 1 0 1
+6	0 1 1 0	-2	1 1 1 0
+7	0 1 1 1	-1	1 1 1 1

dest		DEST	dest		DEST
Rn	R0L/R0	0 0 0 0	dsp:8[An]	dsp:8[A0]	1 0 0 0
	R0H/R1	0 0 0 1		dsp:8[A1]	1 0 0 1
	R1L/R2	0 0 1 0	dsp:8[SB/FB]	dsp:8[SB]	1 0 1 0
	R1H/R3	0 0 1 1		dsp:8[FB]	1 0 1 1
An	A0	0 1 0 0	dsp:16[An]	dsp:16[A0]	1 1 0 0
	A1	0 1 0 1		dsp:16[A1]	1 1 0 1
[An]	[A0]	0 1 1 0	dsp:16[SB]	dsp:16[SB]	1 1 1 0
	[A1]	0 1 1 1	abs16	abs16	1 1 1 1

**[ Number of Bytes/Number of Cycles ]**

dest	Rn	An	[An]	dsp:8[An]	dsp:8[SB/FB]	dsp:16[An]	dsp:16[SB]	abs16
Bytes/Cycles	2/1	2/1	2/3	3/3	3/3	4/3	4/3	4/3

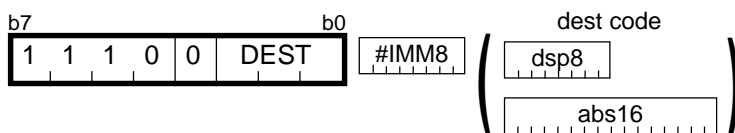
**CMP****(3) CMP.B:S #IMM8, dest**

dest		DEST
Rn	R0H	0 1 1
	R0L	1 0 0
dsp:8[SB/FB]	dsp:8[SB]	1 0 1
	dsp:8[FB]	1 1 0
abs16	abs16	1 1 1

**[ Number of Bytes/Number of Cycles ]**

dest	Rn	dsp:8[SB/FB]	abs16
Bytes/Cycles	2/1	3/3	4/3

## CMP

(4) **CMP.size:G** src, dest

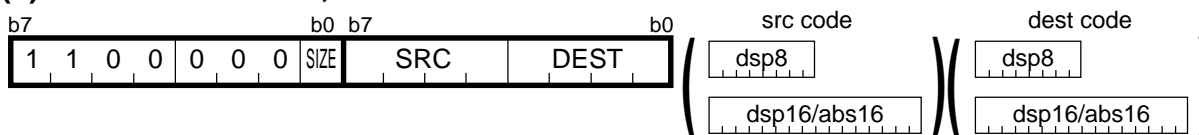

.size	SIZE
.B	0
.W	1

src/dest		SRC/DEST	src/dest		SRC/DEST
Rn	R0L/R0	0 0 0 0	dsp:8[An]	dsp:8[A0]	1 0 0 0
	R0H/R1	0 0 0 1		dsp:8[A1]	1 0 0 1
	R1L/R2	0 0 1 0	dsp:8[SB/FB]	dsp:8[SB]	1 0 1 0
	R1H/R3	0 0 1 1		dsp:8[FB]	1 0 1 1
An	A0	0 1 0 0	dsp:16[An]	dsp:16[A0]	1 1 0 0
	A1	0 1 0 1		dsp:16[A1]	1 1 0 1
[An]	[A0]	0 1 1 0	dsp:16[SB]	dsp:16[SB]	1 1 1 0
	[A1]	0 1 1 1	abs16	abs16	1 1 1 1

[ Number of Bytes/Number of Cycles ]

src \ dest	Rn	An	[An]	dsp:8[An]	dsp:8[SB/FB]	dsp:16[An]	dsp:16[SB]	abs16
Rn	2/2	2/2	2/3	3/3	3/3	4/3	4/3	4/3
An	2/2	2/2	2/3	3/3	3/3	4/3	4/3	4/3
[An]	2/3	2/3	2/4	3/4	3/4	4/4	4/4	4/4
dsp:8[An]	3/3	3/3	3/4	4/4	4/4	5/4	5/4	5/4
dsp:8[SB/FB]	3/3	3/3	3/4	4/4	4/4	5/4	5/4	5/4
dsp:16[An]	4/3	4/3	4/4	5/4	5/4	6/4	6/4	6/4
dsp:16[SB]	4/3	4/3	4/4	5/4	5/4	6/4	6/4	6/4
abs16	4/3	4/3	4/4	5/4	5/4	6/4	6/4	6/4

## CMP

### (5) CMP.B:S src, R0L/R0H

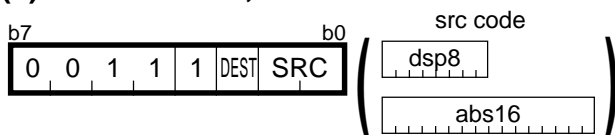

src		SRC
Rn	R0L/R0H	0 0
dsp:8[SB/FB]	dsp:8[SB]	0 1
	dsp:8[FB]	1 0
abs16	abs16	1 1

dest	DEST
R0L	0
R0H	1

#### [ Number of Bytes/Number of Cycles ]

src	Rn	dsp:8[SB/FB]	abs16
Bytes/Cycles	1/2	2/3	3/3

## DADC

### (1) DADC.B #IMM8, R0L

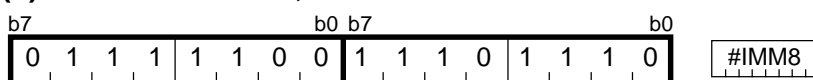

#### [ Number of Bytes/Number of Cycles ]

Bytes/Cycles	3/5
--------------	-----

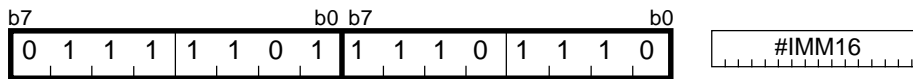
**DADC****(2) DADC.W #IMM16, R0**

[ Number of Bytes/Number of Cycles ]

Bytes/Cycles	4/5
--------------	-----

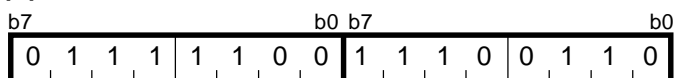
**DADC****(3) DADC.B R0H, R0L**

[ Number of Bytes/Number of Cycles ]

Bytes/Cycles	2/5
--------------	-----

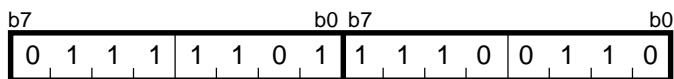
**DADC****(4) DADC.W R1, R0**

[ Number of Bytes/Number of Cycles ]

Bytes/Cycles	2/5
--------------	-----

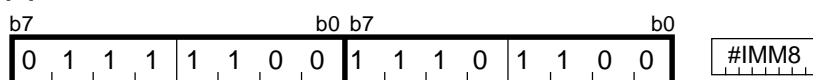
**DADD****(1) DADD.B #IMM8, R0L**

[ Number of Bytes/Number of Cycles ]

Bytes/Cycles	3/5
--------------	-----

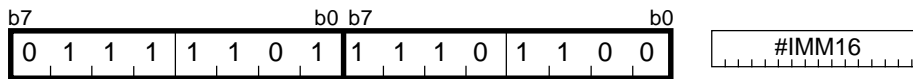
**DADD****(2) DADD.W #IMM16, R0**

[ Number of Bytes/Number of Cycles ]

Bytes/Cycles	4/5
--------------	-----

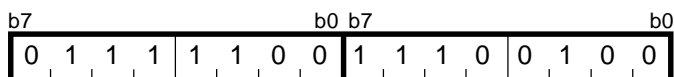
**DADD****(3) DADD.B R0H, R0L**

[ Number of Bytes/Number of Cycles ]

Bytes/Cycles	2/5
--------------	-----

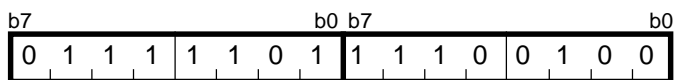
**DADD****(4) DADD.W R1, R0**

[ Number of Bytes/Number of Cycles ]

Bytes/Cycles	2/5
--------------	-----

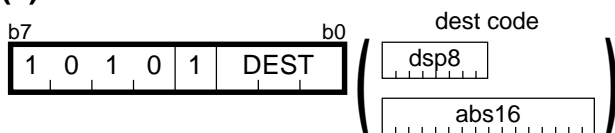
**DEC****(1) DEC.B dest**

dest		DEST
Rn	R0H	0 1 1
	R0L	1 0 0
dsp:8[SB/FB]	dsp:8[SB]	1 0 1
	dsp:8[FB]	1 1 0
abs16	abs16	1 1 1

[ Number of Bytes/Number of Cycles ]

dest	Rn	dsp:8[SB/FB]	abs16
Bytes/Cycles	1/1	2/3	3/3

## DEC

(2) DEC.W dest



dest	DEST
A0	0
A1	1

[ Number of Bytes/Number of Cycles ]

Bytes/Cycles	1/1
--------------	-----

## DIV

(1) DIV.size #IMM

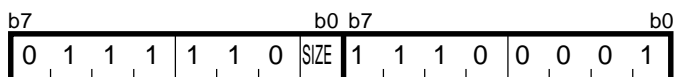

#IMM8

#IMM16

.size	SIZE
.B	0
.W	1

[ Number of Bytes/Number of Cycles ]

Bytes/Cycles	3/22
--------------	------

- If the size specifier (.size) is (.W), the number of bytes and cycles indicated are increased by 1 and 6, respectively.
- The number of cycles may decrease if an overflow occurs or depending on the value of the divisor or dividend.

# DIV

## (2) DIV.size src

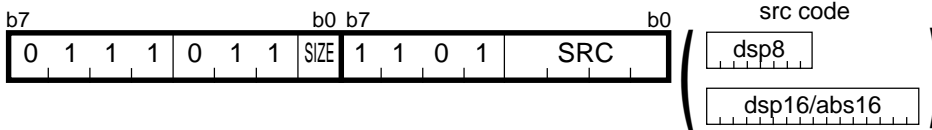

.size	SIZE
.B	0
.W	1

src		SRC	src		SRC
Rn	R0L/R0	0 0 0 0	dsp:8[An]	dsp:8[A0]	1 0 0 0
	R0H/R1	0 0 0 1		dsp:8[A1]	1 0 0 1
	R1L/R2	0 0 1 0	dsp:8[SB/FB]	dsp:8[SB]	1 0 1 0
	R1H/R3	0 0 1 1		dsp:8[FB]	1 0 1 1
An	A0	0 1 0 0	dsp:16[An]	dsp:16[A0]	1 1 0 0
	A1	0 1 0 1		dsp:16[A1]	1 1 0 1
[An]	[A0]	0 1 1 0	dsp:16[SB]	dsp:16[SB]	1 1 1 0
	[A1]	0 1 1 1	abs16	abs16	1 1 1 1

### [ Number of Bytes/Number of Cycles ]

src	Rn	An	[An]	dsp:8[An]	dsp:8[SB/FB]	dsp:16[An]	dsp:16[SB]	abs16
Bytes/Cycles	2/22	2/22	2/24	3/24	3/24	4/24	4/24	4/24

- If the size specifier (.size) is (.W), the number of cycles indicated is increased by 6.
- The number of cycles may decrease if an overflow occurs or depending on the value of the divisor or dividend.

# DIVU

## (1) DIVU.size #IMM

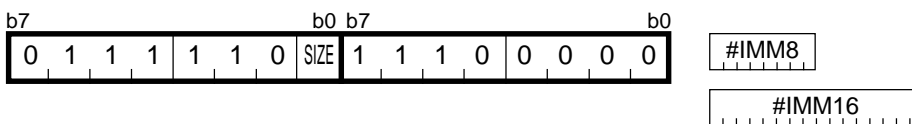

.size	SIZE
.B	0
.W	1

### [ Number of Bytes/Number of Cycles ]

Bytes/Cycles	3/18
--------------	------

- The number of cycles may decrease if an overflow occurs or depending on the value of the divisor or dividend.
- If the size specifier (.size) is (.W), the number of bytes and cycles indicated are increased by 1 and 7, respectively.

# DIVU

## (2) DIVU.size src

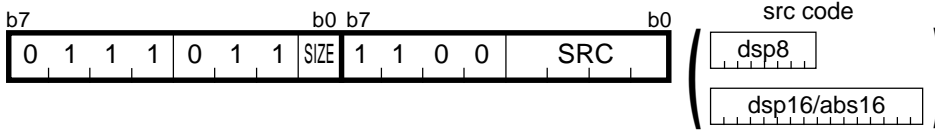

.size	SIZE
.B	0
.W	1

		src	SRC			src	SRC
Rn	R0L/R0		0 0 0 0	dsp:8[An]	dsp:8[A0]		1 0 0 0
	R0H/R1		0 0 0 1		dsp:8[A1]		1 0 0 1
	R1L/R2		0 0 1 0	dsp:8[SB/FB]	dsp:8[SB]		1 0 1 0
	R1H/R3		0 0 1 1		dsp:8[FB]		1 0 1 1
An	A0		0 1 0 0	dsp:16[An]	dsp:16[A0]		1 1 0 0
	A1		0 1 0 1		dsp:16[A1]		1 1 0 1
[An]	[A0]		0 1 1 0	dsp:16[SB]		dsp:16[SB]	1 1 1 0
	[A1]		0 1 1 1	abs16		abs16	1 1 1 1

### [ Number of Bytes/Number of Cycles ]

src	Rn	An	[An]	dsp:8[An]	dsp:8[SB/FB]	dsp:16[An]	dsp:16[SB]	abs16
Bytes/Cycles	2/18	2/18	2/20	3/20	3/20	4/20	4/20	4/20

- If the size specifier (.size) is (.W), the number of cycles indicated is increased by 7.
- The number of cycles may decrease if an overflow occurs or depending on the value of the divisor or dividend.

# DIVX

## (1) DIVX.size #IMM

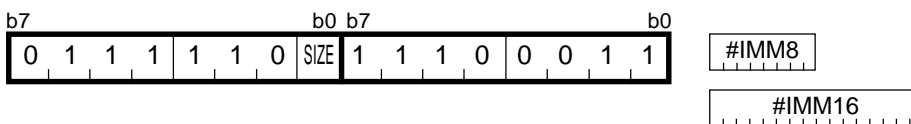

.size	SIZE
.B	0
.W	1

### [ Number of Bytes/Number of Cycles ]

Bytes/Cycles	3/22
--------------	------

- The number of cycles may decrease if an overflow occurs or depending on the value of the divisor or dividend.
- If the size specifier (.size) is (.W), the number of bytes and cycles indicated are increased by 1 and 6, respectively.

# DIVX

## (2) DIVX.size src

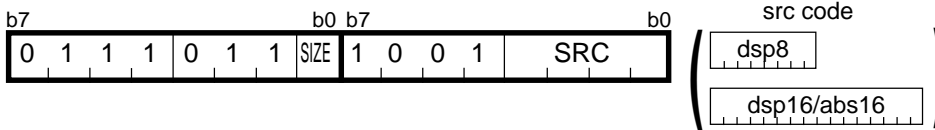

.size	SIZE
.B	0
.W	1

src		SRC	src		SRC
Rn	R0L/R0	0 0 0 0	dsp:8[An]	dsp:8[A0]	1 0 0 0
	R0H/R1	0 0 0 1		dsp:8[A1]	1 0 0 1
	R1L/R2	0 0 1 0	dsp:8[SB/FB]	dsp:8[SB]	1 0 1 0
	R1H/R3	0 0 1 1		dsp:8[FB]	1 0 1 1
An	A0	0 1 0 0	dsp:16[An]	dsp:16[A0]	1 1 0 0
	A1	0 1 0 1		dsp:16[A1]	1 1 0 1
[An]	[A0]	0 1 1 0	dsp:16[SB]	dsp:16[SB]	1 1 1 0
	[A1]	0 1 1 1	abs16	abs16	1 1 1 1

### [ Number of Bytes/Number of Cycles ]

src	Rn	An	[An]	dsp:8[An]	dsp:8[SB/FB]	dsp:16[An]	dsp:16[SB]	abs16
Bytes/Cycles	2/22	2/22	2/24	3/24	3/24	4/24	4/24	4/24

- If the size specifier (.size) is (.W), the number of cycles indicated is increased by 6.
- The number of cycles may decrease if an overflow occurs or depending on the value of the divisor or dividend.

# DSBB

## (1) DSBB.B #IMM8, R0L

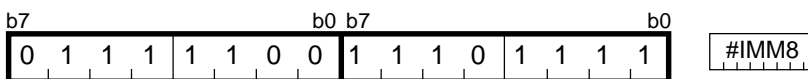

### [ Number of Bytes/Number of Cycles ]

Bytes/Cycles	3/4
--------------	-----

## DSBB

(2) DSBB.W #IMM16, R0

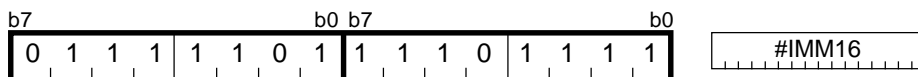

[ Number of Bytes/Number of Cycles ]

Bytes/Cycles	4/4
--------------	-----

## DSBB

(3) DSBB.B R0H, R0L

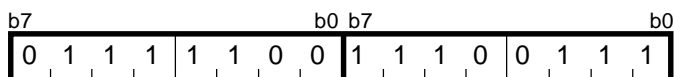

[ Number of Bytes/Number of Cycles ]

Bytes/Cycles	2/4
--------------	-----

## DSBB

### (4) DSBB.W R1, R0

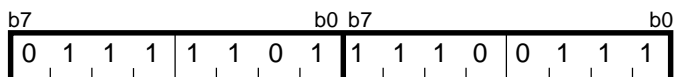

[ Number of Bytes/Number of Cycles ]

Bytes/Cycles	2/4
--------------	-----

## DSUB

### (1) DSUB.B #IMM8, R0L

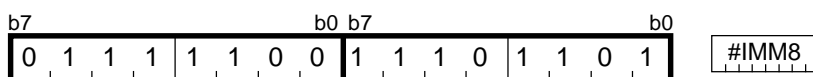

[ Number of Bytes/Number of Cycles ]

Bytes/Cycles	3/4
--------------	-----

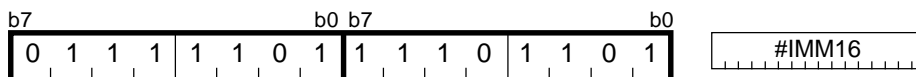
**DSUB****(2) DSUB.W #IMM16, R0**

[ Number of Bytes/Number of Cycles ]

Bytes/Cycles	4/4
--------------	-----

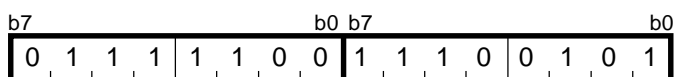
**DSUB****(3) DSUB.B R0H, R0L**

[ Number of Bytes/Number of Cycles ]

Bytes/Cycles	2/4
--------------	-----

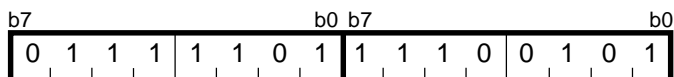
**DSUB****(4) DSUB.W R1, R0**

[ Number of Bytes/Number of Cycles ]

Bytes/Cycles	2/4
--------------	-----

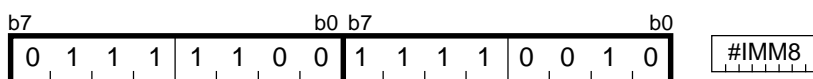
**ENTER****(1) ENTER #IMM8**

[ Number of Bytes/Number of Cycles ]

Bytes/Cycles	3/4
--------------	-----

# EXITD

## (1) EXITD

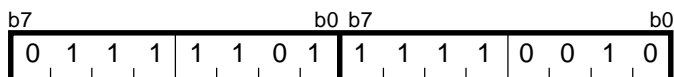

[ Number of Bytes/Number of Cycles ]

Bytes/Cycles	2/9
--------------	-----

# EXTS

## (1) EXTS.B dest

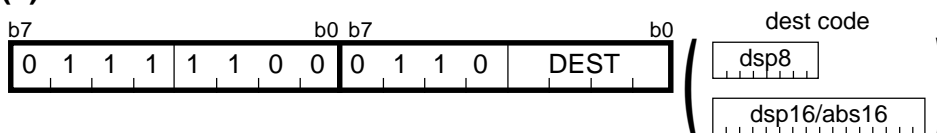

dest		DEST	dest		DEST
Rn	R0L	0 0 0 0	dsp:8[An]	dsp:8[A0]	1 0 0 0
	---	0 0 0 1		dsp:8[A1]	1 0 0 1
	R1L	0 0 1 0	dsp:8[SB/FB]	dsp:8[SB]	1 0 1 0
	---	0 0 1 1		dsp:8[FB]	1 0 1 1
---	---	0 1 0 0	dsp:16[An]	dsp:16[A0]	1 1 0 0
	---	0 1 0 1		dsp:16[A1]	1 1 0 1
[An]	[A0]	0 1 1 0	dsp:16[SB]	dsp:16[SB]	1 1 1 0
	[A1]	0 1 1 1	abs16	abs16	1 1 1 1

- Items marked --- cannot be selected.

[ Number of Bytes/Number of Cycles ]

dest	Rn	[An]	dsp:8[An]	dsp:8[SB/FB]	dsp:16[An]	dsp:16[SB]	abs16
Bytes/Cycles	2/3	2/5	3/5	3/5	4/5	4/5	4/5

## EXTS

### (2) EXTS.W R0

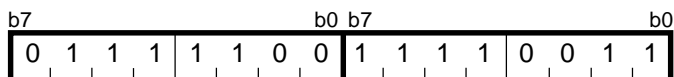

[ Number of Bytes/Number of Cycles ]

Bytes/Cycles	2/3
--------------	-----

## FCLR

### (1) FCLR dest

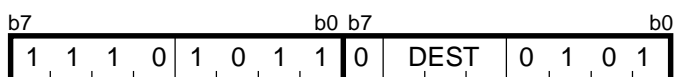

dest	DEST
C	0 0 0
D	0 0 1
Z	0 1 0
S	0 1 1
B	1 0 0
O	1 0 1
I	1 1 0
U	1 1 1

[ Number of Bytes/Number of Cycles ]

Bytes/Cycles	2/2
--------------	-----

# FSET

(1) FSET dest

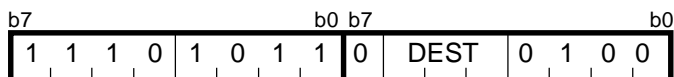

dest	DEST
C	0 0 0
D	0 0 1
Z	0 1 0
S	0 1 1
B	1 0 0
O	1 0 1
I	1 1 0
U	1 1 1

[ Number of Bytes/Number of Cycles ]

Bytes/Cycles	2/2
--------------	-----

# INC

(1) INC.B dest

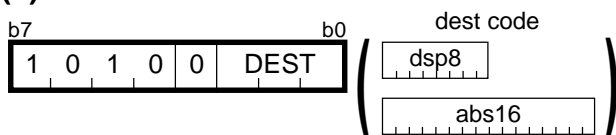

dest		DEST
Rn	R0H	0 1 1
	R0L	1 0 0
dsp:8[SB/FB]	dsp:8[SB]	1 0 1
	dsp:8[FB]	1 1 0
abs16	abs16	1 1 1

[ Number of Bytes/Number of Cycles ]

dest	Rn	dsp:8[SB/FB]	abs16
Bytes/Cycles	1/1	2/3	3/3

# INC

## (2) INC.W dest



dest	DEST
A0	0
A1	1

[ Number of Bytes/Number of Cycles ]

Bytes/Cycles	1/1
--------------	-----

# INT

## (1) INT #IMM

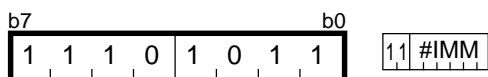

[ Number of Bytes/Number of Cycles ]

Bytes/Cycles	2/19
--------------	------

# INTO

## (1) INTO

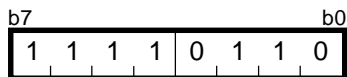

### [ Number of Bytes/Number of Cycles ]

Bytes/Cycles	1/1
--------------	-----

- If the O flag = 1, the number of cycles indicated is increased by 19.

# JCnd

## (1) JCnd label

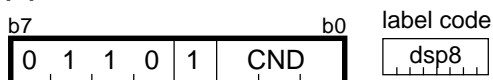

dsp8 = address indicated by label – (start address of instruction + 1)

<i>Cnd</i>	CND	<i>Cnd</i>	CND
GEU/C	0 0 0	LTU/NC	1 0 0
GTU	0 0 1	LEU	1 0 1
EQ/Z	0 1 0	NE/NZ	1 1 0
N	0 1 1	PZ	1 1 1

### [ Number of Bytes/Number of Cycles ]

Bytes/Cycles	2/2
--------------	-----

- If the program branches to a label, the number of cycles indicated is increased by 2.

## JCnd

### (2) JCnd label

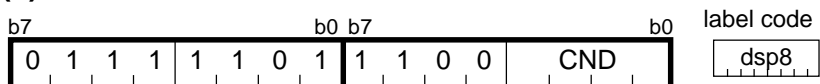

dsp8 = address indicated by label – (start address of instruction + 2)

<i>Cnd</i>	CND	<i>Cnd</i>	CND
LE	1 0 0 0	GT	1 1 0 0
O	1 0 0 1	NO	1 1 0 1
GE	1 0 1 0	LT	1 1 1 0

#### [ Number of Bytes/Number of Cycles ]

Bytes/Cycles	3/2
--------------	-----

- If the program branches to a label, the number of cycles indicated is increased by 2.

## JMP

### (1) JMP.S label

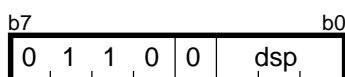

dsp = address indicated by label – (start address of instruction + 2)

#### [ Number of Bytes/Number of Cycles ]

Bytes/Cycles	1/5
--------------	-----

## JMP

### (2) JMP.B label

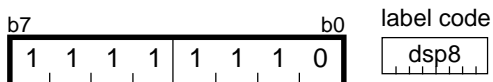

dsp8 = address indicated by label – (start address of instruction + 1)

[ Number of Bytes/Number of Cycles ]

Bytes/Cycles	2/4
--------------	-----

## JMP

### (3) JMP.W label

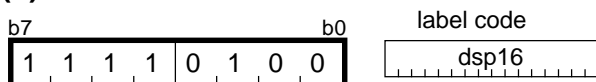

dsp16 = address indicated by label – (start address of instruction + 1)

[ Number of Bytes/Number of Cycles ]

Bytes/Cycles	3/4
--------------	-----

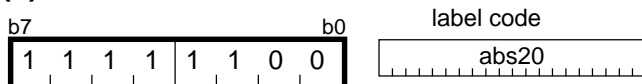
**JMP****(4) JMP.A label**

[ Number of Bytes/Number of Cycles ]

Bytes/Cycles	4/4
--------------	-----

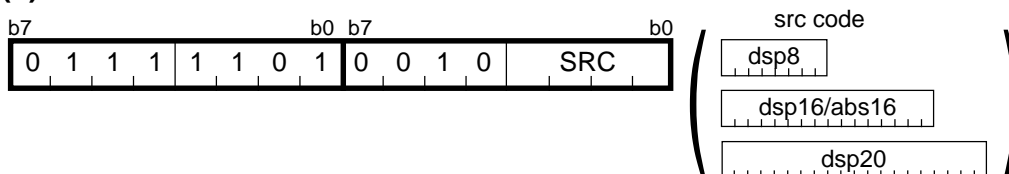
**JMPI****(1) JMPI.W src**

src		SRC	src		SRC
Rn	R0	0 0 0 0	dsp:8[An]	dsp:8[A0]	1 0 0 0
	R1	0 0 0 1		dsp:8[A1]	1 0 0 1
	R2	0 0 1 0	dsp:8[SB/FB]	dsp:8[SB]	1 0 1 0
	R3	0 0 1 1		dsp:8[FB]	1 0 1 1
An	A0	0 1 0 0	dsp:20[An]	dsp:20[A0]	1 1 0 0
	A1	0 1 0 1		dsp:20[A1]	1 1 0 1
[An]	[A0]	0 1 1 0	dsp:16[SB]	dsp:16[SB]	1 1 1 0
	[A1]	0 1 1 1	abs16	abs16	1 1 1 1

[ Number of Bytes/Number of Cycles ]

src	Rn	An	[An]	dsp:8[An]	dsp:8[SB/FB]	dsp:20[An]	dsp:16[SB]	abs16
Bytes/Cycles	2/7	2/7	2/11	3/11	3/11	5/11	4/11	4/11

## JMPI

### (2) JMPL.A src

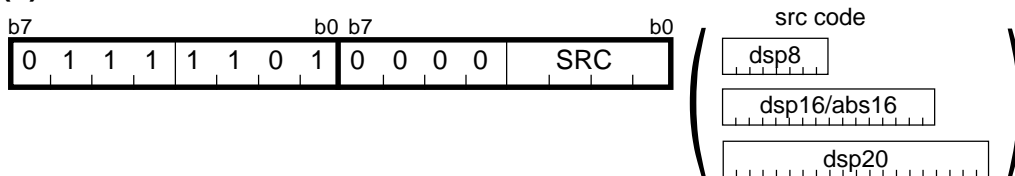

src		SRC	src		SRC	
Rn	R2R0	0 0 0 0	dsp:8[An]	dsp:8[A0]	1 0 0 0	
	R3R1	0 0 0 1		dsp:8[A1]	1 0 0 1	
	---	0 0 1 0		dsp:8[SB/FB]	dsp:8[SB]	1 0 1 0
	---	0 0 1 1			dsp:8[FB]	1 0 1 1
An	A1A0	0 1 0 0	dsp:20[An]	dsp:20[A0]	1 1 0 0	
	---	0 1 0 1		dsp:20[A1]	1 1 0 1	
[An]	[A0]	0 1 1 0	dsp:16[SB]	dsp:16[SB]	1 1 1 0	
	[A1]	0 1 1 1	abs16	abs16	1 1 1 1	

- Items marked --- cannot be selected.

#### [ Number of Bytes/Number of Cycles ]

src	Rn	An	[An]	dsp:8[An]	dsp:8[SB/FB]	dsp:20[An]	dsp:16[SB]	abs16
Bytes/Cycles	2/6	2/6	2/10	3/10	3/10	5/10	4/10	4/10

# JSR

## (1) JSR.W label

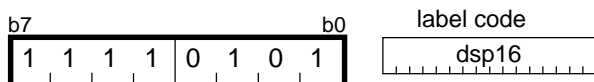

dsp16 = address indicated by label – (start address of instruction + 1)

[ Number of Bytes/Number of Cycles ]

Bytes/Cycles	3/8
--------------	-----

# JSR

## (2) JSR.A label

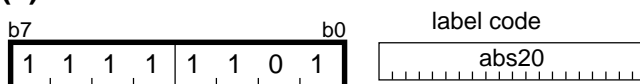

[ Number of Bytes/Number of Cycles ]

Bytes/Cycles	4/9
--------------	-----

# JSRI

## (1) JSRI.W src

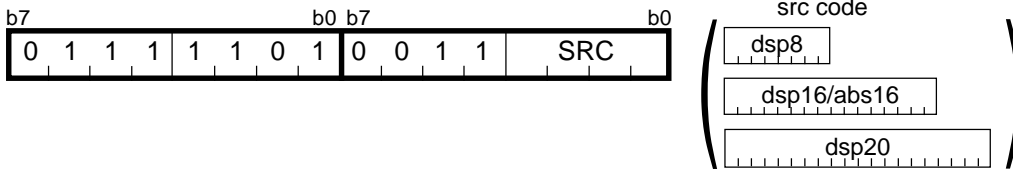

src		SRC	src		SRC	
Rn	R0	0 0 0 0	dsp:8[An]	dsp:8[A0]	1 0 0 0	
	R1	0 0 0 1		dsp:8[A1]	1 0 0 1	
	R2	0 0 1 0		dsp:8[SB/FB]	dsp:8[SB]	1 0 1 0
	R3	0 0 1 1			dsp:8[FB]	1 0 1 1
An	A0	0 1 0 0	dsp:20[An]	dsp:20[A0]	1 1 0 0	
	A1	0 1 0 1		dsp:20[A1]	1 1 0 1	
[An]	[A0]	0 1 1 0	dsp:16[SB]	dsp:16[SB]	1 1 1 0	
	[A1]	0 1 1 1	abs16	abs16	1 1 1 1	

### [ Number of Bytes/Number of Cycles ]

src	Rn	An	[An]	dsp:8[An]	dsp:8[SB/FB]	dsp:20[An]	dsp:16[SB]	abs16
Bytes/Cycles	2/11	2/11	2/15	3/15	3/15	5/15	4/15	4/15

# JSRI

## (2) JSRI.A src

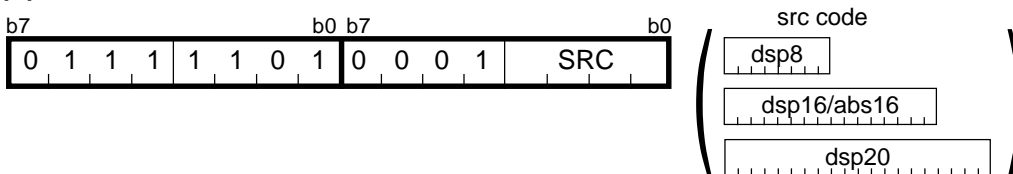

src		SRC	src		SRC	
Rn	R2R0	0 0 0 0	dsp:8[An]	dsp:8[A0]	1 0 0 0	
	R3R1	0 0 0 1		dsp:8[A1]	1 0 0 1	
	---	0 0 1 0		dsp:8[SB/FB]	dsp:8[SB]	1 0 1 0
	---	0 0 1 1			dsp:8[FB]	1 0 1 1
An	A1A0	0 1 0 0	dsp:20[An]	dsp:20[A0]	1 1 0 0	
	---	0 1 0 1		dsp:20[A1]	1 1 0 1	
[An]	[A0]	0 1 1 0	dsp:16[SB]	dsp:16[SB]	1 1 1 0	
	[A1]	0 1 1 1	abs16	abs16	1 1 1 1	

- Items marked --- cannot be selected.

### [ Number of Bytes/Number of Cycles ]

src	Rn	An	[An]	dsp:8[An]	dsp:8[SB/FB]	dsp:20[An]	dsp:16[SB]	abs16
Bytes/Cycles	2/11	2/11	2/15	3/15	3/15	5/15	4/15	4/15

# LDC

## (1) LDC #IMM16, dest



dest	DEST
---	0 0 0
INTBL	0 0 1
INTBH	0 1 0
FLG	0 1 1
ISP	1 0 0
SP	1 0 1
SB	1 1 0
FB	1 1 1

- Items marked --- cannot be selected.

### [ Number of Bytes/Number of Cycles ]

Bytes/Cycles	4/2
--------------	-----

# LDC

## (2) LDC src, dest



src		SRC	src		SRC	dest		DEST
Rn	R0	0 0 0 0	dsp:8[An]	dsp:8[A0]	1 0 0 0	---	0 0 0	
	R1	0 0 0 1		dsp:8[A1]	1 0 0 1	INTBL	0 0 1	
	R2	0 0 1 0		dsp:8[SB/FB]	dsp:8[SB]	1 0 1 0	INTBH	0 1 0
	R3	0 0 1 1			dsp:8[FB]	1 0 1 1	FLG	0 1 1
An	A0	0 1 0 0	dsp:16[An]	dsp:16[A0]	1 1 0 0	ISP	1 0 0	
	A1	0 1 0 1		dsp:16[A1]	1 1 0 1	SP	1 0 1	
[An]	[A0]	0 1 1 0	dsp:16[SB]	dsp:16[SB]	1 1 1 0	SB	1 1 0	
	[A1]	0 1 1 1	abs16	abs16	1 1 1 1	FB	1 1 1	

- Items marked --- cannot be selected.

### [ Number of Bytes/Number of Cycles ]

src	Rn	An	[An]	dsp:8[An]	dsp:8[SB/FB]	dsp:16[An]	dsp:16[SB]	abs16
Bytes/Cycles	2/1	2/1	2/3	3/3	3/3	4/3	4/3	4/3

# LDCTX

(1) LDCTX **abs16, abs20**

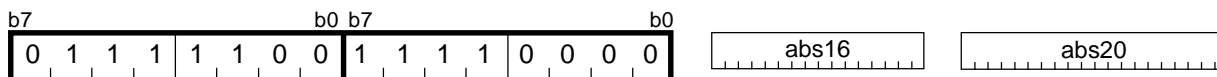

[ Number of Bytes/Number of Cycles ]

Bytes/Cycles	$7/11+2 \times m$
--------------	-------------------

- m denotes the number of transfers to be performed.

# LDE

## (1) LDE.size abs20, dest

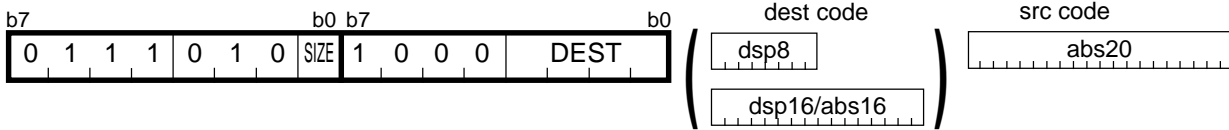

.size	SIZE
.B	0
.W	1

dest		DEST	dest		DEST	
Rn	R0L/R0	0 0 0 0	dsp:8[An]	dsp:8[A0]	1 0 0 0	
	R0H/R1	0 0 0 1		dsp:8[A1]	1 0 0 1	
	R1L/R2	0 0 1 0		dsp:8[SB/FB]	dsp:8[SB]	1 0 1 0
	R1H/R3	0 0 1 1			dsp:8[FB]	1 0 1 1
An	A0	0 1 0 0	dsp:16[An]	dsp:16[A0]	1 1 0 0	
	A1	0 1 0 1		dsp:16[A1]	1 1 0 1	
[An]	[A0]	0 1 1 0	dsp:16[SB]	dsp:16[SB]	1 1 1 0	
	[A1]	0 1 1 1	abs16	abs16	1 1 1 1	

### [ Number of Bytes/Number of Cycles ]

dest	Rn	An	[An]	dsp:8[An]	dsp:8[SB/FB]	dsp:16[An]	dsp:16[SB]	abs16
Bytes/Cycles	5/4	5/4	5/5	6/5	6/5	7/5	7/5	7/5

# LDE

## (2) LDE.size dsp:20[A0], dest

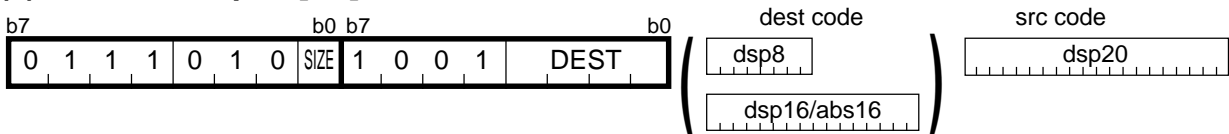

.size	SIZE
.B	0
.W	1

dest		DEST	dest		DEST	
Rn	R0L/R0	0 0 0 0	dsp:8[An]	dsp:8[A0]	1 0 0 0	
	R0H/R1	0 0 0 1		dsp:8[A1]	1 0 0 1	
	R1L/R2	0 0 1 0		dsp:8[SB/FB]	dsp:8[SB]	1 0 1 0
	R1H/R3	0 0 1 1			dsp:8[FB]	1 0 1 1
An	A0	0 1 0 0	dsp:16[An]	dsp:16[A0]	1 1 0 0	
	A1	0 1 0 1		dsp:16[A1]	1 1 0 1	
[An]	[A0]	0 1 1 0	dsp:16[SB]	dsp:16[SB]	1 1 1 0	
	[A1]	0 1 1 1	abs16	abs16	1 1 1 1	

### [ Number of Bytes/Number of Cycles ]

dest	Rn	An	[An]	dsp:8[An]	dsp:8[SB/FB]	dsp:16[An]	dsp:16[SB]	abs16
Bytes/Cycles	5/4	5/4	5/5	6/5	6/5	7/5	7/5	7/5

## LDE

### (3) LDE.size [A1A0], dest

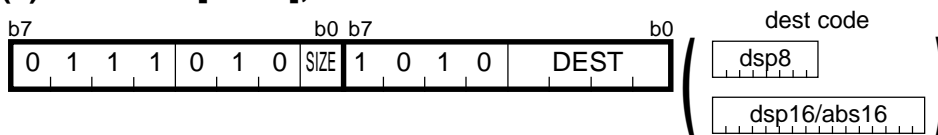

.size	SIZE
.B	0
.W	1

dest		DEST	dest		DEST
Rn	R0L/R0	0 0 0 0	dsp:8[An]	dsp:8[A0]	1 0 0 0
	R0H/R1	0 0 0 1		dsp:8[A1]	1 0 0 1
	R1L/R2	0 0 1 0	dsp:8[SB/FB]	dsp:8[SB]	1 0 1 0
	R1H/R3	0 0 1 1		dsp:8[FB]	1 0 1 1
An	A0	0 1 0 0	dsp:16[An]	dsp:16[A0]	1 1 0 0
	A1	0 1 0 1		dsp:16[A1]	1 1 0 1
[An]	[A0]	0 1 1 0	dsp:16[SB]	dsp:16[SB]	1 1 1 0
	[A1]	0 1 1 1	abs16	abs16	1 1 1 1

#### [ Number of Bytes/Number of Cycles ]

dest	Rn	An	[An]	dsp:8[An]	dsp:8[SB/FB]	dsp:16[An]	dsp:16[SB]	abs16
Bytes/Cycles	2/4	2/4	2/5	3/5	3/5	4/5	4/5	4/5

## LDINTB

### (1) LDINTB #IMM

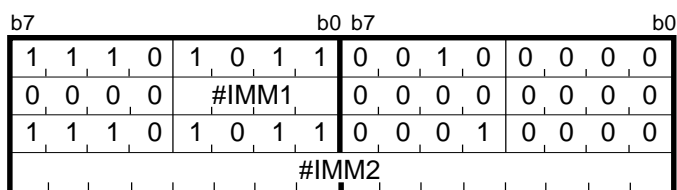

- #IMM1 indicates the 4 high-order bits of #IMM.
- #IMM2 indicates the 16 low-order bits of #IMM.

#### [ Number of Bytes/Number of Cycles ]

Bytes/Cycles	8/4
--------------	-----

# LDIPL

**(1) LDIPL #IMM**

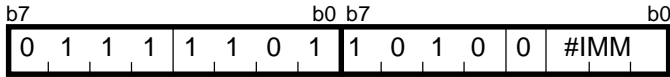

[ Number of Bytes/Number of Cycles ]

Bytes/Cycles	2/2
--------------	-----

# MOV

**(1) MOV.size:G #IMM, dest**

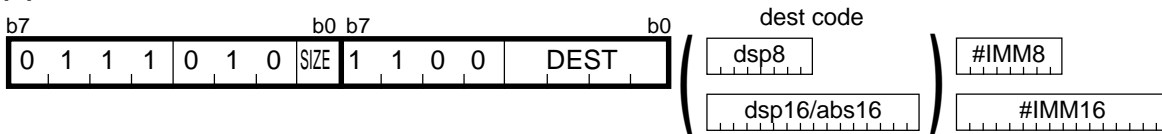

.size	SIZE
.B	0
.W	1

dest		DEST	dest		DEST	
Rn	R0L/R0	0 0 0 0	dsp:8[An]	dsp:8[A0]	1 0 0 0	
	R0H/R1	0 0 0 1		dsp:8[A1]	1 0 0 1	
	R1L/R2	0 0 1 0		dsp:8[SB/FB]	dsp:8[SB]	1 0 1 0
	R1H/R3	0 0 1 1			dsp:8[FB]	1 0 1 1
An	A0	0 1 0 0	dsp:16[An]	dsp:16[A0]	1 1 0 0	
	A1	0 1 0 1		dsp:16[A1]	1 1 0 1	
[An]	[A0]	0 1 1 0	dsp:16[SB]	dsp:16[SB]	1 1 1 0	
	[A1]	0 1 1 1	abs16	abs16	1 1 1 1	

[ Number of Bytes/Number of Cycles ]

dest	Rn	An	[An]	dsp:8[An]	dsp:8[SB/FB]	dsp:16[An]	dsp:16[SB]	abs16
Bytes/Cycles	3/2	3/2	3/3	4/3	4/3	5/3	5/3	5/3

- If the size specifier (.size) is (.W), the number of bytes indicated is increased by 1.

# MOV

(2) MOV.size:Q #IMM, dest

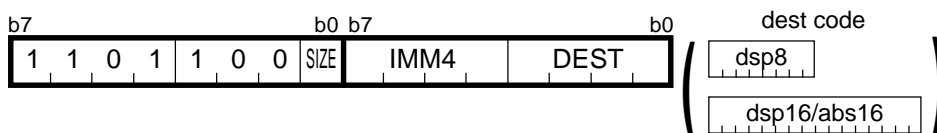

.size	SIZE
.B	0
.W	1

#IMM	IMM4	#IMM	IMM4
0	0 0 0 0	-8	1 0 0 0
+1	0 0 0 1	-7	1 0 0 1
+2	0 0 1 0	-6	1 0 1 0
+3	0 0 1 1	-5	1 0 1 1
+4	0 1 0 0	-4	1 1 0 0
+5	0 1 0 1	-3	1 1 0 1
+6	0 1 1 0	-2	1 1 1 0
+7	0 1 1 1	-1	1 1 1 1

dest		DEST	dest		DEST
Rn	R0L/R0	0 0 0 0	dsp:8[An]	dsp:8[A0]	1 0 0 0
	R0H/R1	0 0 0 1		dsp:8[A1]	1 0 0 1
	R1L/R2	0 0 1 0	dsp:8[SB/FB]	dsp:8[SB]	1 0 1 0
	R1H/R3	0 0 1 1		dsp:8[FB]	1 0 1 1
An	A0	0 1 0 0	dsp:16[An]	dsp:16[A0]	1 1 0 0
	A1	0 1 0 1		dsp:16[A1]	1 1 0 1
[An]	[A0]	0 1 1 0	dsp:16[SB]	dsp:16[SB]	1 1 1 0
	[A1]	0 1 1 1	abs16	abs16	1 1 1 1

[ Number of Bytes/Number of Cycles ]

dest	Rn	An	[An]	dsp:8[An]	dsp:8[SB/FB]	dsp:16[An]	dsp:16[SB]	abs16
Bytes/Cycles	2/1	2/1	2/2	3/2	3/2	4/2	4/2	4/2

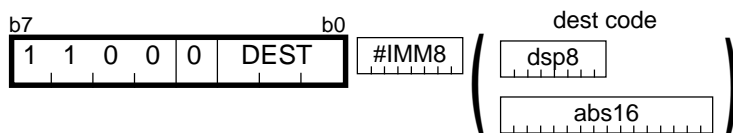
**MOV****(3) MOV.B:S #IMM8, dest**

dest		DEST
Rn	R0H	0 1 1
	R0L	1 0 0
dsp:8[SB/FB]	dsp:8[SB]	1 0 1
	dsp:8[FB]	1 1 0
abs16	abs16	1 1 1

**[ Number of Bytes/Number of Cycles ]**

dest	Rn	dsp:8[SB/FB]	abs16
Bytes/Cycles	2/1	3/2	4/2

## MOV

### (4) MOV.size:S #IMM, dest

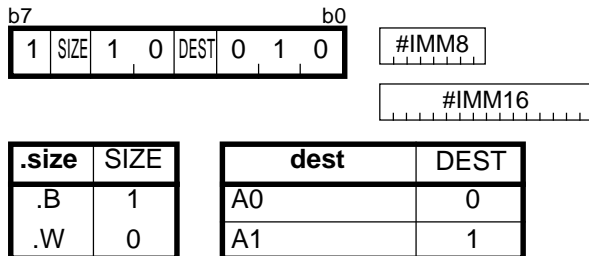

#### [ Number of Bytes/Number of Cycles ]

Bytes/Cycles	2/1
--------------	-----

- If the size specifier (.size) is (.W), the number of bytes and cycles indicated are increased by 1 each.

## MOV

### (5) MOV.B:Z #0, dest

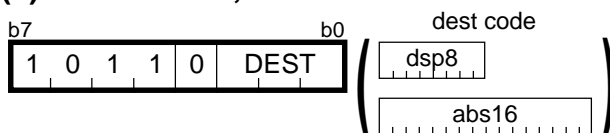

dest		DEST
Rn	R0H	0 1 1
	R0L	1 0 0
dsp:8[SB/FB]	dsp:8[SB]	1 0 1
	dsp:8[FB]	1 1 0
abs16	abs16	1 1 1

#### [ Number of Bytes/Number of Cycles ]

dest	Rn	dsp:8[SB/FB]	abs16
Bytes/Cycles	1/1	2/2	3/2

# MOV

## (6) MOV.size:G src, dest

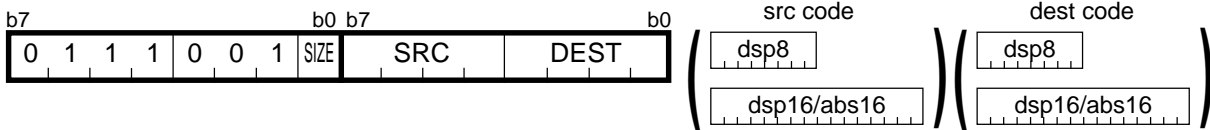

.size	SIZE
.B	0
.W	1

src/dest		SRC/DEST	src/dest		SRC/DEST
Rn	R0L/R0	0 0 0 0	dsp:8[An]	dsp:8[A0]	1 0 0 0
	R0H/R1	0 0 0 1		dsp:8[A1]	1 0 0 1
	R1L/R2	0 0 1 0	dsp:8[SB/FB]	dsp:8[SB]	1 0 1 0
	R1H/R3	0 0 1 1		dsp:8[FB]	1 0 1 1
An	A0	0 1 0 0	dsp:16[An]	dsp:16[A0]	1 1 0 0
	A1	0 1 0 1		dsp:16[A1]	1 1 0 1
[An]	[A0]	0 1 1 0	dsp:16[SB]	dsp:16[SB]	1 1 1 0
	[A1]	0 1 1 1	abs16	abs16	1 1 1 1

### [ Number of Bytes/Number of Cycles ]

src \ dest	Rn	An	[An]	dsp:8[An]	dsp:8[SB/FB]	dsp:16[An]	dsp:16[SB]	abs16
Rn	2/2	2/2	2/2	3/2	3/2	4/2	4/2	4/2
An	2/2	2/2	2/2	3/2	3/2	4/2	4/2	4/2
[An]	2/3	2/3	2/3	3/3	3/3	4/3	4/3	4/3
dsp:8[An]	3/3	3/3	3/3	4/3	4/3	5/3	5/3	5/3
dsp:8[SB/FB]	3/3	3/3	3/3	4/3	4/3	5/3	5/3	5/3
dsp:16[An]	4/3	4/3	4/3	5/3	5/3	6/3	6/3	6/3
dsp:16[SB]	4/3	4/3	4/3	5/3	5/3	6/3	6/3	6/3
abs16	4/3	4/3	4/3	5/3	5/3	6/3	6/3	6/3

# MOV

## (7) MOV.B:S src, dest

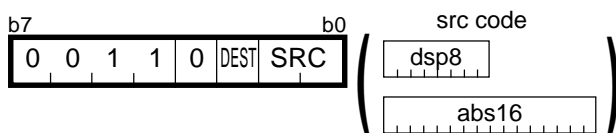

src		SRC
Rn	ROL/R0H	0 0
dsp:8[SB/FB]	dsp:8[SB]	0 1
	dsp:8[FB]	1 0
abs16	abs16	1 1

dest	DEST
A0	0
A1	1

### [ Number of Bytes/Number of Cycles ]

src	Rn	dsp:8[SB/FB]	abs16
Bytes/Cycles	1/2	2/3	3/3

# MOV

## (8) MOV.B:S ROL/R0H, dest

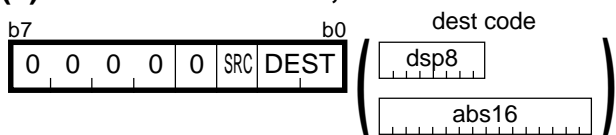

src	SRC
ROL	0
R0H	1

dest		DEST
dsp:8[SB/FB]	dsp:8[SB]	0 1
	dsp:8[FB]	1 0
abs16	abs16	1 1

### [ Number of Bytes/Number of Cycles ]

dest	dsp:8[SB/FB]	abs16
Bytes/Cycles	2/2	3/2

# MOV

## (9) MOV.B:S src, R0L/R0H

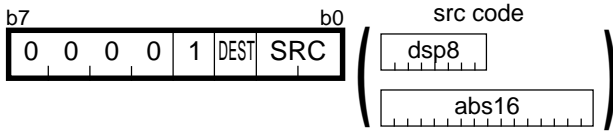

src		SRC
Rn	R0L/R0H	0 0
dsp:8[SB/FB]	dsp:8[SB]	0 1
	dsp:8[FB]	1 0
abs16	abs16	1 1

dest	DEST
R0L	0
R0H	1

### [ Number of Bytes/Number of Cycles ]

src	Rn	dsp:8[SB/FB]	abs16
Bytes/Cycles	1/2	2/3	3/3

# MOV

## (10) MOV.size:G dsp:8[SP], dest

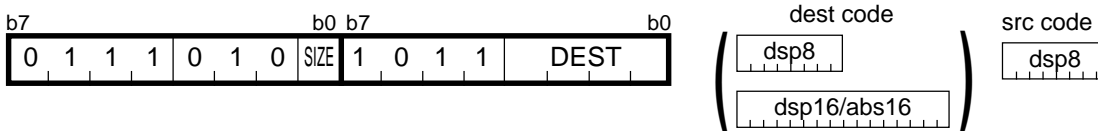

.size	SIZE
.B	0
.W	1

dest		DEST	dest		DEST	
Rn	R0L/R0	0 0 0 0	dsp:8[An]	dsp:8[A0]	1 0 0 0	
	R0H/R1	0 0 0 1		dsp:8[A1]	1 0 0 1	
	R1L/R2	0 0 1 0		dsp:8[SB/FB]	dsp:8[SB]	1 0 1 0
	R1H/R3	0 0 1 1			dsp:8[FB]	1 0 1 1
An	A0	0 1 0 0	dsp:16[An]	dsp:16[A0]	1 1 0 0	
	A1	0 1 0 1		dsp:16[A1]	1 1 0 1	
[An]	[A0]	0 1 1 0	dsp:16[SB]	dsp:16[SB]	1 1 1 0	
	[A1]	0 1 1 1	abs16	abs16	1 1 1 1	

### [ Number of Bytes/Number of Cycles ]

dest	Rn	An	[An]	dsp:8[An]	dsp:8[SB/FB]	dsp:16[An]	dsp:16[SB]	abs16
Bytes/Cycles	3/2	3/2	3/3	4/3	4/3	5/3	5/3	5/3

## MOV

### (11) MOV.size:G src, dsp:8[SP]

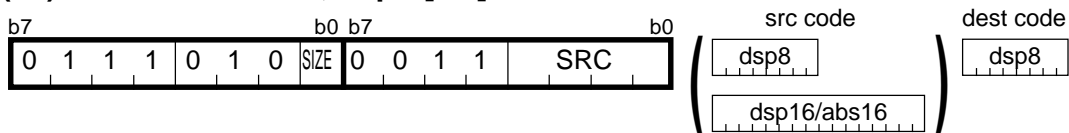

.size	SIZE
.B	0
.W	1

src		SRC	src		SRC
Rn	R0L/R0	0 0 0 0	dsp:8[An]	dsp:8[A0]	1 0 0 0
	R0H/R1	0 0 0 1		dsp:8[A1]	1 0 0 1
	R1L/R2	0 0 1 0	dsp:8[SB/FB]	dsp:8[SB]	1 0 1 0
	R1H/R3	0 0 1 1		dsp:8[FB]	1 0 1 1
An	A0	0 1 0 0	dsp:16[An]	dsp:16[A0]	1 1 0 0
	A1	0 1 0 1		dsp:16[A1]	1 1 0 1
[An]	[A0]	0 1 1 0	dsp:16[SB]	dsp:16[SB]	1 1 1 0
	[A1]	0 1 1 1	abs16	abs16	1 1 1 1

#### [ Number of Bytes/Number of Cycles ]

dest	Rn	An	[An]	dsp:8[An]	dsp:8[SB/FB]	dsp:16[An]	dsp:16[SB]	abs16
Bytes/Cycles	3/3	3/3	3/4	4/4	4/4	5/4	5/4	5/4

## MOVA

### (1) MOVA src, dest



src	SRC	
dsp:8[An]	dsp:8[A0]	1 0 0 0
	dsp:8[A1]	1 0 0 1
dsp:8[SB/FB]	dsp:8[SB]	1 0 1 0
	dsp:8[FB]	1 0 1 1
dsp:16[An]	dsp:16[A0]	1 1 0 0
	dsp:16[A1]	1 1 0 1
dsp:16[SB]	dsp:16[SB]	1 1 1 0
abs16	abs16	1 1 1 1

dest	DEST
R0	0 0 0
R1	0 0 1
R2	0 1 0
R3	0 1 1
A0	1 0 0
A1	1 0 1

#### [ Number of Bytes/Number of Cycles ]

src	dsp:8[An]	dsp:8[SB/FB]	dsp:16[An]	dsp:16[SB]	abs16
Bytes/Cycles	3/2	3/2	4/2	4/2	4/2

# MOVDir

## (1) MOVDir RnL, dest



Dir	DIR
LL	0 0
LH	1 0
HL	0 1
HH	1 1

dest		DEST	dest		DEST
Rn	---	0 0 0 0	dsp:8[An]	dsp:8[A0]	1 0 0 0
	R0H	0 0 0 1		dsp:8[A1]	1 0 0 1
	R1L	0 0 1 0	dsp:8[SB/FB]	dsp:8[SB]	1 0 1 0
	R1H	0 0 1 1		dsp:8[FB]	1 0 1 1
An	---	0 1 0 0	dsp:16[An]	dsp:16[A0]	1 1 0 0
	---	0 1 0 1		dsp:16[A1]	1 1 0 1
[An]	[A0]	0 1 1 0	dsp:16[SB]	dsp:16[SB]	1 1 1 0
	[A1]	0 1 1 1	abs16	abs16	1 1 1 1

- Items marked --- cannot be selected.

### [ Number of Bytes/Number of Cycles ]

dest	Rn	[An]	dsp:8[An]	dsp:8[SB/FB]	dsp:16[An]	dsp:16[SB]	abs16
MOVHH, MOVLL	2/4	2/5	3/5	3/5	4/5	4/5	4/5
MOVHL, MOVLH	2/7	2/8	3/8	3/8	4/8	4/8	4/8

## MOVDir

(2) MOVDir src, R0L



Dir	DIR
LL	0 0
LH	1 0
HL	0 1
HH	1 1

src		SRC	src		SRC	
Rn	R0L	0 0 0 0	dsp:8[An]	dsp:8[A0]	1 0 0 0	
	R0H	0 0 0 1		dsp:8[A1]	1 0 0 1	
	R1L	0 0 1 0		dsp:8[SB/FB]	dsp:8[SB]	1 0 1 0
	R1H	0 0 1 1			dsp:8[FB]	1 0 1 1
An	---	0 1 0 0	dsp:16[An]	dsp:16[A0]	1 1 0 0	
	---	0 1 0 1		dsp:16[A1]	1 1 0 1	
[An]	[A0]	0 1 1 0	dsp:16[SB]	dsp:16[SB]	1 1 1 0	
	[A1]	0 1 1 1	abs16	abs16	1 1 1 1	

- Items marked --- cannot be selected.

### [ Number of Bytes/Number of Cycles ]

src	Rn	[An]	dsp:8[An]	dsp:8[SB/FB]	dsp:16[An]	dsp:16[SB]	abs16
MOVHH, MOVLL	2/3	2/5	3/5	3/5	4/5	4/5	4/5
MOVHL, MOVLH	2/6	2/8	3/8	3/8	4/8	4/8	4/8

# MUL

## (1) MUL.size #IMM, dest

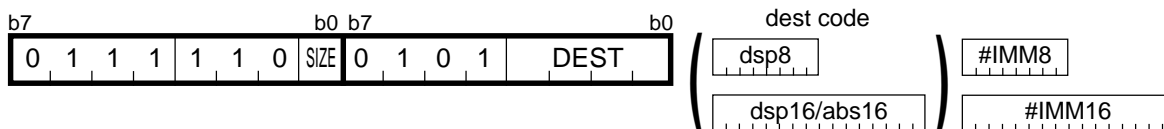

.size	SIZE
.B	0
.W	1

dest		DEST	dest		DEST
Rn	R0L/R0	0 0 0 0	dsp:8[An]	dsp:8[A0]	1 0 0 0
	--- /R1	0 0 0 1		dsp:8[A1]	1 0 0 1
	R1L/---	0 0 1 0	dsp:8[SB/FB]	dsp:8[SB]	1 0 1 0
	---	0 0 1 1		dsp:8[FB]	1 0 1 1
An	A0	0 1 0 0	dsp:16[An]	dsp:16[A0]	1 1 0 0
	---	0 1 0 1		dsp:16[A1]	1 1 0 1
[An]	[A0]	0 1 1 0	dsp:16[SB]	dsp:16[SB]	1 1 1 0
	[A1]	0 1 1 1	abs16	abs16	1 1 1 1

- Items marked --- cannot be selected.

### [ Number of Bytes/Number of Cycles ]

dest	Rn	An	[An]	dsp:8[An]	dsp:8[SB/FB]	dsp:16[An]	dsp:16[SB]	abs16
Bytes/Cycles	3/4	3/4	3/5	4/5	4/5	5/5	5/5	5/5

- If dest is Rn or An and the size specifier (.size) is (.W), the number of bytes and cycles indicated are increased by 1 each.
- If dest is neither Rn nor An and the size specifier (.size) is (.W), the number of bytes and cycles indicated are increased by 1 and 2, respectively.

# MUL

## (2) MUL.size src, dest

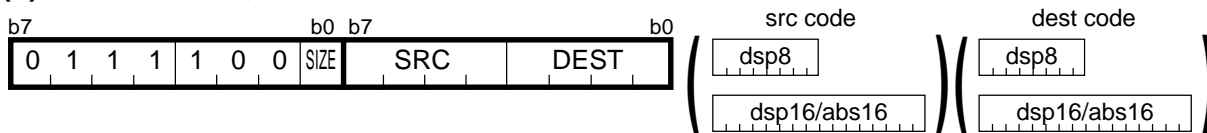

.size	SIZE
.B	0
.W	1

src		SRC	src		SRC
Rn	R0L/R0	0 0 0 0	dsp:8[An]	dsp:8[A0]	1 0 0 0
	R0H/R1	0 0 0 1		dsp:8[A1]	1 0 0 1
	R1L/R2	0 0 1 0	dsp:8[SB/FB]	dsp:8[SB]	1 0 1 0
	R1H/R3	0 0 1 1		dsp:8[FB]	1 0 1 1
An	A0	0 1 0 0	dsp:16[An]	dsp:16[A0]	1 1 0 0
	A1	0 1 0 1		dsp:16[A1]	1 1 0 1
[An]	[A0]	0 1 1 0	dsp:16[SB]	dsp:16[SB]	1 1 1 0
	[A1]	0 1 1 1	abs16	abs16	1 1 1 1

dest		DEST	dest		DEST
Rn	R0L/R0	0 0 0 0	dsp:8[An]	dsp:8[A0]	1 0 0 0
	--- /R1	0 0 0 1		dsp:8[A1]	1 0 0 1
	R1L/---	0 0 1 0	dsp:8[SB/FB]	dsp:8[SB]	1 0 1 0
	---	0 0 1 1		dsp:8[FB]	1 0 1 1
An	A0	0 1 0 0	dsp:16[An]	dsp:16[A0]	1 1 0 0
	---	0 1 0 1		dsp:16[A1]	1 1 0 1
[An]	[A0]	0 1 1 0	dsp:16[SB]	dsp:16[SB]	1 1 1 0
	[A1]	0 1 1 1	abs16	abs16	1 1 1 1

- Items marked --- cannot be selected.

### [ Number of Bytes/Number of Cycles ]

src \ dest	Rn	An	[An]	dsp:8[An]	dsp:8[SB/FB]	dsp:16[An]	dsp:16[SB]	abs16
Rn	2/4	2/4	2/5	3/5	3/5	4/5	4/5	4/5
An	2/4	2/5	2/5	3/5	3/5	4/5	4/5	4/5
[An]	2/6	2/6	2/6	3/6	3/6	4/6	4/6	4/6
dsp:8[An]	3/6	3/6	3/6	4/6	4/6	5/6	5/6	5/6
dsp:8[SB/FB]	3/6	3/6	3/6	4/6	4/6	5/6	5/6	5/6
dsp:16[An]	4/6	4/6	4/6	5/6	5/6	6/6	6/6	6/6
dsp:16[SB]	4/6	4/6	4/6	5/6	5/6	6/6	6/6	6/6
abs16	4/6	4/6	4/6	5/6	5/6	6/6	6/6	6/6

- If src is An and dest is Rn and the size specifier (.size) is (.W), the number of cycles indicated is increased by 1.
- If src is not An and dest is Rn or An and the size specifier (.size) is (.W), the number of cycles indicated is increased by 1.
- If dest is neither Rn nor An and the size specifier (.size) is (.W), the number of cycles indicated is increased by 2.

# MULU

## (1) MULU.size #IMM, dest

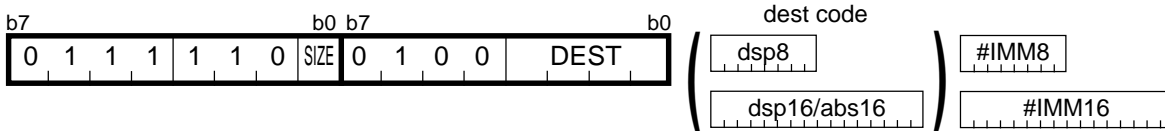

.size	SIZE
.B	0
.W	1

dest		DEST	dest		DEST
Rn	R0L/R0	0 0 0 0	dsp:8[An]	dsp:8[A0]	1 0 0 0
	--- /R1	0 0 0 1		dsp:8[A1]	1 0 0 1
	R1L/---	0 0 1 0	dsp:8[SB/FB]	dsp:8[SB]	1 0 1 0
	---	0 0 1 1		dsp:8[FB]	1 0 1 1
An	A0	0 1 0 0	dsp:16[An]	dsp:16[A0]	1 1 0 0
	---	0 1 0 1		dsp:16[A1]	1 1 0 1
[An]	[A0]	0 1 1 0	dsp:16[SB]	dsp:16[SB]	1 1 1 0
	[A1]	0 1 1 1	abs16	abs16	1 1 1 1

- Items marked --- cannot be selected.

### [ Numbera of Bytes/Number of Cycles ]

dest	Rn	An	[An]	dsp:8[An]	dsp:8[SB/FB]	dsp:16[An]	dsp:16[SB]	abs16
Bytes/Cycles	3/4	3/4	3/5	4/5	4/5	5/5	5/5	5/5

- If dest is Rn or An and the size specifier (.size) is (.W), the number of bytes and cycles indicated are increased by 1 each.
- If dest is neither Rn nor An and the size specifier (.size) is (.W), the number of bytes and cycles indicated are increased by 1 and 2, respectively.

# MULU

## (2) MULU.size src, dest

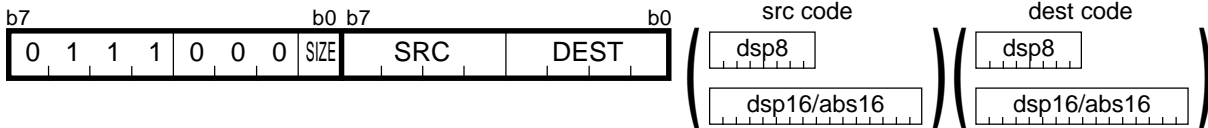

.size	SIZE
.B	0
.W	1

src		SRC	src		SRC
Rn	R0L/R0	0 0 0 0	dsp:8[An]	dsp:8[A0]	1 0 0 0
	R0H/R1	0 0 0 1		dsp:8[A1]	1 0 0 1
	R1L/R2	0 0 1 0	dsp:8[SB/FB]	dsp:8[SB]	1 0 1 0
	R1H/R3	0 0 1 1		dsp:8[FB]	1 0 1 1
An	A0	0 1 0 0	dsp:16[An]	dsp:16[A0]	1 1 0 0
	A1	0 1 0 1		dsp:16[A1]	1 1 0 1
[An]	[A0]	0 1 1 0	dsp:16[SB]	dsp:16[SB]	1 1 1 0
	[A1]	0 1 1 1	abs16	abs16	1 1 1 1

dest		DEST	dest		DEST
Rn	R0L/R0	0 0 0 0	dsp:8[An]	dsp:8[A0]	1 0 0 0
	--- /R1	0 0 0 1		dsp:8[A1]	1 0 0 1
	R1L/---	0 0 1 0	dsp:8[SB/FB]	dsp:8[SB]	1 0 1 0
	---	0 0 1 1		dsp:8[FB]	1 0 1 1
An	A0	0 1 0 0	dsp:16[An]	dsp:16[A0]	1 1 0 0
	---	0 1 0 1		dsp:16[A1]	1 1 0 1
[An]	[A0]	0 1 1 0	dsp:16[SB]	dsp:16[SB]	1 1 1 0
	[A1]	0 1 1 1	abs16	abs16	1 1 1 1

- Items marked --- cannot be selected.

### [ Number of Bytes/Number of Cycles ]

src \ dest	Rn	An	[An]	dsp:8[An]	dsp:8[SB/FB]	dsp:16[An]	dsp:16[SB]	abs16
Rn	2/4	2/4	2/5	3/5	3/5	4/5	4/5	4/5
An	2/4	2/5	2/5	3/5	3/5	4/5	4/5	4/5
[An]	2/6	2/6	2/6	3/6	3/6	4/6	4/6	4/6
dsp:8[An]	3/6	3/6	3/6	4/6	4/6	5/6	5/6	5/6
dsp:8[SB/FB]	3/6	3/6	3/6	4/6	4/6	5/6	5/6	5/6
dsp:16[An]	4/6	4/6	4/6	5/6	5/6	6/6	6/6	6/6
dsp:16[SB]	4/6	4/6	4/6	5/6	5/6	6/6	6/6	6/6
abs16	4/6	4/6	4/6	5/6	5/6	6/6	6/6	6/6

- If src is An and dest is Rn and the size specifier (.size) is (.W), the number of cycles indicated is increased by 1.
- If src is not An and dest is Rn or An and the size specifier (.size) is (.W), the number of cycles indicated is increased by 1.
- If dest is neither Rn nor An and the size specifier (.size) is (.W), the number of cycles indicated is increased by 2.

# NEG

## (1) NEG.size dest

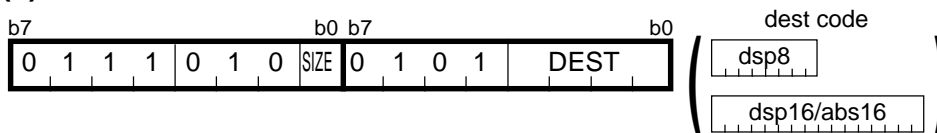

.size	SIZE
.B	0
.W	1

		dest	DEST			dest	DEST
Rn	R0L/R0		0 0 0 0	dsp:8[An]	dsp:8[A0]	1 0 0 0	
	R0H/R1		0 0 0 1		dsp:8[A1]	1 0 0 1	
	R1L/R2		0 0 1 0	dsp:8[SB/FB]	dsp:8[SB]	1 0 1 0	
	R1H/R3		0 0 1 1		dsp:8[FB]	1 0 1 1	
An	A0		0 1 0 0	dsp:16[An]	dsp:16[A0]	1 1 0 0	
	A1		0 1 0 1		dsp:16[A1]	1 1 0 1	
[An]	[A0]		0 1 1 0	dsp:16[SB]	dsp:16[SB]	1 1 1 0	
	[A1]		0 1 1 1	abs16	abs16	1 1 1 1	

### [ Number of Bytes/Number of Cycles ]

dest	Rn	An	[An]	dsp:8[An]	dsp:8[SB/FB]	dsp:16[An]	dsp:16[SB]	abs16
Bytes/Cycles	2/1	2/1	2/3	3/3	3/3	4/3	4/3	4/3

# NOP

## (1) NOP

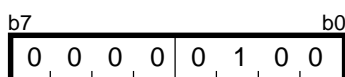

### [ Number of Bytes/Number of Cycles ]

Bytes/Cycles	1/1
--------------	-----

# NOT

## (1) NOT.size:G dest

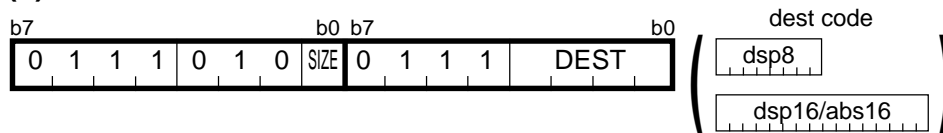

.size	SIZE
.B	0
.W	1

dest		DEST	dest		DEST
Rn	R0L/R0	0 0 0 0	dsp:8[An]	dsp:8[A0]	1 0 0 0
	R0H/R1	0 0 0 1		dsp:8[A1]	1 0 0 1
	R1L/R2	0 0 1 0	dsp:8[SB/FB]	dsp:8[SB]	1 0 1 0
	R1H/R3	0 0 1 1		dsp:8[FB]	1 0 1 1
An	A0	0 1 0 0	dsp:16[An]	dsp:16[A0]	1 1 0 0
	A1	0 1 0 1		dsp:16[A1]	1 1 0 1
[An]	[A0]	0 1 1 0	dsp:16[SB]	dsp:16[SB]	1 1 1 0
	[A1]	0 1 1 1	abs16	abs16	1 1 1 1

### [ Number of Bytes/Number of Cycles ]

dest	Rn	An	[An]	dsp:8[An]	dsp:8[SB/FB]	dsp:16[An]	dsp:16[SB]	abs16
Bytes/Cycles	2/1	2/1	2/3	3/3	3/3	4/3	4/3	4/3

# NOT

## (2) NOT.B:S dest

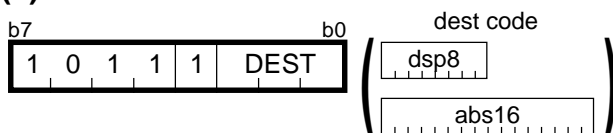

dest		DEST
Rn	R0H	0 1 1
	R0L	1 0 0
dsp:8[SB/FB]	dsp:8[SB]	1 0 1
	dsp:8[FB]	1 1 0
abs16	abs16	1 1 1

### [ Number of Bytes/Number of Cycles ]

dest	Rn	dsp:8[SB/FB]	abs16
Bytes/Cycles	1/1	2/3	3/3

# OR

## (1) OR.size:G #IMM, dest

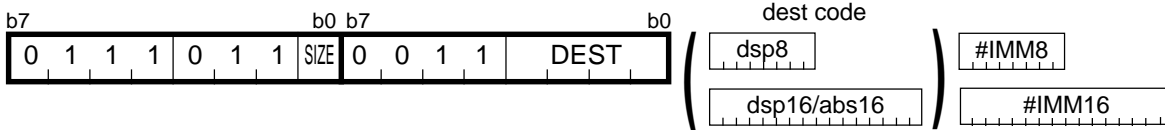

.size	SIZE
.B	0
.W	1

dest		DEST	dest		DEST	
Rn	R0L/R0	0 0 0 0	dsp:8[An]	dsp:8[A0]	1 0 0 0	
	R0H/R1	0 0 0 1		dsp:8[A1]	1 0 0 1	
	R1L/R2	0 0 1 0		dsp:8[SB/FB]	dsp:8[SB]	1 0 1 0
	R1H/R3	0 0 1 1			dsp:8[FB]	1 0 1 1
An	A0	0 1 0 0	dsp:16[An]	dsp:16[A0]	1 1 0 0	
	A1	0 1 0 1		dsp:16[A1]	1 1 0 1	
[An]	[A0]	0 1 1 0	dsp:16[SB]	dsp:16[SB]	1 1 1 0	
	[A1]	0 1 1 1	abs16	abs16	1 1 1 1	

### [ Number of Bytes/Number of Cycles ]

dest	Rn	An	[An]	dsp:8[An]	dsp:8[SB/FB]	dsp:16[An]	dsp:16[SB]	abs16
Bytes/Cycles	3/2	3/2	3/4	4/4	4/4	5/4	5/4	5/4

- If the size specifier (.size) is (.W), the number of bytes indicated is increased by 1.

# OR

## (2) OR.B:S #IMM8, dest

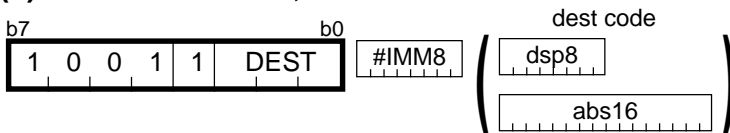

dest		DEST
Rn	R0H	0 1 1
	R0L	1 0 0
dsp:8[SB/FB]	dsp:8[SB]	1 0 1
	dsp:8[FB]	1 1 0
abs16	abs16	1 1 1

### [ Number of Bytes/Number of Cycles ]

dest	Rn	dsp:8[SB/FB]	abs16
Bytes/Cycles	2/1	3/3	4/3

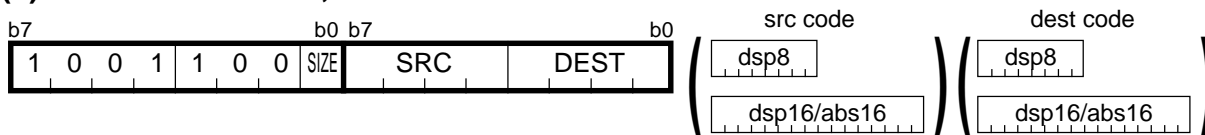
**OR****(3) OR.size:G src, dest**

.size	SIZE
.B	0
.W	1

src/dest		SRC/DEST	src/dest		SRC/DEST
Rn	R0L/R0	0 0 0 0	dsp:8[An]	dsp:8[A0]	1 0 0 0
	R0H/R1	0 0 0 1		dsp:8[A1]	1 0 0 1
	R1L/R2	0 0 1 0	dsp:8[SB/FB]	dsp:8[SB]	1 0 1 0
	R1H/R3	0 0 1 1		dsp:8[FB]	1 0 1 1
An	A0	0 1 0 0	dsp:16[An]	dsp:16[A0]	1 1 0 0
	A1	0 1 0 1		dsp:16[A1]	1 1 0 1
[An]	[A0]	0 1 1 0	dsp:16[SB]	dsp:16[SB]	1 1 1 0
	[A1]	0 1 1 1	abs16	abs16	1 1 1 1

**[ Number of Bytes/Number of Cycles ]**

src \ dest	Rn	An	[An]	dsp:8[An]	dsp:8[SB/FB]	dsp:16[An]	dsp:16[SB]	abs16
Rn	2/2	2/2	2/3	3/3	3/3	4/3	4/3	4/3
An	2/2	2/2	2/3	3/3	3/3	4/3	4/3	4/3
[An]	2/3	2/3	2/4	3/4	3/4	4/4	4/4	4/4
dsp:8[An]	3/3	3/3	3/4	4/4	4/4	5/4	5/4	5/4
dsp:8[SB/FB]	3/3	3/3	3/4	4/4	4/4	5/4	5/4	5/4
dsp:16[An]	4/3	4/3	4/4	5/4	5/4	6/4	6/4	6/4
dsp:16[SB]	4/3	4/3	4/4	5/4	5/4	6/4	6/4	6/4
abs16	4/3	4/3	4/4	5/4	5/4	6/4	6/4	6/4

# OR

## (4) OR.B:S src, R0L/R0H

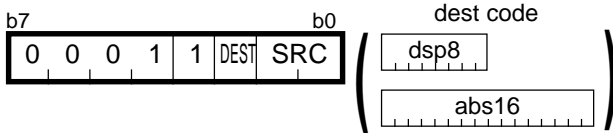

src		SRC
Rn	R0L/R0H	0 0
dsp:8[SB/FB]	dsp:8[SB]	0 1
	dsp:8[FB]	1 0
abs16	abs16	1 1

dest	DEST
R0L	0
R0H	1

### [ Number of Bytes/Number of Cycles ]

src	Rn	dsp:8[SB/FB]	abs16
Bytes/Cycles	1/2	2/3	3/3

# POP

## (1) POP.size:G dest

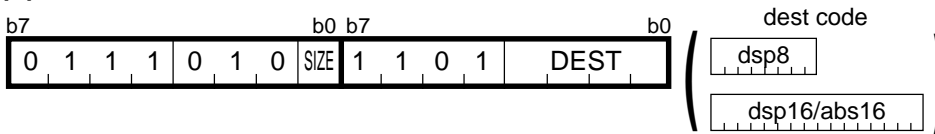

.size	SIZE
.B	0
.W	1

dest		DEST	dest		DEST	
Rn	R0L/R0	0 0 0 0	dsp:8[An]	dsp:8[A0]	1 0 0 0	
	R0H/R1	0 0 0 1		dsp:8[A1]	1 0 0 1	
	R1L/R2	0 0 1 0		dsp:8[SB/FB]	dsp:8[SB]	1 0 1 0
	R1H/R3	0 0 1 1			dsp:8[FB]	1 0 1 1
An	A0	0 1 0 0	dsp:16[An]	dsp:16[A0]	1 1 0 0	
	A1	0 1 0 1		dsp:16[A1]	1 1 0 1	
[An]	[A0]	0 1 1 0	dsp:16[SB]	dsp:16[SB]	1 1 1 0	
	[A1]	0 1 1 1	abs16	abs16	1 1 1 1	

### [ Number of Bytes/Number of Cycles ]

dest	Rn	An	[An]	dsp:8[An]	dsp:8[SB/FB]	dsp:16[An]	dsp:16[SB]	abs16
Bytes/Cycles	2/3	2/3	2/4	3/4	3/4	4/4	4/4	4/4

## POP

### (2) POP.B:S dest



dest	DEST
ROL	0
ROH	1

[ Number of Bytes/Number of Cycles ]

Bytes/Cycles	1/3
--------------	-----

## POP

### (3) POP.W:S dest



dest	DEST
A0	0
A1	1

[ Number of Bytes/Number of Cycles ]

Bytes/Cycles	1/3
--------------	-----

# POPC

## (1) POPC dest

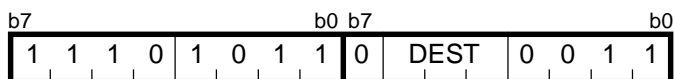

dest	DEST	dest	DEST
---	0 0 0	ISP	1 0 0
INTBL	0 0 1	SP	1 0 1
INTBH	0 1 0	SB	1 1 0
FLG	0 1 1	FB	1 1 1

- Items marked --- cannot be selected.

### [ Number of Bytes/Number of Cycles ]

Bytes/Cycles	2/3
--------------	-----

# POPM

## (1) POPM dest

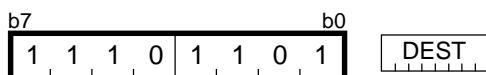

dest							
FB	SB	A1	A0	R3	R2	R1	R0
DEST <sup>2</sup>							

- The bit for a selected register is 1.  
The bit for a non-selected register is 0.

### [ Number of Bytes/Number of Cycles ]

Bytes/Cycles	2/3
--------------	-----

- If two or more registers need to be restored, the number of required cycles is 2 x m (m: number of registers to be restored).

# PUSH

## (1) PUSH.size:G #IMM

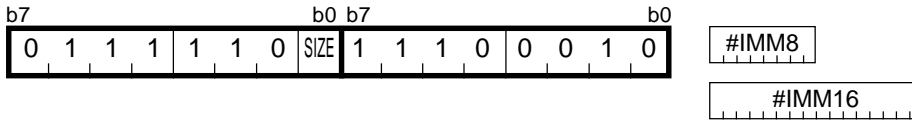

.size	SIZE
.B	0
.W	1

### [ Number of Bytes/Number of Cycles ]

Bytes/Cycles	3/2
--------------	-----

- If the size specifier (.size) is (.W), the number of bytes indicated is increased by 1.

# PUSH

## (2) PUSH.size:G src

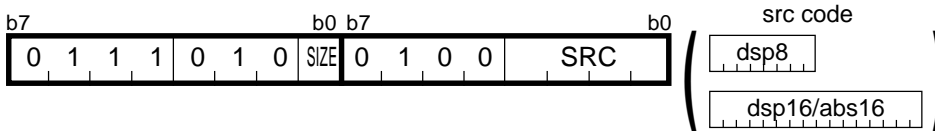

.size	SIZE
.B	0
.W	1

		src	SRC			src	SRC
Rn	R0L/R0		0 0 0 0	dsp:8[An]	dsp:8[A0]		1 0 0 0
	R0H/R1		0 0 0 1		dsp:8[A1]		1 0 0 1
	R1L/R2		0 0 1 0	dsp:8[SB/FB]	dsp:8[SB]		1 0 1 0
	R1H/R3		0 0 1 1		dsp:8[FB]		1 0 1 1
An	A0		0 1 0 0	dsp:16[An]	dsp:16[A0]		1 1 0 0
	A1		0 1 0 1		dsp:16[A1]		1 1 0 1
[An]	[A0]		0 1 1 0	dsp:16[SB]		dsp:16[SB]	1 1 1 0
	[A1]		0 1 1 1	abs16		abs16	1 1 1 1

### [ Number of Bytes/Number of Cycles ]

src	Rn	An	[An]	dsp:8[An]	dsp:8[SB/FB]	dsp:16[An]	dsp:16[SB]	abs16
Bytes/Cycles	2/2	2/2	2/4	3/4	3/4	4/4	4/4	4/4

## PUSH

### (3) PUSH.B:S src

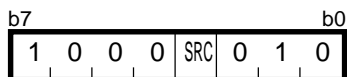

src	SRC
R0L	0
R0H	1

[ Number of Bytes/Number of Cycles ]

Bytes/Cycles	1/2
--------------	-----

## PUSH

### (4) PUSH.W:S src

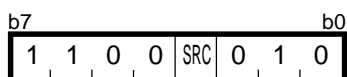

src	SRC
A0	0
A1	1

[ Number of Bytes/Number of Cycles ]

Bytes/Cycles	1/2
--------------	-----

# PUSHA

## (1) PUSHA src

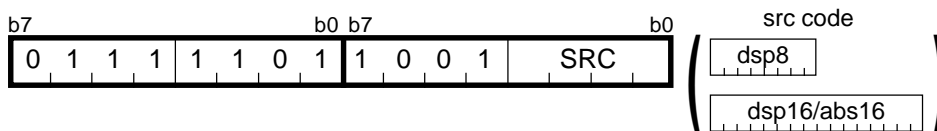

src		SRC
dsp:8[An]	dsp:8[A0]	1 0 0 0
	dsp:8[A1]	1 0 0 1
dsp:8[SB/FB]	dsp:8[SB]	1 0 1 0
	dsp:8[FB]	1 0 1 1
dsp:16[An]	dsp:16[A0]	1 1 0 0
	dsp:16[A1]	1 1 0 1
dsp:16[SB]	dsp:16[SB]	1 1 1 0
abs16	abs16	1 1 1 1

### [ Number of Bytes/Number of Cycles ]

src	dsp:8[An]	dsp:8[SB/FB]	dsp:16[An]	dsp:16[SB]	abs:16
Bytes/Cycles	3/2	3/2	4/2	4/2	4/2

# PUSHC

## (1) PUSHC src

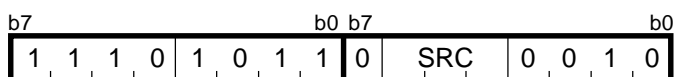

src	SRC	src	SRC
---	0 0 0	ISP	1 0 0
INTBL	0 0 1	SP	1 0 1
INTBH	0 1 0	SB	1 1 0
FLG	0 1 1	FB	1 1 1

- Items marked --- cannot be selected.

### [ Number of Bytes/Number of Cycles ]

Bytes/Cycles	2/2
--------------	-----



# RMPA

## (1) RMPA.size

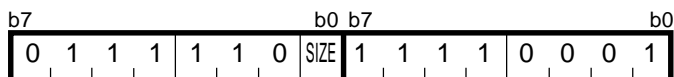

.size	SIZE
.B	0
.W	1

### [ Number of Bytes/Number of Cycles ]

Bytes/Cycles	$2/4+7 \times m$
--------------	------------------

- m denotes the number of operations to be performed.
- If the size specifier (.size) is (.W), the number of cycles is  $(6+9 \times m)$ .

# ROLC

## (1) ROLC.size dest

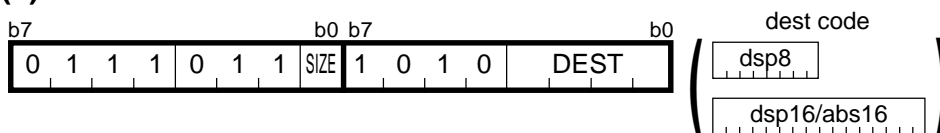

.size	SIZE
.B	0
.W	1

dest		DEST	dest		DEST
Rn	ROL/R0	0 0 0 0	dsp:8[An]	dsp:8[A0]	1 0 0 0
	R0H/R1	0 0 0 1		dsp:8[A1]	1 0 0 1
	R1L/R2	0 0 1 0	dsp:8[SB/FB]	dsp:8[SB]	1 0 1 0
	R1H/R3	0 0 1 1		dsp:8[FB]	1 0 1 1
An	A0	0 1 0 0	dsp:16[An]	dsp:16[A0]	1 1 0 0
	A1	0 1 0 1		dsp:16[A1]	1 1 0 1
[An]	[A0]	0 1 1 0	dsp:16[SB]	dsp:16[SB]	1 1 1 0
	[A1]	0 1 1 1	abs16	abs16	1 1 1 1

### [ Number of Bytes/Number of Cycles ]

dest	Rn	An	[An]	dsp:8[An]	dsp:8[SB/FB]	dsp:16[An]	dsp:16[SB]	abs16
Bytes/Cycles	2/1	2/1	2/3	3/3	3/3	4/3	4/3	4/3

# RORC

## (1) RORC.size dest

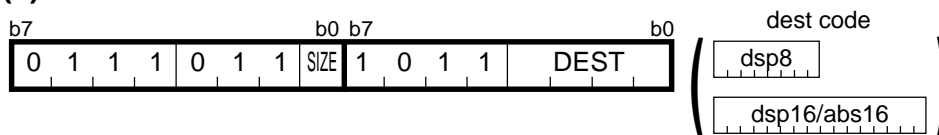

.size	SIZE
.B	0
.W	1

		dest	DEST			dest	DEST
Rn	R0L/R0		0 0 0 0	dsp:8[An]	dsp:8[A0]	1 0 0 0	
	R0H/R1		0 0 0 1		dsp:8[A1]	1 0 0 1	
	R1L/R2		0 0 1 0	dsp:8[SB/FB]	dsp:8[SB]	1 0 1 0	
	R1H/R3		0 0 1 1		dsp:8[FB]	1 0 1 1	
An	A0		0 1 0 0	dsp:16[An]	dsp:16[A0]	1 1 0 0	
	A1		0 1 0 1		dsp:16[A1]	1 1 0 1	
[An]	[A0]		0 1 1 0	dsp:16[SB]	dsp:16[SB]	1 1 1 0	
	[A1]		0 1 1 1	abs16	abs16	1 1 1 1	

### [ Number of Bytes/Number of Cycles ]

dest	Rn	An	[An]	dsp:8[An]	dsp:8[SB/FB]	dsp:16[An]	dsp:16[SB]	abs16
Bytes/Cycles	2/1	2/1	2/3	3/3	3/3	4/3	4/3	4/3

# ROT

## (1) ROT.size #IMM, dest

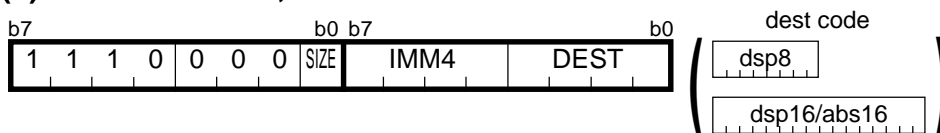

.size	SIZE
.B	0
.W	1

#IMM	IMM4	#IMM	IMM4
+1	0 0 0 0	-1	1 0 0 0
+2	0 0 0 1	-2	1 0 0 1
+3	0 0 1 0	-3	1 0 1 0
+4	0 0 1 1	-4	1 0 1 1
+5	0 1 0 0	-5	1 1 0 0
+6	0 1 0 1	-6	1 1 0 1
+7	0 1 1 0	-7	1 1 1 0
+8	0 1 1 1	-8	1 1 1 1

dest		DEST	dest		DEST
Rn	R0L/R0	0 0 0 0	dsp:8[An]	dsp:8[A0]	1 0 0 0
	R0H/R1	0 0 0 1		dsp:8[A1]	1 0 0 1
	R1L/R2	0 0 1 0	dsp:8[SB/FB]	dsp:8[SB]	1 0 1 0
	R1H/R3	0 0 1 1		dsp:8[FB]	1 0 1 1
An	A0	0 1 0 0	dsp:16[An]	dsp:16[A0]	1 1 0 0
	A1	0 1 0 1		dsp:16[A1]	1 1 0 1
[An]	[A0]	0 1 1 0	dsp:16[SB]	dsp:16[SB]	1 1 1 0
	[A1]	0 1 1 1	abs16	abs16	1 1 1 1

### [ Number of Bytes/Number of Cycles ]

dest	Rn	An	[An]	dsp:8[An]	dsp:8[SB/FB]	dsp:16[An]	dsp:16[SB]	abs16
Bytes/Cycles	2/1+m	2/1+m	2/2+m	3/2+m	3/2+m	4/2+m	4/2+m	4/2+m

- m denotes the number of bits to be rotated.

# ROT

## (2) ROT.size R1H, dest

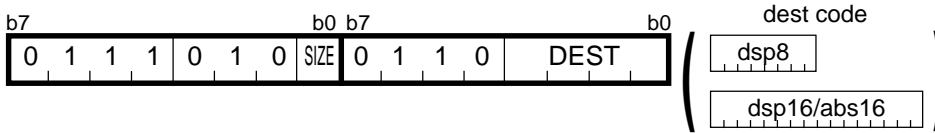

.size	SIZE
.B	0
.W	1

dest		DEST	dest		DEST
Rn	R0L/R0	0 0 0 0	dsp:8[An]	dsp:8[A0]	1 0 0 0
	R0H/---	0 0 0 1		dsp:8[A1]	1 0 0 1
	R1L/R2	0 0 1 0	dsp:8[SB/FB]	dsp:8[SB]	1 0 1 0
	--- /R3	0 0 1 1		dsp:8[FB]	1 0 1 1
An	A0	0 1 0 0	dsp:16[An]	dsp:16[A0]	1 1 0 0
	A1	0 1 0 1		dsp:16[A1]	1 1 0 1
[An]	[A0]	0 1 1 0	dsp:16[SB]	dsp:16[SB]	1 1 1 0
	[A1]	0 1 1 1	abs16	abs16	1 1 1 1

- Items marked --- cannot be selected.

### [ Number of Bytes/Number of Cycles ]

dest	Rn	An	[An]	dsp:8[An]	dsp:8[SB/FB]	dsp:16[An]	dsp:16[SB]	abs16
Bytes/Cycles	2/2+m	2/2+m	2/3+m	3/3+m	3/3+m	4/3+m	4/3+m	4/3+m

- m denotes the number of bits to be rotated.

# RTS

## (1) RTS

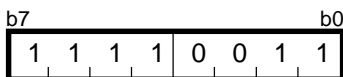

### [ Number of Bytes/Number of Cycles ]

Bytes/Cycles	1/6
--------------	-----

# SBB

## (1) SBB.size #IMM, dest

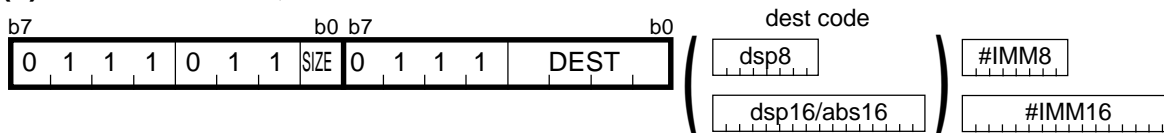

.size	SIZE
.B	0
.W	1

dest		DEST	dest		DEST
Rn	R0L/R0	0 0 0 0	dsp:8[An]	dsp:8[A0]	1 0 0 0
	R0H/R1	0 0 0 1		dsp:8[A1]	1 0 0 1
	R1L/R2	0 0 1 0	dsp:8[SB/FB]	dsp:8[SB]	1 0 1 0
	R1H/R3	0 0 1 1		dsp:8[FB]	1 0 1 1
An	A0	0 1 0 0	dsp:16[An]	dsp:16[A0]	1 1 0 0
	A1	0 1 0 1		dsp:16[A1]	1 1 0 1
[An]	[A0]	0 1 1 0	dsp:16[SB]	dsp:16[SB]	1 1 1 0
	[A1]	0 1 1 1	abs16	abs16	1 1 1 1

### [ Number of Bytes/Number of Cycles ]

dest	Rn	An	[An]	dsp:8[An]	dsp:8[SB/FB]	dsp:16[An]	dsp:16[SB]	abs16
Bytes/Cycles	3/2	3/2	3/4	4/4	4/4	5/4	5/4	5/4

- If the size specifier (.size) is (.W), the number of bytes indicated is increased by 1.

# SBB

## (2) SBB.size src, dest

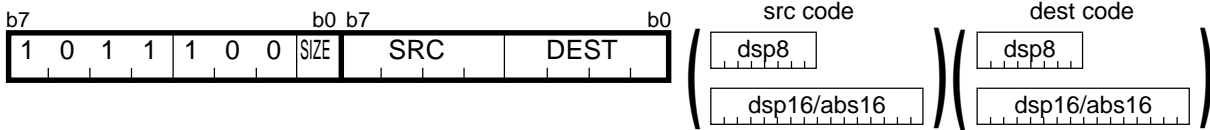

.size	SIZE
.B	0
.W	1

src/dest		SRC/DEST	src/dest		SRC/DEST
Rn	R0L/R0	0 0 0 0	dsp:8[An]	dsp:8[A0]	1 0 0 0
	R0H/R1	0 0 0 1		dsp:8[A1]	1 0 0 1
	R1L/R2	0 0 1 0	dsp:8[SB/FB]	dsp:8[SB]	1 0 1 0
	R1H/R3	0 0 1 1		dsp:8[FB]	1 0 1 1
An	A0	0 1 0 0	dsp:16[An]	dsp:16[A0]	1 1 0 0
	A1	0 1 0 1		dsp:16[A1]	1 1 0 1
[An]	[A0]	0 1 1 0	dsp:16[SB]	dsp:16[SB]	1 1 1 0
	[A1]	0 1 1 1	abs16	abs16	1 1 1 1

### [ Number of Bytes/Number of Cycles ]

src \ dest	Rn	An	[An]	dsp:8[An]	dsp:8[SB/FB]	dsp:16[An]	dsp:16[SB]	abs16
Rn	2/2	2/2	2/3	3/3	3/3	4/3	4/3	4/3
An	2/2	2/2	2/3	3/3	3/3	4/3	4/3	4/3
[An]	2/3	2/3	2/4	3/4	3/4	4/4	4/4	4/4
dsp:8[An]	3/3	3/3	3/4	4/4	4/4	5/4	5/4	5/4
dsp:8[SB/FB]	3/3	3/3	3/4	4/4	4/4	5/4	5/4	5/4
dsp:16[An]	4/3	4/3	4/4	5/4	5/4	6/4	6/4	6/4
dsp:16[SB]	4/3	4/3	4/4	5/4	5/4	6/4	6/4	6/4
abs16	4/3	4/3	4/4	5/4	5/4	6/4	6/4	6/4

# SBJNZ

## (1) SBJNZ.size #IMM, dest, label

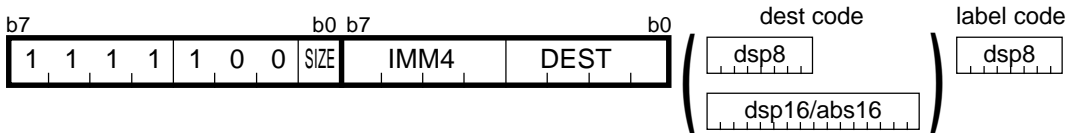

dsp8 (label code) = address indicated by label – (start address of instruction + 2)

.size	SIZE
.B	0
.W	1

#IMM	IMM4	#IMM	IMM4
0	0 0 0 0	+8	1 0 0 0
-1	0 0 0 1	+7	1 0 0 1
-2	0 0 1 0	+6	1 0 1 0
-3	0 0 1 1	+5	1 0 1 1
-4	0 1 0 0	+4	1 1 0 0
-5	0 1 0 1	+3	1 1 0 1
-6	0 1 1 0	+2	1 1 1 0
-7	0 1 1 1	+1	1 1 1 1

dest		DEST	dest		DEST
Rn	R0L/R0	0 0 0 0	dsp:8[An]	dsp:8[A0]	1 0 0 0
	R0H/R1	0 0 0 1		dsp:8[A1]	1 0 0 1
	R1L/R2	0 0 1 0	dsp:8[SB/FB]	dsp:8[SB]	1 0 1 0
	R1H/R3	0 0 1 1		dsp:8[FB]	1 0 1 1
An	A0	0 1 0 0	dsp:16[An]	dsp:16[A0]	1 1 0 0
	A1	0 1 0 1		dsp:16[A1]	1 1 0 1
[An]	[A0]	0 1 1 0	dsp:16[SB]	dsp:16[SB]	1 1 1 0
	[A1]	0 1 1 1	abs16	abs16	1 1 1 1

### [ Number of Bytes/Number of Cycles ]

dest	Rn	An	[An]	dsp:8[An]	dsp:8[SB/FB]	dsp:16[An]	dsp:16[SB]	abs16
Bytes/Cycles	3/3	3/3	3/5	4/5	4/5	5/5	5/5	5/5

- If the program branches to a label, the number of cycles indicated is increased by 4.

# SHA

## (1) SHA.size #IMM, dest

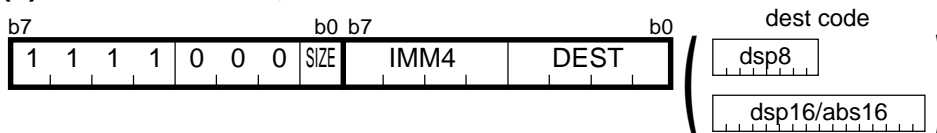

.size	SIZE
.B	0
.W	1

#IMM	IMM4	#IMM	IMM4
+1	0 0 0 0	-1	1 0 0 0
+2	0 0 0 1	-2	1 0 0 1
+3	0 0 1 0	-3	1 0 1 0
+4	0 0 1 1	-4	1 0 1 1
+5	0 1 0 0	-5	1 1 0 0
+6	0 1 0 1	-6	1 1 0 1
+7	0 1 1 0	-7	1 1 1 0
+8	0 1 1 1	-8	1 1 1 1

dest		DEST	dest		DEST
Rn	R0L/R0	0 0 0 0	dsp:8[An]	dsp:8[A0]	1 0 0 0
	R0H/R1	0 0 0 1		dsp:8[A1]	1 0 0 1
	R1L/R2	0 0 1 0	dsp:8[SB/FB]	dsp:8[SB]	1 0 1 0
	R1H/R3	0 0 1 1		dsp:8[FB]	1 0 1 1
An	A0	0 1 0 0	dsp:16[An]	dsp:16[A0]	1 1 0 0
	A1	0 1 0 1		dsp:16[A1]	1 1 0 1
[An]	[A0]	0 1 1 0	dsp:16[SB]	dsp:16[SB]	1 1 1 0
	[A1]	0 1 1 1	abs16	abs16	1 1 1 1

### [ Number of Bytes/Number of Cycles ]

dest	Rn	An	[An]	dsp:8[An]	dsp:8[SB/FB]	dsp:16[An]	dsp:16[SB]	abs16
Bytes/Cycles	2/1+m	2/1+m	2/2+m	3/2+m	3/2+m	4/2+m	4/2+m	4/2+m

- m denotes the number of bits to be shifted.

# SHA

## (2) SHA.size R1H, dest

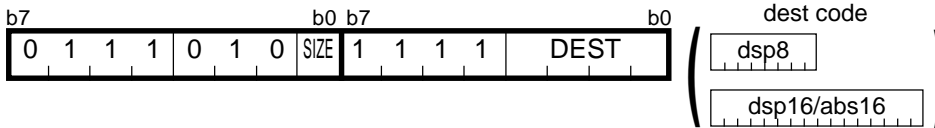

.size	SIZE
.B	0
.W	1

dest		DEST	dest		DEST
Rn	R0L/R0	0 0 0 0	dsp:8[An]	dsp:8[A0]	1 0 0 0
	R0H/---	0 0 0 1		dsp:8[A1]	1 0 0 1
	R1L/R2	0 0 1 0	dsp:8[SB/FB]	dsp:8[SB]	1 0 1 0
	--- /R3	0 0 1 1		dsp:8[FB]	1 0 1 1
An	A0	0 1 0 0	dsp:16[An]	dsp:16[A0]	1 1 0 0
	A1	0 1 0 1		dsp:16[A1]	1 1 0 1
[An]	[A0]	0 1 1 0	dsp:16[SB]	dsp:16[SB]	1 1 1 0
	[A1]	0 1 1 1	abs16	abs16	1 1 1 1

- Items marked --- cannot be selected.

### [ Number of Bytes/Number of Cycles ]

dest	Rn	An	[An]	dsp:8[An]	dsp:8[SB/FB]	dsp:16[An]	dsp:16[SB]	abs16
Bytes/Cycles	2/2+m	2/2+m	2/3+m	3/3+m	3/3+m	4/3+m	4/3+m	4/3+m

- m denotes the number of bits to be shifted.

# SHA

## (3) SHA.L #IMM, dest

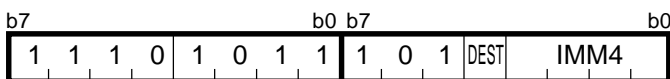

#IMM	IMM4	#IMM	IMM4
+1	0 0 0 0	-1	1 0 0 0
+2	0 0 0 1	-2	1 0 0 1
+3	0 0 1 0	-3	1 0 1 0
+4	0 0 1 1	-4	1 0 1 1
+5	0 1 0 0	-5	1 1 0 0
+6	0 1 0 1	-6	1 1 0 1
+7	0 1 1 0	-7	1 1 1 0
+8	0 1 1 1	-8	1 1 1 1

dest	DEST
R2R0	0
R3R1	1

### [ Number of Bytes/Number of Cycles ]

Bytes/Cycles	2/3+m
--------------	-------

- m denotes the number of bits to be shifted.

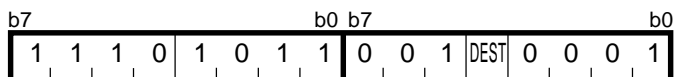
**SHA****(4) SHA.L R1H, dest**

dest	DEST
R2R0	0
R3R1	1

**[ Number of Bytes/Number of Cycles ]**

Bytes/Cycles	2/4+m
--------------	-------

- m denotes the number of bits to be shifted.

# SHL

## (1) SHL.size #IMM, dest

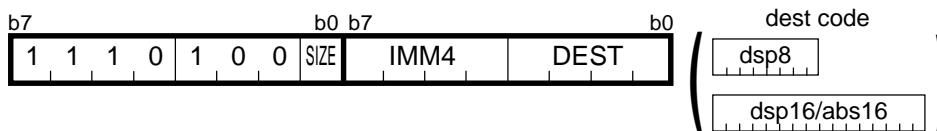

.size	SIZE
.B	0
.W	1

#IMM	IMM4	#IMM	IMM4
+1	0 0 0 0	-1	1 0 0 0
+2	0 0 0 1	-2	1 0 0 1
+3	0 0 1 0	-3	1 0 1 0
+4	0 0 1 1	-4	1 0 1 1
+5	0 1 0 0	-5	1 1 0 0
+6	0 1 0 1	-6	1 1 0 1
+7	0 1 1 0	-7	1 1 1 0
+8	0 1 1 1	-8	1 1 1 1

dest		DEST	dest		DEST
Rn	R0L/R0	0 0 0 0	dsp:8[An]	dsp:8[A0]	1 0 0 0
	R0H/R1	0 0 0 1		dsp:8[A1]	1 0 0 1
	R1L/R2	0 0 1 0	dsp:8[SB/FB]	dsp:8[SB]	1 0 1 0
	R1H/R3	0 0 1 1		dsp:8[FB]	1 0 1 1
An	A0	0 1 0 0	dsp:16[An]	dsp:16[A0]	1 1 0 0
	A1	0 1 0 1		dsp:16[A1]	1 1 0 1
[An]	[A0]	0 1 1 0	dsp:16[SB]	dsp:16[SB]	1 1 1 0
	[A1]	0 1 1 1	abs16	abs16	1 1 1 1

### [ Number of Bytes/Number of Cycles ]

dest	Rn	An	[An]	dsp:8[An]	dsp:8[SB/FB]	dsp:16[An]	dsp:16[SB]	abs16
Bytes/Cycles	2/1+m	2/1+m	2/2+m	3/2+m	3/2+m	4/2+m	4/2+m	4/2+m

- m denotes the number of bits to be shifted.

# SHL

## (2) SHL.size R1H, dest

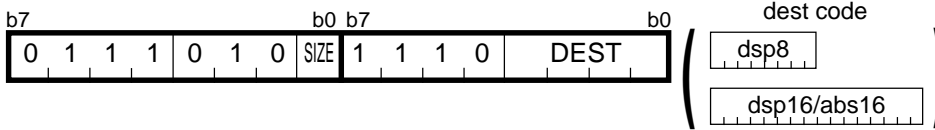

.size	SIZE
.B	0
.W	1

		dest	DEST			dest	DEST
Rn	R0L/R0		0 0 0 0	dsp:8[An]	dsp:8[A0]	1 0 0 0	
	R0H/---		0 0 0 1		dsp:8[A1]	1 0 0 1	
	R1L/R2		0 0 1 0	dsp:8[SB/FB]	dsp:8[SB]	1 0 1 0	
	--- /R3		0 0 1 1		dsp:8[FB]	1 0 1 1	
An	A0		0 1 0 0	dsp:16[An]	dsp:16[A0]	1 1 0 0	
	A1		0 1 0 1		dsp:16[A1]	1 1 0 1	
[An]	[A0]		0 1 1 0	dsp:16[SB]	dsp:16[SB]	1 1 1 0	
	[A1]		0 1 1 1	abs16	abs16	1 1 1 1	

- Items marked --- cannot be selected.

### [ Number of Bytes/Number of Cycles ]

dest	Rn	An	[An]	dsp:8[An]	dsp:8[SB/FB]	dsp:16[An]	dsp:16[SB]	abs16
Bytes/Cycles	2/2+m	2/2+m	2/3+m	3/3+m	3/3+m	4/3+m	4/3+m	4/3+m

- m denotes the number of bits to be shifted.

# SHL

## (3) SHL.L #IMM, dest

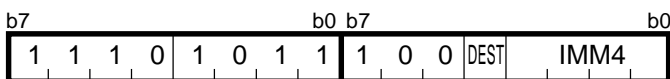

#IMM	IMM4	#IMM	IMM4
+1	0 0 0 0	-1	1 0 0 0
+2	0 0 0 1	-2	1 0 0 1
+3	0 0 1 0	-3	1 0 1 0
+4	0 0 1 1	-4	1 0 1 1
+5	0 1 0 0	-5	1 1 0 0
+6	0 1 0 1	-6	1 1 0 1
+7	0 1 1 0	-7	1 1 1 0
+8	0 1 1 1	-8	1 1 1 1

dest	DEST
R2R0	0
R3R1	1

### [ Number of Bytes/Number of Cycles ]

Bytes/Cycles	2/3+m
--------------	-------

- m denotes the number of bits to be shifted.

## SHL

(4) SHL.L R1H, dest

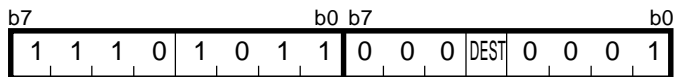

dest	DEST
R2R0	0
R3R1	1

[ Number of Bytes/Number of Cycles ]

Bytes/Cycles	2/4+m
--------------	-------

- m denotes the number of bits to be shifted.

## SMOVB

(1) SMOVB.size

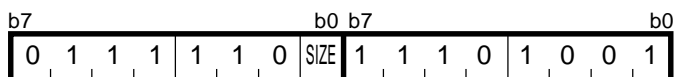

.size	SIZE
.B	0
.W	1

[ Number of Bytes/Number of Cycles ]

Bytes/Cycles	2/5+5×m
--------------	---------

- m denotes the number of transfers to be performed.

# SMOVF

## (1) SMOVF.size

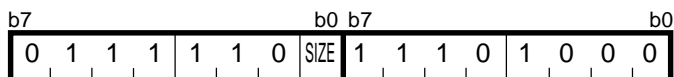

.size	SIZE
.B	0
.W	1

### [ Number of Bytes/Number of Cycles ]

Bytes/Cycles	$2/5+5 \times m$
--------------	------------------

- m denotes the number of transfers to be performed.

# SSTR

## (1) SSTR.size

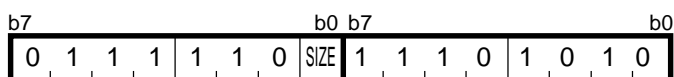

.size	SIZE
.B	0
.W	1

### [ Number of Bytes/Number of Cycles ]

Bytes/Cycles	$2/3+2 \times m$
--------------	------------------

- m denotes the number of transfers to be performed.

# STC

## (1) STC src, dest

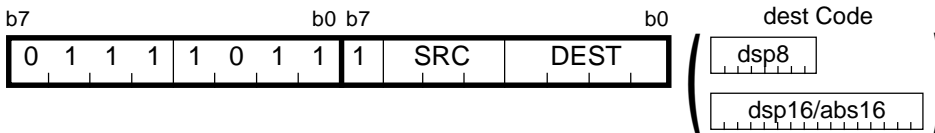

src	SRC
---	0 0 0
INTBL	0 0 1
INTBH	0 1 0
FLG	0 1 1
ISP	1 0 0
SP	1 0 1
SB	1 1 0
FB	1 1 1

dest		DEST	dest		DEST
Rn	R0	0 0 0 0	dsp:8[An]	dsp:8[A0]	1 0 0 0
	R1	0 0 0 1		dsp:8[A1]	1 0 0 1
	R2	0 0 1 0	dsp:8[SB/FB]	dsp:8[SB]	1 0 1 0
	R3	0 0 1 1		dsp:8[FB]	1 0 1 1
An	A0	0 1 0 0	dsp:16[An]	dsp:16[A0]	1 1 0 0
	A1	0 1 0 1		dsp:16[A1]	1 1 0 1
[An]	[A0]	0 1 1 0	dsp:16[SB]	dsp:16[SB]	1 1 1 0
	[A1]	0 1 1 1	abs16	abs16	1 1 1 1

- Items marked --- cannot be selected.

### [ Number of Bytes/Number of Cycles ]

dest	Rn	An	[An]	dsp:8[An]	dsp:8[SB/FB]	dsp:16[An]	dsp:16[SB]	abs16
Bytes/Cycles	2/1	2/1	2/2	3/2	3/2	4/2	4/2	4/2

# STC

## (2) STC PC, dest

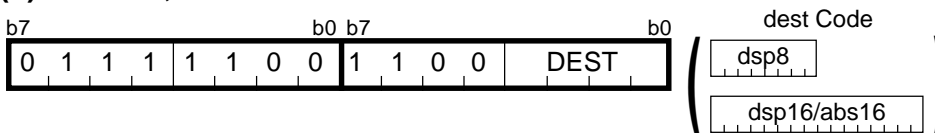

dest		DEST	dest		DEST
Rn	R2R0	0 0 0 0	dsp:8[An]	dsp:8[A0]	1 0 0 0
	R3R1	0 0 0 1		dsp:8[A1]	1 0 0 1
	---	0 0 1 0	dsp:8[SB/FB]	dsp:8[SB]	1 0 1 0
	---	0 0 1 1		dsp:8[FB]	1 0 1 1
An	A1A0	0 1 0 0	dsp:16[An]	dsp:16[A0]	1 1 0 0
	---	0 1 0 1		dsp:16[A1]	1 1 0 1
[An]	[A0]	0 1 1 0	dsp:16[SB]	dsp:16[SB]	1 1 1 0
	[A1]	0 1 1 1	abs16	abs16	1 1 1 1

- Items marked --- cannot be selected.

### [ Number of Bytes/Number of Cycles ]

dest	Rn	An	[An]	dsp:8[An]	dsp:8[SB/FB]	dsp:16[An]	dsp:16[SB]	abs16
Bytes/Cycles	2/2	2/2	2/3	3/3	3/3	4/3	4/3	4/3

# STCTX

## (1) STCTX abs16, abs20

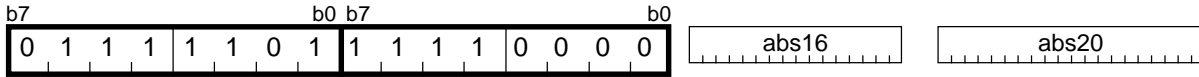

[ Number of Bytes/Number of Cycles ]

Bytes/Cycles	7/11+2×m
--------------	----------

- m denotes the number of transfers to be performed.

# STE

## (1) STE.size src, abs20

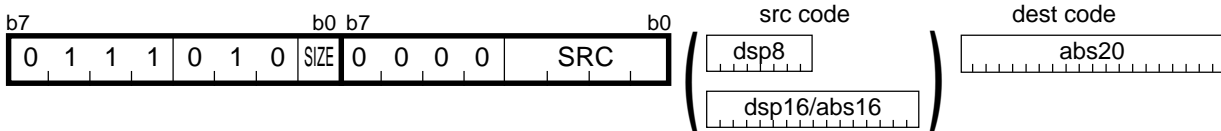

.size	SIZE
.B	0
.W	1

		src	SRC			src	SRC
Rn	R0L/R0		0 0 0 0	dsp:8[An]	dsp:8[A0]	1 0 0 0	
	R0H/R1		0 0 0 1		dsp:8[A1]	1 0 0 1	
	R1L/R2		0 0 1 0	dsp:8[SB/FB]	dsp:8[SB]	1 0 1 0	
	R1H/R3		0 0 1 1		dsp:8[FB]	1 0 1 1	
An	A0		0 1 0 0	dsp:16[An]	dsp:16[A0]	1 1 0 0	
	A1		0 1 0 1		dsp:16[A1]	1 1 0 1	
[An]	[A0]		0 1 1 0	dsp:16[SB]	dsp:16[SB]	1 1 1 0	
	[A1]		0 1 1 1	abs16	abs16	1 1 1 1	

[ Number of Bytes/Number of Cycles ]

src	Rn	An	[An]	dsp:8[An]	dsp:8[SB/FB]	dsp:16[An]	dsp:16[SB]	abs16
Bytes/Cycles	5/3	5/3	5/4	6/4	6/4	7/4	7/4	7/4

## STE

### (2) STE.size src, dsp:20[A0]

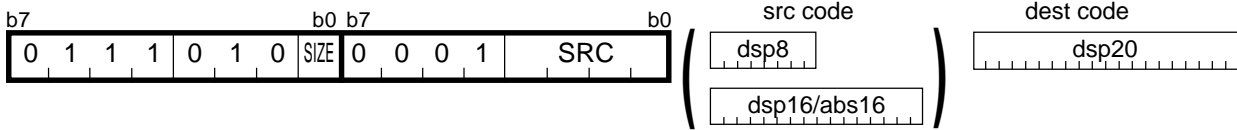

.size	SIZE
.B	0
.W	1

		src	SRC			src	SRC
Rn	R0L/R0		0 0 0 0	dsp:8[An]	dsp:8[A0]		1 0 0 0
	R0H/R1		0 0 0 1		dsp:8[A1]		1 0 0 1
	R1L/R2		0 0 1 0	dsp:8[SB/FB]	dsp:8[SB]		1 0 1 0
	R1H/R3		0 0 1 1		dsp:8[FB]		1 0 1 1
An	A0		0 1 0 0	dsp:16[An]	dsp:16[A0]		1 1 0 0
	A1		0 1 0 1		dsp:16[A1]		1 1 0 1
[An]	[A0]		0 1 1 0	dsp:16[SB]	dsp:16[SB]		1 1 1 0
	[A1]		0 1 1 1	abs16	abs16		1 1 1 1

#### [ Number of Bytes/Number of Cycles ]

src	Rn	An	[An]	dsp:8[An]	dsp:8[SB/FB]	dsp:16[An]	dsp:16[SB]	abs16
Bytes/Cycles	5/3	5/3	5/4	6/4	6/4	7/4	7/4	7/4

## STE

### (3) STE.size src, [A1A0]

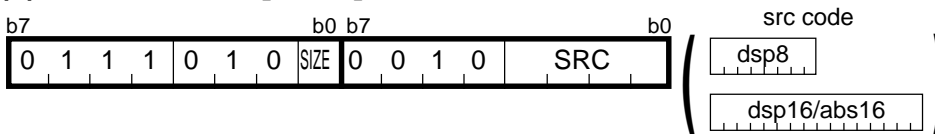

.size	SIZE
.B	0
.W	1

		src	SRC			src	SRC
Rn	R0L/R0		0 0 0 0	dsp:8[An]	dsp:8[A0]		1 0 0 0
	R0H/R1		0 0 0 1		dsp:8[A1]		1 0 0 1
	R1L/R2		0 0 1 0	dsp:8[SB/FB]	dsp:8[SB]		1 0 1 0
	R1H/R3		0 0 1 1		dsp:8[FB]		1 0 1 1
An	A0		0 1 0 0	dsp:16[An]	dsp:16[A0]		1 1 0 0
	A1		0 1 0 1		dsp:16[A1]		1 1 0 1
[An]	[A0]		0 1 1 0	dsp:16[SB]	dsp:16[SB]		1 1 1 0
	[A1]		0 1 1 1	abs16	abs16		1 1 1 1

#### [ Number of Bytes/Number of Cycles ]

src	Rn	An	[An]	dsp:8[An]	dsp:8[SB/FB]	dsp:16[An]	dsp:16[SB]	abs16
Bytes/Cycles	2/3	2/3	2/4	3/4	3/4	4/4	4/4	4/4

# STNZ

**(1) STNZ #IMM8, dest**

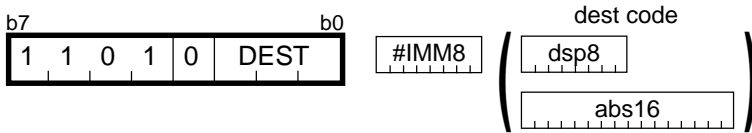

dest		DEST
Rn	R0H	0 1 1
	R0L	1 0 0
dsp:8[SB/FB]	dsp:8[SB]	1 0 1
	dsp:8[FB]	1 1 0
abs16	abs16	1 1 1

**[ Number of Bytes/Number of Cycles ]**

dest	Rn	dsp:8[SB/FB]	abs16
Bytes/Cycles	2/1	3/2	4/2

- If the Z flag = 0, the number of cycles indicated is increased by 1.

# STZ

**(1) STZ #IMM8, dest**

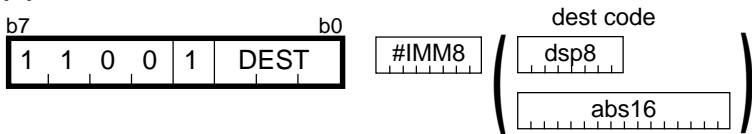

dest		DEST
Rn	R0H	0 1 1
	R0L	1 0 0
dsp:8[SB/FB]	dsp:8[SB]	1 0 1
	dsp:8[FB]	1 1 0
abs16	abs16	1 1 1

**[ Number of Bytes/Number of Cycles ]**

dest	Rn	dsp:8[SB/FB]	abs16
Bytes/Cycles	2/1	3/2	4/2

- If the Z flag = 1, the number of cycles indicated is increased by 1.

# STZX

(1) STZX #IMM81, #IMM82, dest

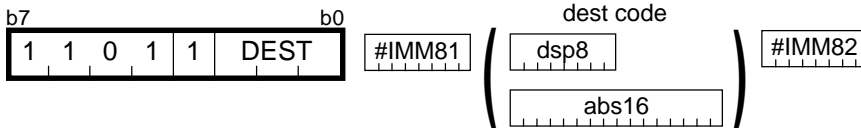

dest		DEST
Rn	R0H	0 1 1
	R0L	1 0 0
dsp:8[SB/FB]	dsp:8[SB]	1 0 1
	dsp:8[FB]	1 1 0
abs16	abs16	1 1 1

[ Number of Bytes/Number of Cycles ]

dest	Rn	dsp:8[SB/FB]	abs16
Bytes/Cycles	3/2	4/3	5/3

# SUB

(1) SUB.size:G #IMM, dest

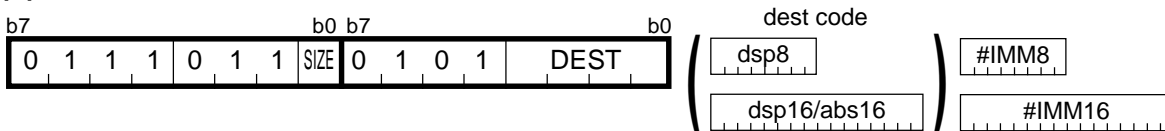

.size	SIZE
.B	0
.W	1

dest		DEST	dest		DEST	
Rn	R0L/R0	0 0 0 0	dsp:8[An]	dsp:8[A0]	1 0 0 0	
	R0H/R1	0 0 0 1		dsp:8[A1]	1 0 0 1	
	R1L/R2	0 0 1 0		dsp:8[SB/FB]	dsp:8[SB]	1 0 1 0
	R1H/R3	0 0 1 1			dsp:8[FB]	1 0 1 1
An	A0	0 1 0 0	dsp:16[An]	dsp:16[A0]	1 1 0 0	
	A1	0 1 0 1		dsp:16[A1]	1 1 0 1	
[An]	[A0]	0 1 1 0	dsp:16[SB]	dsp:16[SB]	1 1 1 0	
	[A1]	0 1 1 1	abs16	abs16	1 1 1 1	

[ Number of Bytes/Number of Cycles ]

dest	Rn	An	[An]	dsp:8[An]	dsp:8[SB/FB]	dsp:16[An]	dsp:16[SB]	abs16
Bytes/Cycles	3/2	3/2	3/4	4/4	4/4	5/4	5/4	5/4

- If the size specifier (.size) is (.W), the number of bytes indicated is increased by 1.

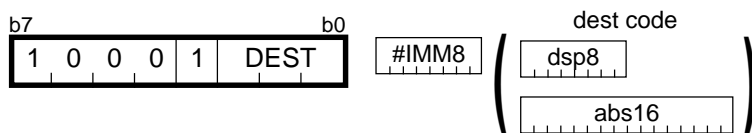
**SUB****(2) SUB.B:S #IMM8, dest**

dest		DEST
Rn	R0H	0 1 1
	R0L	1 0 0
dsp:8[SB/FB]	dsp:8[SB]	1 0 1
	dsp:8[FB]	1 1 0
abs16	abs16	1 1 1

**[ Number of Bytes/Number of Cycles ]**

dest	Rn	dsp:8[SB/FB]	abs16
Bytes/Cycles	2/1	3/3	4/3

# SUB

(3) SUB.size:G src, dest

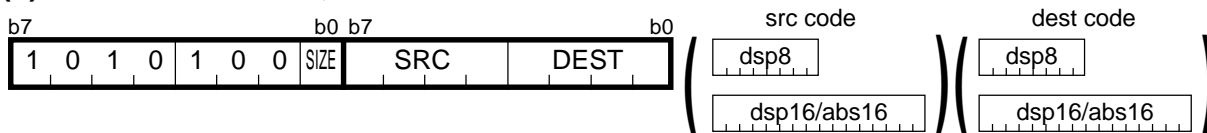

.size	SIZE
.B	0
.W	1

src/dest		SRC/DEST	src/dest		SRC/DEST
Rn	R0L/R0	0 0 0 0	dsp:8[An]	dsp:8[A0]	1 0 0 0
	R0H/R1	0 0 0 1		dsp:8[A1]	1 0 0 1
	R1L/R2	0 0 1 0	dsp:8[SB/FB]	dsp:8[SB]	1 0 1 0
	R1H/R3	0 0 1 1		dsp:8[FB]	1 0 1 1
An	A0	0 1 0 0	dsp:16[An]	dsp:16[A0]	1 1 0 0
	A1	0 1 0 1		dsp:16[A1]	1 1 0 1
[An]	[A0]	0 1 1 0	dsp:16[SB]	dsp:16[SB]	1 1 1 0
	[A1]	0 1 1 1	abs16	abs16	1 1 1 1

[ Number of Bytes/Number of Cycles ]

src \ dest	Rn	An	[An]	dsp:8[An]	dsp:8[SB/FB]	dsp:16[An]	dsp:16[SB]	abs16
Rn	2/2	2/2	2/3	3/3	3/3	4/3	4/3	4/3
An	2/2	2/2	2/3	3/3	3/3	4/3	4/3	4/3
[An]	2/3	2/3	2/4	3/4	3/4	4/4	4/4	4/4
dsp:8[An]	3/3	3/3	3/4	4/4	4/4	5/4	5/4	5/4
dsp:8[SB/FB]	3/3	3/3	3/4	4/4	4/4	5/4	5/4	5/4
dsp:16[An]	4/3	4/3	4/4	5/4	5/4	6/4	6/4	6/4
dsp:16[SB]	4/3	4/3	4/4	5/4	5/4	6/4	6/4	6/4
abs16	4/3	4/3	4/4	5/4	5/4	6/4	6/4	6/4

# SUB

## (4) SUB.B:S src, R0L/R0H

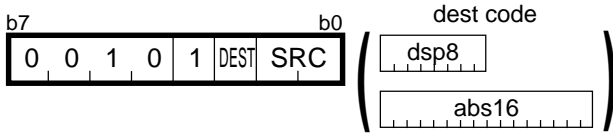

src		SRC
Rn	R0L/R0H	0 0
dsp:8[SB/FB]	dsp:8[SB]	0 1
	dsp:8[FB]	1 0
abs16	abs16	1 1

dest	DEST
R0L	0
R0H	1

### [ Number of Bytes/Number of Cycles ]

src	Rn	dsp:8[SB/FB]	abs16
Bytes/Cycles	1/2	2/3	3/3

# TST

## (1) TST.size #IMM, dest

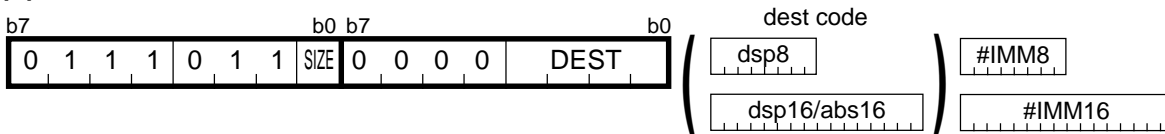

.size	SIZE
.B	0
.W	1

dest		DEST	dest		DEST	
Rn	R0L/R0	0 0 0 0	dsp:8[An]	dsp:8[A0]	1 0 0 0	
	R0H/R1	0 0 0 1		dsp:8[A1]	1 0 0 1	
	R1L/R2	0 0 1 0		dsp:8[SB/FB]	dsp:8[SB]	1 0 1 0
	R1H/R3	0 0 1 1			dsp:8[FB]	1 0 1 1
An	A0	0 1 0 0	dsp:16[An]	dsp:16[A0]	1 1 0 0	
	A1	0 1 0 1		dsp:16[A1]	1 1 0 1	
[An]	[A0]	0 1 1 0	dsp:16[SB]	dsp:16[SB]	1 1 1 0	
	[A1]	0 1 1 1	abs16	abs16	1 1 1 1	

### [ Number of Bytes/Number of Cycles ]

dest	Rn	An	[An]	dsp:8[An]	dsp:8[SB/FB]	dsp:16[An]	dsp:16[SB]	abs16
Bytes/Cycles	3/2	3/2	3/4	4/4	4/4	5/4	5/4	5/4

- If the size specifier (.size) is (.W), the number of bytes indicated is increased by 1.

# TST

## (2) TST.size src, dest

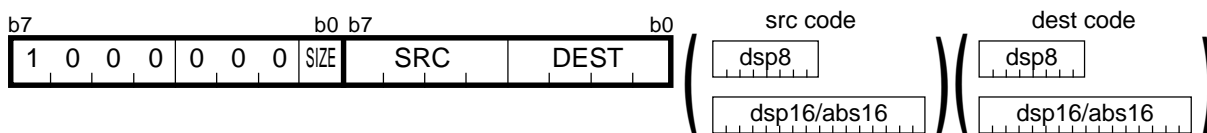

.size	SIZE
.B	0
.W	1

src/dest		SRC/DEST	src/dest		SRC/DEST
Rn	R0L/R0	0 0 0 0	dsp:8[An]	dsp:8[A0]	1 0 0 0
	R0H/R1	0 0 0 1		dsp:8[A1]	1 0 0 1
	R1L/R2	0 0 1 0	dsp:8[SB/FB]	dsp:8[SB]	1 0 1 0
	R1H/R3	0 0 1 1		dsp:8[FB]	1 0 1 1
An	A0	0 1 0 0	dsp:16[An]	dsp:16[A0]	1 1 0 0
	A1	0 1 0 1		dsp:16[A1]	1 1 0 1
[An]	[A0]	0 1 1 0	dsp:16[SB]	dsp:16[SB]	1 1 1 0
	[A1]	0 1 1 1	abs16	abs16	1 1 1 1

### [ Number of Bytes/Number of Cycles ]

src \ dest	Rn	An	[An]	dsp:8[An]	dsp:8[SB/FB]	dsp:16[An]	dsp:16[SB]	abs16
Rn	2/2	2/2	2/3	3/3	3/3	4/3	4/3	4/3
An	2/2	2/2	2/3	3/3	3/3	4/3	4/3	4/3
[An]	2/3	2/3	2/4	3/4	3/4	4/4	4/4	4/4
dsp:8[An]	3/3	3/3	3/4	4/4	4/4	5/4	5/4	5/4
dsp:8[SB/FB]	3/3	3/3	3/4	4/4	4/4	5/4	5/4	5/4
dsp:16[An]	4/3	4/3	4/4	5/4	5/4	6/4	6/4	6/4
dsp:16[SB]	4/3	4/3	4/4	5/4	5/4	6/4	6/4	6/4
abs16	4/3	4/3	4/4	5/4	5/4	6/4	6/4	6/4

# UND

## (1) UND

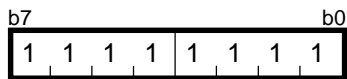

[ Number of Bytes/Number of Cycles ]

Bytes/Cycles	1/20
--------------	------

# WAIT

## (1) WAIT

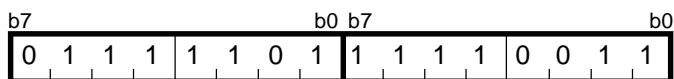

[ Number of Bytes/Number of Cycles ]

Bytes/Cycles	2/3
--------------	-----

# XCHG

## (1) XCHG.size src, dest

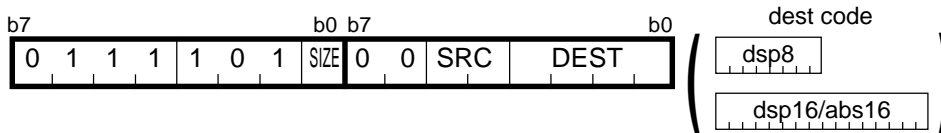

.size	SIZE
.B	0
.W	1

src	SRC
R0L/R0	0 0
R0H/R1	0 1
R1L/R2	1 0
R1H/R3	1 1

dest		DEST	dest		DEST
Rn	R0L/R0	0 0 0 0	dsp:8[An]	dsp:8[A0]	1 0 0 0
	R0H/R1	0 0 0 1		dsp:8[A1]	1 0 0 1
	R1L/R2	0 0 1 0	dsp:8[SB/FB]	dsp:8[SB]	1 0 1 0
	R1H/R3	0 0 1 1		dsp:8[FB]	1 0 1 1
An	A0	0 1 0 0	dsp:16[An]	dsp:16[A0]	1 1 0 0
	A1	0 1 0 1		dsp:16[A1]	1 1 0 1
[An]	[A0]	0 1 1 0	dsp:16[SB]	dsp:16[SB]	1 1 1 0
	[A1]	0 1 1 1	abs16	abs16	1 1 1 1

### [ Number of Bytes/Number of Cycles ]

dest	Rn	An	[An]	dsp:8[An]	dsp:8[SB/FB]	dsp:16[An]	dsp:16[SB]	abs16
Bytes/Cycles	2/4	2/4	2/5	3/5	3/5	4/5	4/5	4/5

# XOR

## (1) XOR.size #IMM, dest

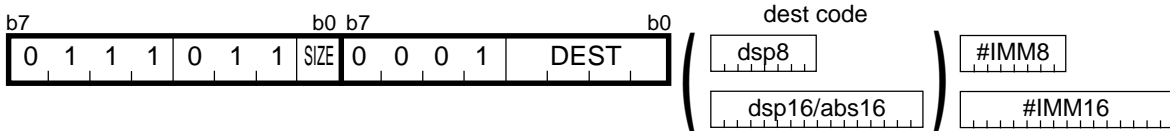

.size	SIZE
.B	0
.W	1

dest		DEST	dest		DEST
Rn	R0L/R0	0 0 0 0	dsp:8[An]	dsp:8[A0]	1 0 0 0
	R0H/R1	0 0 0 1		dsp:8[A1]	1 0 0 1
	R1L/R2	0 0 1 0	dsp:8[SB/FB]	dsp:8[SB]	1 0 1 0
	R1H/R3	0 0 1 1		dsp:8[FB]	1 0 1 1
An	A0	0 1 0 0	dsp:16[An]	dsp:16[A0]	1 1 0 0
	A1	0 1 0 1		dsp:16[A1]	1 1 0 1
[An]	[A0]	0 1 1 0	dsp:16[SB]	dsp:16[SB]	1 1 1 0
	[A1]	0 1 1 1	abs16	abs16	1 1 1 1

### [ Number of Bytes/Number of Cycles ]

dest	Rn	An	[An]	dsp:8[An]	dsp:8[SB/FB]	dsp:16[An]	dsp:16[SB]	abs16
Bytes/Cycles	3/2	3/2	3/4	4/4	4/4	5/4	5/4	5/4

- If the size specifier (.size) is (.W), the number of bytes indicated is increased by 1.

# XOR

## (2) XOR.size src, dest

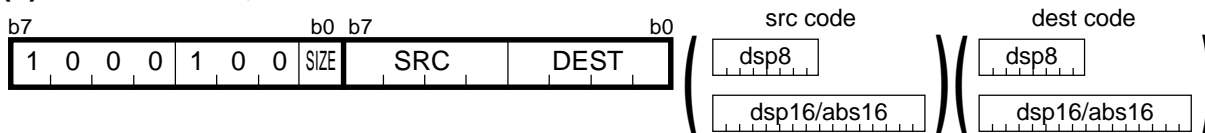

.size	SIZE
.B	0
.W	1

src/dest		SRC/DEST	src/dest		SRC/DEST
Rn	R0L/R0	0 0 0 0	dsp:8[An]	dsp:8[A0]	1 0 0 0
	R0H/R1	0 0 0 1		dsp:8[A1]	1 0 0 1
	R1L/R2	0 0 1 0	dsp:8[SB/FB]	dsp:8[SB]	1 0 1 0
	R1H/R3	0 0 1 1		dsp:8[FB]	1 0 1 1
An	A0	0 1 0 0	dsp:16[An]	dsp:16[A0]	1 1 0 0
	A1	0 1 0 1		dsp:16[A1]	1 1 0 1
[An]	[A0]	0 1 1 0	dsp:16[SB]	dsp:16[SB]	1 1 1 0
	[A1]	0 1 1 1	abs16	abs16	1 1 1 1

### [ Number of Bytes/Number of Cycles ]

src \ dest	Rn	An	[An]	dsp:8[An]	dsp:8[SB/FB]	dsp:16[An]	dsp:16[SB]	abs16
Rn	2/2	2/2	2/3	3/3	3/3	4/3	4/3	4/3
An	2/2	2/2	2/3	3/3	3/3	4/3	4/3	4/3
[An]	2/3	2/3	2/4	3/4	3/4	4/4	4/4	4/4
dsp:8[An]	3/3	3/3	3/4	4/4	4/4	5/4	5/4	5/4
dsp:8[SB/FB]	3/3	3/3	3/4	4/4	4/4	5/4	5/4	5/4
dsp:16[An]	4/3	4/3	4/4	5/4	5/4	6/4	6/4	6/4
dsp:16[SB]	4/3	4/3	4/4	5/4	5/4	6/4	6/4	6/4
abs16	4/3	4/3	4/4	5/4	5/4	6/4	6/4	6/4

# Chapter 5

---

## Interrupts

- 5.1 Outline of Interrupts
- 5.2 Interrupt Control
- 5.3 Interrupt Sequence
- 5.4 Returning from Interrupt Routines
- 5.5 Interrupt Priority
- 5.6 Multiple Interrupts
- 5.7 Notes on Interrupts

## 5.1 Outline of Interrupts

When an interrupt request is acknowledged, control branches to the interrupt routine that is set in an interrupt vector table. Each interrupt vector table must have had the start address of its corresponding interrupt routine set. For details about interrupt vector tables, refer to section 1.10, “Vector Tables”.

### 5.1.1 Types of Interrupts

Figure 5.1.1 lists the types of interrupts. Table 5.1.1 lists the source of interrupts (nonmaskable) and the fixed vector tables.

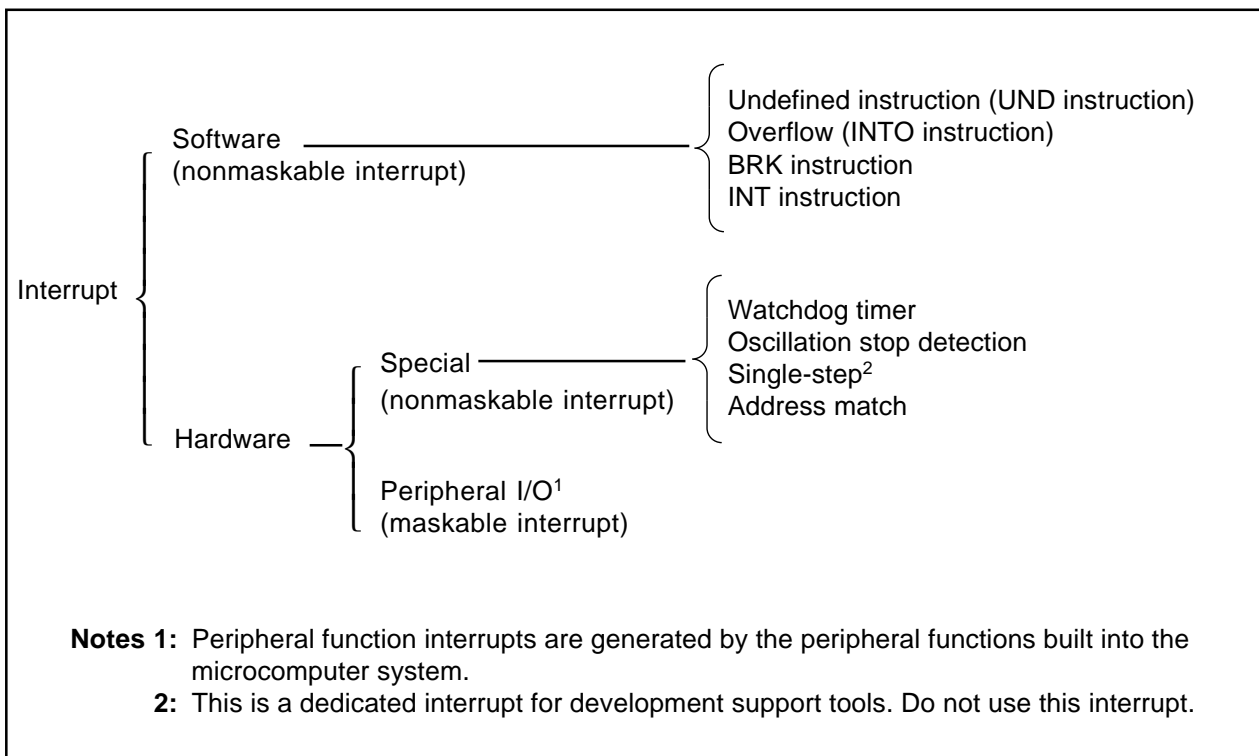

Figure 5.1.1 Classification of Interrupts

- Maskable interrupt: This type of interrupt **can** be controlled by using the I flag to enable (or disable) the interrupts or by changing the interrupt priority level.
- Nonmaskable interrupt: This type of interrupt **cannot** be controlled by using the I flag to enable (or disable) the interrupts or by changing the interrupt priority level.

Table 5.1.1 Interrupt Sources (Nonmaskable) and Fixed Vector Tables

Interrupt Source	Vector Table Addresses Address (L) to Address (H)	Description
Undefined Instruction	0FFDC <sub>16</sub> to 0FFDF <sub>16</sub>	Interrupt generated by the UND instruction.
Overflow	0FFE0 <sub>16</sub> to 0FFE3 <sub>16</sub>	Interrupt generated by the INTO instruction.
BRK Instruction	0FFE4 <sub>16</sub> to 0FFE7 <sub>16</sub>	Executed beginning from address indicated by vector in variable vector table if 0FFE7 <sub>16</sub> address contents are FF <sub>16</sub> .
Address Match	0FFE8 <sub>16</sub> to 0FFEB <sub>16</sub>	Can be controlled by an interrupt enable bit.
Single Step <sup>1</sup>	0FFEC <sub>16</sub> to 0FFEF <sub>16</sub>	Do not use this interrupt.
Watchdog Timer•Oscillation Stop Detection	0FFF0 <sub>16</sub> to 0FFF3 <sub>16</sub>	
(Reserved)	0FFF4 <sub>16</sub> to 0FFF7 <sub>16</sub>	
(Reserved)	0FFF8 <sub>16</sub> to 0FFFB <sub>16</sub>	
Reset	0FFFC <sub>16</sub> to 0FFFF <sub>16</sub>	

**Note 1:** This is a dedicated interrupt used by development support tools. Do not use this interrupt.

### 5.1.2 Software Interrupts

Software interrupts are generated by an instruction that generates an interrupt request when executed. Software interrupts are nonmaskable.

#### ●Undefined-instruction interrupt

This interrupt occurs when the UND instruction is executed.

#### ●Overflow interrupt

This interrupt occurs if the INTO instruction is executed when the O flag is set to 1 (arithmetic result is overflow).

The instructions that cause the O flag to change are as follows: ABS, ADC, ADCF, ADD, CMP, DIV, DIVU, DIVX, NEG, RMPA, SBB, SHA, SUB.

#### ●BRK interrupt

This interrupt occurs when the BRK instruction is executed.

#### ●INT instruction interrupt

This interrupt occurs when the INT instruction is executed. The software interrupt numbers which can be specified by the INT instruction are 0 to 63. Note that software interrupt numbers 4 to 31 are assigned to peripheral function interrupts. This means that it is possible to execute the same interrupt routines used by peripheral function interrupts by executing the INT instruction.

For software interrupt numbers 0 to 31, the U flag is saved when the INT instruction is executed and the U flag is cleared to 0 to choose the interrupt stack pointer (ISP) before executing the interrupt sequence. The U flag before the interrupt occurred is restored when control returns from the interrupt routine. For software interrupt numbers 32 to 63, when the instruction is executed, the U flag does not change and the SP selected at the time is used.

### 5.1.3 Hardware Interrupts

There are two types in hardware interrupts: special interrupts and peripheral function interrupts.

#### ●Special interrupts

Special interrupts are nonmaskable.

##### (1) Watchdog timer interrupt

This interrupt is caused by the watchdog timer. Initialize the watchdog timer after the watchdog timer interrupt is generated. For details about the watchdog timer, refer to the R8C's hardware manual.

##### (2) Oscillation stop detection interrupt

This interrupt is caused by the oscillation stop detection function. For details about the oscillation stop detection function, refer to the R8C's hardware manual.

##### (3) Single-step interrupt

This interrupt is used exclusively by development support tools. Do not use this interrupt.

##### (4) Address-match interrupt

When the AIER0 or AIER1 bit in the AIER register is set to 1 (address-match interrupt enabled), the address-match interrupt is generated just before executing the instruction of the address indicated by the corresponding RMAD0 to RMAD1 register.

#### ●Peripheral function interrupts

These interrupts are generated by the peripheral functions built into the microcomputer. Peripheral function interrupts are maskable.

The types of built-in peripheral functions vary with each R8C model, as do the interrupt sources. For details about peripheral function interrupts, refer to the R8C's hardware manual.

## 5.2 Interrupt Control

This section explains how to enable/disable maskable interrupts and set acknowledge priority. The explanation here does not apply to non-maskable interrupts.

Maskable interrupts are enabled and disabled by using the I flag, IPL, and bits ILVL2 to ILVL0 in each interrupt control register. Whether or not an interrupt is requested is indicated by the IR bit in each interrupt control register.

For details about the memory allocation and the configuration of interrupt control registers, refer to the R8C's hardware manual.

### 5.2.1 I Flag

The I flag is used to disable/enable maskable interrupts. When the I flag is set to 1 (enabled), all maskable interrupts are enabled; when the I flag is cleared to 0 (disabled), they are disabled.

When the I flag is changed, the altered flag status is reflected in determining whether or not to accept an interrupt request with the following timing:

- If the flag is changed by an REIT instruction, the changed status takes effect beginning with the REIT instruction.
- If the flag is changed by an FCLR, FSET, POPC, or LDC instruction, the changed status takes effect beginning with the next instruction.

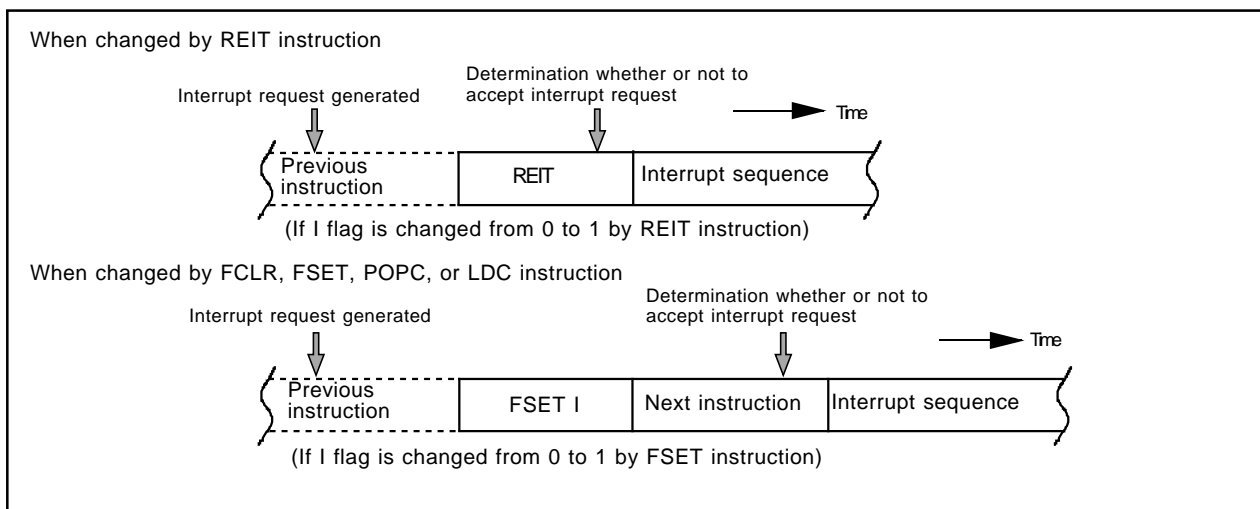

Figure 5.2.1 Timing with Which Changes of I Flag are Reflected in Interrupt Handling

### 5.2.2 IR Bit

The IR bit is set to 1 (interrupt requested) when an interrupt request is generated. The IR bit is cleared to 0 (interrupt not requested) after the interrupt request is acknowledged and the program branches to the corresponding interrupt vector.

The IR bit can be cleared to 0 by a program. Do not set it to 1.

### 5.2.3 ILVL2 to ILVL0 bits, IPL

Interrupt priority levels can be set using bits ILVL2 to ILVL0.

Table 5.2.1 shows how interrupt priority levels are set. Table 5.2.2 shows interrupt enable levels in relation to IPL.

The following lists the conditions under which an interrupt request is acknowledged:

- I flag = 1
- IR bit = 1
- Interrupt priority level > IPL

The I flag, bits ILVL2 to ILVL0, and IPL are independent of each other, and they do not affect each other.

Table 5.2.1 Interrupt Priority Levels

ILVL2–ILVL0	Interrupt Priority Level	Priority
0002	Level 0 (interrupt disabled)	——
0012	Level 1	Low  High
0102	Level 2	
0112	Level 3	
1002	Level 4	
1012	Level 5	
1102	Level 6	
1112	Level 7	

Table 5.2.2 Interrupt Priority Levels Enabled by IPL

IPL	Enabled interrupt priority levels
0002	Interrupt levels 1 and above are enabled.
0012	Interrupt levels 2 and above are enabled.
0102	Interrupt levels 3 and above are enabled.
0112	Interrupt levels 4 and above are enabled.
1002	Interrupt levels 5 and above are enabled.
1012	Interrupt levels 6 and above are enabled.
1102	Interrupt levels 7 and above are enabled.
1112	All maskable interrupts are disabled.

When the IPL or the interrupt priority level of an interrupt is changed, the altered level is reflected in interrupt handling with the following timing:

- If the IPL is changed by an REIT instruction, the new level takes effect beginning with the instruction that is executed two clock cycles after the last clock cycle of the REIT instruction.
- If the IPL is changed by a POPC, LDC, or LDIPL instruction, the new level takes effect beginning with the instruction that is executed three clock cycles after the last clock cycle of the instruction used.
- If the interrupt priority level of a particular interrupt is changed by an instruction such as MOV, the new level takes effect beginning with the instruction that is executed two or three clock cycles after the last clock cycle of the instruction used.

### 5.2.4 Changing Interrupt Control Registers

- (1) Individual interrupt control registers can only be modified while no interrupt requests corresponding to that register are generated. If interrupt requests managed by the interrupt control register are likely to occur, disable interrupts before changing the contents of the interrupt control register.
- (2) When modifying an interrupt control register after disabling interrupts, care must be taken when selecting the instructions to be used.

#### Changing Bits Other Than IR Bit

If an interrupt request corresponding to the register is generated while executing the instruction, the IR bit may not be set to 1 (interrupt requested), with the result that the interrupt request is ignored. To get around this problem, use the following instructions to modify the register: AND, OR, BCLR, BSET.

#### Changing IR Bit

Even when the IR bit is cleared to 0 (interrupt not requested), it may not actually be cleared to 0 depending on the instruction used. Therefore, use the MOV instruction to set the IR bit to 0.

- (3) When disabling interrupts using the I flag, refer to the following sample programs. (Refer to (2) above regarding changing interrupt control registers in the sample programs.)

Sample programs 1 to 3 are to prevent the I flag from being set to 1 (interrupt enabled) before writing to the interrupt control registers depending on the state of the internal bus or the instruction queue buffer.

#### Example 1: Use NOP instruction to prevent I flag being set to 1 before interrupt control register is changed

```
INT_SWITCH1:
  FCLR   I           ; Disable interrupts
  AND.B  #00H, 0056H ; Set TXIC register to 0016
  NOP
  NOP
  FSET   I           ; Enable interrupts
```

#### Example 2: Use dummy read to delay FSET instruction

```
INT_SWITCH2:
  FCLR   I           ; Disable interrupts
  AND.B  #00H, 0056H ; Set TXIC register to 0016
  MOV.W  MEM, R0     ; Dummy read
  FSET   I           ; Enable interrupts
```

#### Example 3: Use POPC instruction to change I flag

```
INT_SWITCH3:
  PUSHC  FLG
  FCLR   I           ; Disable interrupts
  AND.B  #00H, 0056H ; Set TXIC register to 0016
  POPC   FLG        ; Enable interrupts
```

### 5.3 Interrupt Sequence

The interrupt sequence — the operations performed from the instant an interrupt is accepted to the instant the interrupt routine is executed — is described here.

If an interrupt occurs during execution of an instruction, the processor determines its priority when the execution of the instruction is completed and transfers control to the interrupt sequence from the next cycle. If an interrupt occurs during execution of the SMOVB, SMOVF, SSTR, or RMPA instruction, the processor temporarily suspends the instruction being executed and transfers control to the interrupt sequence.

In the interrupt sequence, the processor carries out the operations listed below. Figure 5.3.1 shows the interrupt sequence execution time.

- (1) The CPU obtains the interrupt information (the interrupt number and interrupt request level) by reading address 0000016. Then, the IR bit corresponding to the interrupt is set to 0 (interrupt not requested issued).
- (2) The FLG register is saved as it was immediately before the start of the interrupt sequence in a temporary register<sup>1</sup> within the CPU.
- (3) The I flag, the D flag, and the U flag in the FLG register are set as follows:
  - The I flag is cleared to 0 (interrupts disabled)
  - The D flag is cleared to 0 (single-step interrupt disabled)
  - The U flag is cleared to 0 (ISP specified)
 However, the U flag status does not change when the INT instruction for software interrupt numbers 32 to 63 is executed.
- (4) The contents of the temporary register<sup>1</sup> are saved within the CPU in the stack area.
- (5) The PC is saved in the stack area.
- (6) The interrupt priority level of the accepted instruction is set in IPL.
- (7) The first address of the interrupt routine set to the interrupt vector is set in the PC.

After the interrupt sequence is completed, the processor resumes executing instructions from the starting address of the interrupt routine.

Note 1: This register cannot be accessed by the user.

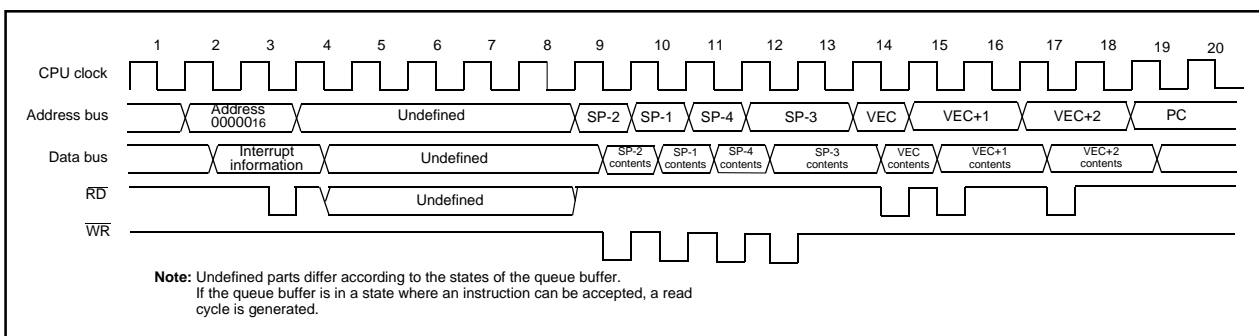

Figure 5.3.1 Interrupt Sequence Executing Time

### 5.3.1 Interrupt Response Time

Figure 5.3.2 shows the interrupt response time. The interrupt response time is the period from when an interrupt request is generated until the first instruction of the interrupt routine is executed. This period consists of the time ((a) in Figure 5.3.1) from when the interrupt request is generated to when the instruction then under way is completed and the time (20 cycles (b)) in which the interrupt sequence is executed.

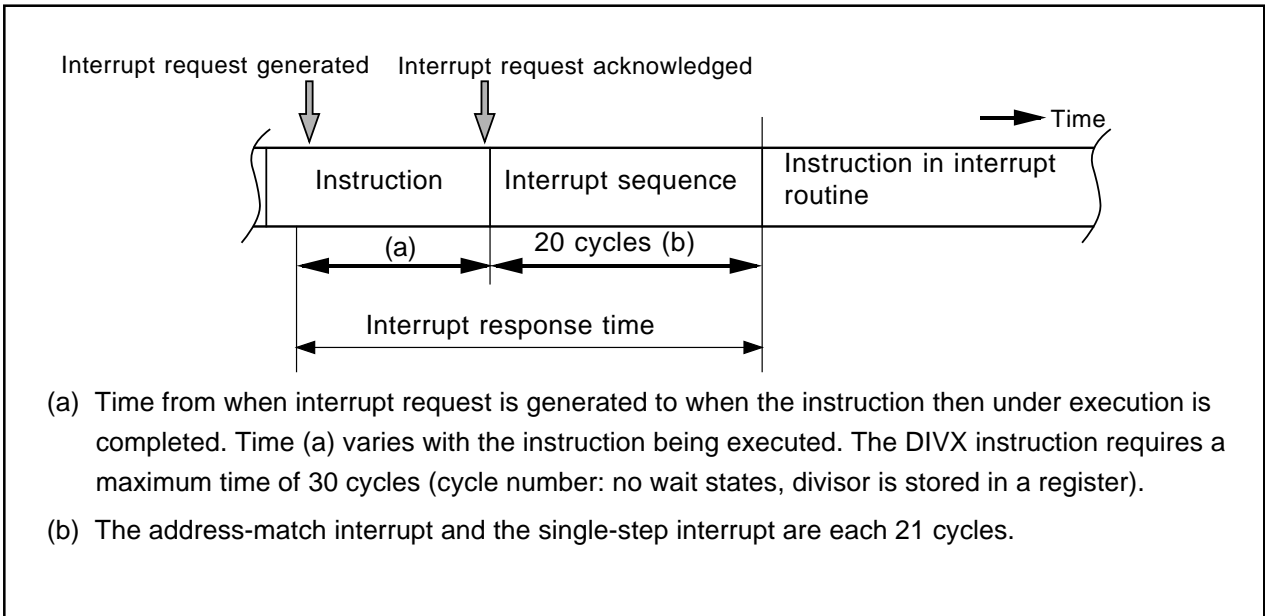

Figure 5.3.2 Interrupt Response Time

### 5.3.2 Changes of IPL when Interrupt Request Acknowledged

When an interrupt request of a maskable interrupt is acknowledged, the interrupt priority level of the acknowledged interrupt is set in IPL.

When a software interrupt request or a special interrupt request is acknowledged, the value shown in Table 5.3.1 is set in IPL. Table 5.3.1 shows the value of IPL when software interrupts and special interrupt requests are acknowledged.

Table 5.3.1 Value of IPL when Software Interrupt and Special Interrupt Request Acknowledged

Interrupt Sources Without Interrupt Priority Levels	Value that is set to IPL
Watchdog timer, oscillation stop detection	7
Software, address-match, single-step	Not changed

### 5.3.3 Saving Register Contents

In an interrupt sequence, the contents of the FLG register and the PC are saved to the stack area. The order in which these are saved is as follows. First, the 4 high-order bits of the PC and 4 high-order bits (IPL) and 8 low-order bits of the FLG register, a total of 16 bits, are saved to the stack area. Next, the 16 low-order bits of the PC are saved. Figure 5.3.3 shows the stack status before an interrupt request is acknowledged.

If there are any other registers to be saved, use a program to save them at the beginning of the interrupt routine. The PUSHM instruction can be used to save all registers, except SP, by a single instruction.

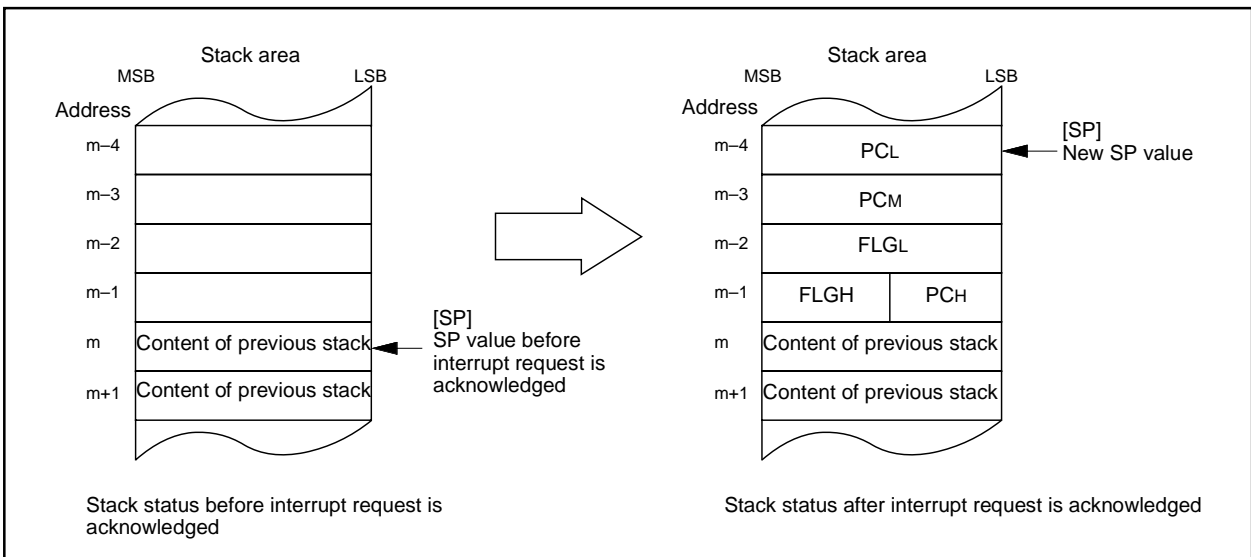

Figure 5.3.3 Stack Status Before and After an Interrupt Request is Acknowledged

The register save operations performed as part of an interrupt sequence are executed in four parts 8 bits at a time. Figure 5.3.4 shows the operations when saving register contents.

Note 1: When the INT instruction for software interrupt numbers 32 to 63 is executed, SP is indicated by the U flag. It is indicated by ISP in all other cases.

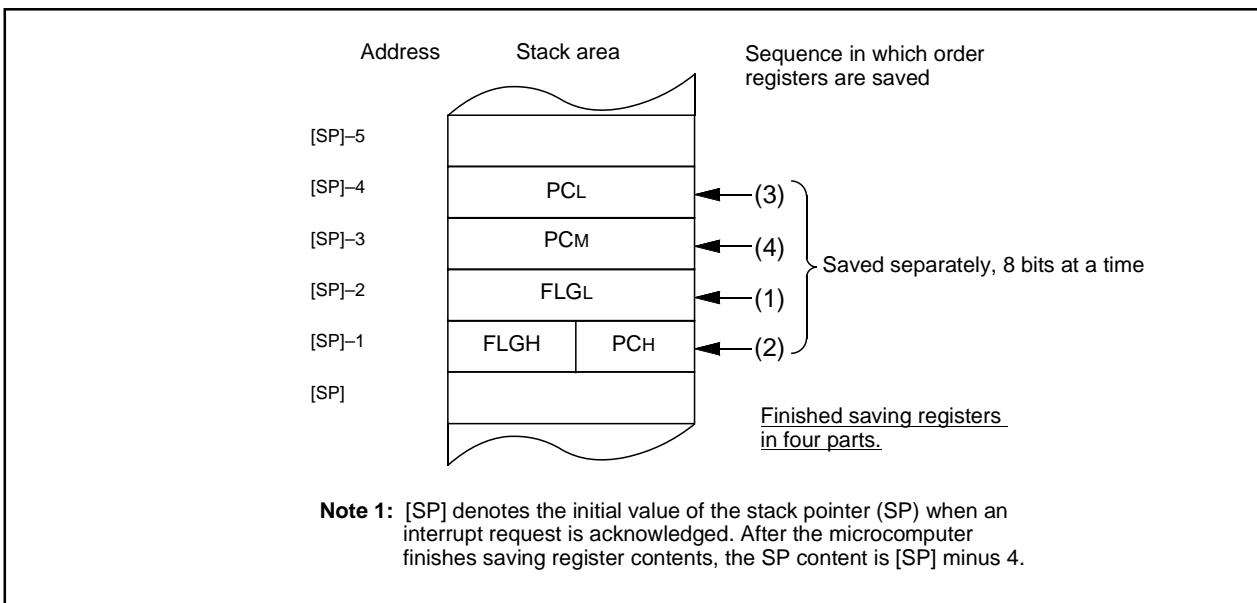

Figure 5.3.4 Operations when Saving Register Contents

## 5.4 Returning from Interrupt Routines

When the REIT instruction is executed at the end of the interrupt routine, the contents of the FLG register and PC that have been saved to the stack area immediately preceding the interrupt sequence are automatically restored. Then control returns to the routine that was under execution before the interrupt request was acknowledged.

If any registers were saved in the interrupt routine using a program, be sure to restore them using an instruction (e.g., the POPM instruction) before executing the REIT instruction.

## 5.5 Interrupt Priority

If two or more interrupt requests occur while a single instruction is being executed, the interrupt request that has higher priority is acknowledged.

The priority level of maskable interrupts (peripheral functions) can be selected arbitrarily by setting bits ILVL2 to ILVL0. If multiple maskable interrupts are assigned the same priority level, the priority that is set in hardware determines which is acknowledged.

Special interrupts such as the watchdog timer interrupt have their priority levels set in hardware. Figure 5.5.1 lists the interrupt priority levels of hardware interrupts.

Software interrupts are not affected by interrupt priority. They always cause control to branch to an interrupt routine when the relevant instruction is executed.

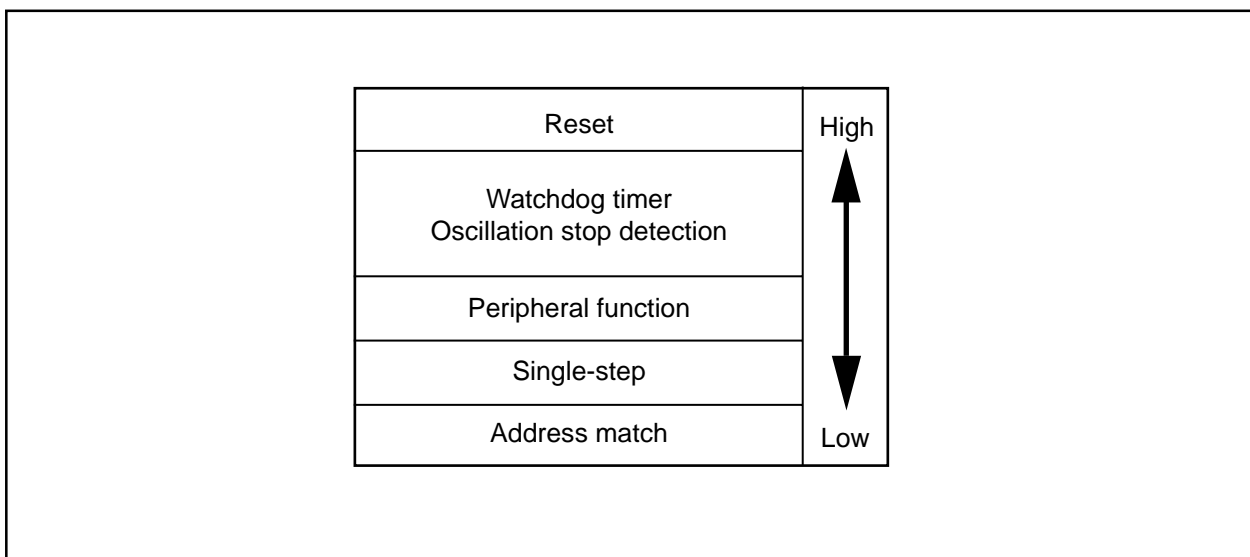

Figure 5.5.1 Interrupt Priority Levels of Hardware Interrupts

## 5.6 Multiple Interrupts

The internal bit states when control has branched to an interrupt routine are as follows:

- The interrupt enable flag (I flag) is cleared to 0 (interrupts disabled).
- The interrupt request bit for the acknowledged interrupt is cleared to 0.
- The processor interrupt priority level (IPL) equals the interrupt priority level of the acknowledged interrupt.

By setting the interrupt enable flag (I flag) to 1 in the interrupt routine, interrupts can be reenabled so that an interrupt request that has higher priority than the processor interrupt priority level (IPL) can be acknowledged. Figure 5.6.1 shows how multiple interrupts are handled.

Interrupt requests that have not been acknowledged due to low interrupt priority level are kept pending. When the IPL is restored by an REIT instruction and the interrupt priority is determined based on the IPL contents, the pending interrupt request is acknowledged if the following condition is met:

$$\text{Interrupt priority level of pending interrupt request} > \text{Restored processor interrupt priority level (IPL)}$$



## 5.7 Note on Interrupts

### 5.7.1 Reading Address 00000<sub>16</sub>

Avoid reading address 00000<sub>16</sub> in a program. When a maskable interrupt request is accepted, the CPU reads interrupt information (interrupt number and interrupt request priority level) from address 00000<sub>16</sub> during the interrupt sequence. At this time, the IR bit for the accepted interrupt is cleared to 0.

If address 00000<sub>16</sub> is read in a program, the IR bit for the interrupt which has the highest priority among the enabled interrupts is set to 0. This may cause the interrupt to be canceled or an unexpected interrupt to be generated.

### 5.7.2 SP Setting

Set a value in SP before accepting an interrupt. SP is set to 0000<sub>16</sub> after reset. Therefore, if an interrupt is accepted before setting a value in SP, the program may go out of control.

### 5.7.3 Changing Interrupt Control Register

(1) Individual interrupt control registers can only be modified while no interrupt requests corresponding to that register are generated. If interrupt requests managed by an interrupt control register are likely to occur, disable interrupts before changing the contents of the interrupt control register.

(2) When modifying an interrupt control register after disabling interrupts, care must be taken when selecting the instructions to be used.

#### Changing Bits Other Than IR Bit

If an interrupt request corresponding to the register is generated while executing the instruction, the IR bit may not be set to 1 (interrupt requested), with the result that the interrupt request is ignored. To get around this problem, use the following instructions to modify the register: AND, OR, BCLR, BSET.

#### When Changing IR Bit

Even when the IR bit is cleared to 0 (interrupt not requested), it may not actually be cleared to 0 depending on the instruction used. Therefore, use the MOV instruction to set the IR bit to 0.

(3) When disabling interrupts using the I flag, refer to the following sample programs. (Refer to (2) above regarding changing interrupt control registers in the sample programs.)

Sample programs 1 to 3 are to prevent the I flag from being set to 1 (interrupt enabled) before writing to the interrupt control registers depending on the state of the internal bus or the instruction queue buffer.

**Example 1: Use NOP instruction to prevent I flag being set to 1 before interrupt control register is changed**

```
INT_SWITCH1:
  FCLR  I           ; Disable interrupts
  AND.B #00H, 0056H ; Set TXIC register to 0016
  NOP
  NOP
  FSET  I           ; Enable interrupts
```

**Example 2: Use dummy read to delay FSET instruction**

```
INT_SWITCH2:
  FCLR  I           ; Disable interrupts
  AND.B #00H, 0056H ; Set TXIC register to 0016
  MOV.W MEM, R0     ; Dummy read
  FSET  I           ; Enable interrupts
```

**Example 3: Use POPC instruction to change I flag**

```
INT_SWITCH3:
  PUSHC FLG
  FCLR  I           ; Disable interrupts
  AND.B #00H, 0056H ; Set TXIC register to 0016
  POPC  FLG        ; Enable interrupts
```

## Chapter 6

---

# Calculating the Number of Cycles

### 6.1 Instruction Queue Buffer

## 6.1 Instruction Queue Buffer

R8C/Tiny Series microcomputers have 4-stage (4-byte) instruction queue buffers. If the instruction queue buffer has free space when the CPU can use the bus, instruction codes are taken into the instruction queue buffer. This is referred to as “prefetching”. The CPU reads (fetches) the instruction codes from the instruction queue buffer as it executes a program.

The explanation of the number of cycles in chapter 4 assumes that all the necessary instruction codes are placed in the instruction queue buffer, and that 8-bit data is read or written to the memory without software wait states. In the following cases, more cycles may be needed than the number of cycles indicated in this manual:

- If not all of the instruction codes needed by the CPU have been placed in the instruction queue buffer. Instruction codes are read in until all of the instruction codes required for program execution are available. Furthermore, the number of read cycles increases in the following case:
  - (1) The number of read cycles increases to match the number of wait cycles incurred when reading instruction codes from an area in which software wait cycles exist.
- When reading or writing data to an area in which software wait cycles exist. The number of read or write cycles increases to match the number of wait cycles incurred.
- When reading or writing 16-bit data from/to the SFR or the internal memory. The memory is accessed twice to read or write one 16-bit data item. Therefore, the number of read or write cycles increases by one for each 16-bit data item read or written.

Note that if prefetch and data access occur at the same time, data access has priority. Also, if more than three bytes of instruction codes exist in the instruction queue buffer, the CPU assumes there is no free space and, therefore, does not prefetch instruction code.

Figure 6.1.1 shows an example of starting a read instruction (without software wait).

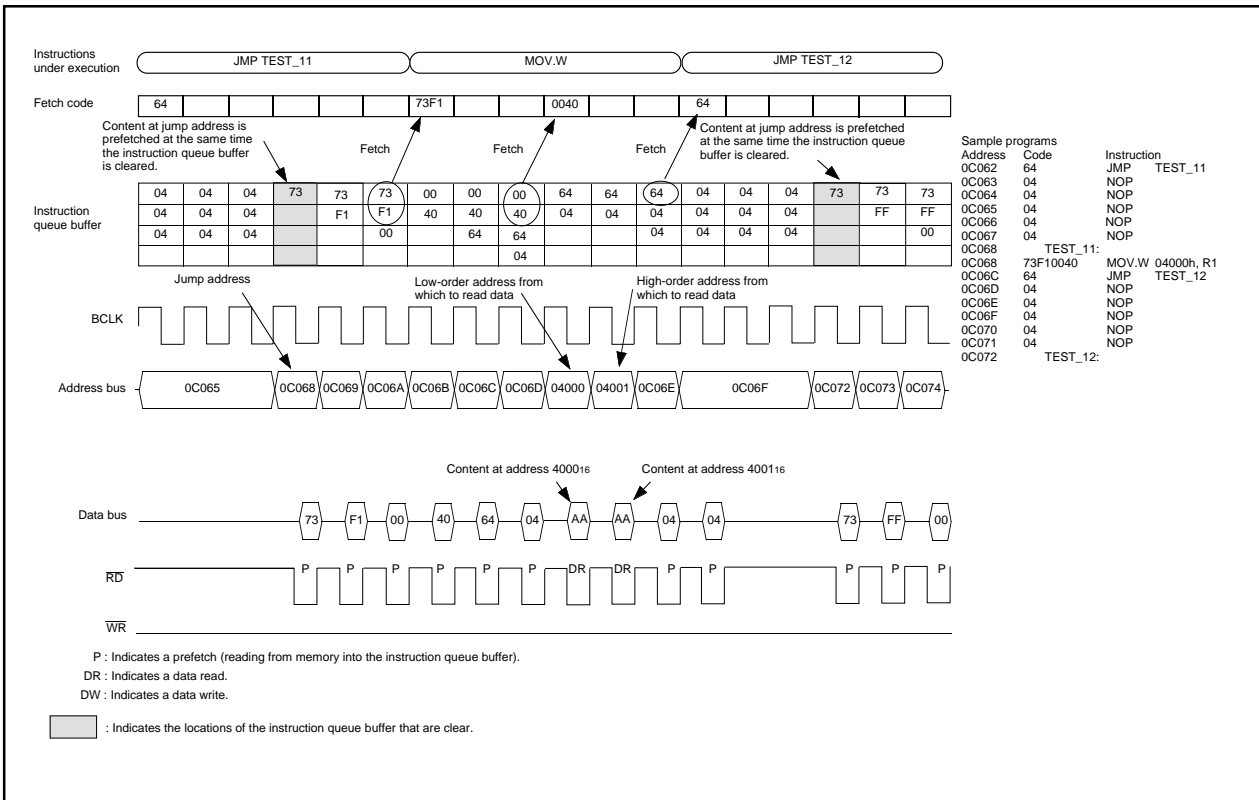

Figure 6.1.1 Starting a Read Instruction (without Software Wait States)

---

## Q & A

Information in Q&A form to help the user make the most of the R8C/Tiny Series is provided in this section. In general, one question and its corresponding answer are given on one page; the upper section is used for the question, the lower for the answer.

Functions closely connected with the issue being discussed are indicated in the upper-right corner.

---

**Q**

How do I distinguish between the static base register (SB) and the frame base register (FB)?

**A**

SB and FB function in the same manner, so you can use them as you like when in programming in assembly language. If you write a program in C, use FB as a stack frame base register.

Q

Is it possible to change the contents of the interrupt table register (INTB) while a program is being executed?

A

Yes. But there is a possibility of program runaway if an interrupt request occurs while changing the contents of INTB. It is therefore not recommended to frequently change the contents of INTB while a program is being executed.

---

**Q**

What is the difference between the user stack pointer (USP) and the interrupt stack pointer (ISP)?  
What are their roles?

**A**

USP is used when using the OS. When several tasks are run, the OS secures stack areas to save the contents of registers for individual tasks. Also, stack areas have to be secured, task by task, to be used for handling interrupts that occur while tasks are being executed. If you use USP and ISP in such an instance, the stack for interrupts can be shared by these tasks. This allows efficient use of stack areas.

Q

What happens to the instruction code if I use a bit instruction in absolute addressing ?

A

This explanation takes BSET bit, base:16 as an example.

This instruction is a 4-byte instruction. The 2 higher-order bytes of the instruction code indicate the operation code, and the 2 lower-order bytes make up the addressing mode to express bit,base:16.

The relation between the 2 lower-order bytes and bit,base:16 is as follows:

2 lower-order bytes = base:16  $\times$  8 + bit

For example, in the case of BSET 2,0AH (setting bit 2 of address 000A<sub>16</sub> to 1), the 2 lower-order bytes become  $A \times 8 + 2 = 52H$ .

In the case of BSET 18,8H (setting the 18th bit from bit 0 of address 0008<sub>16</sub> to 1), the 2 lower-order bytes become  $8 \times 8 + 18 = 52H$ , which is equivalent to BSET 2,AH.

The maximum value of base:16  $\times$  8 + bit, FFFFH, indicates bit 7 of address 1FFF<sub>16</sub>. This is the maximum bit you can specify when using a bit instruction in absolute addressing.

Q

What is the difference between the DIV instruction and the DIVX instruction?

A

The DIV instruction and the DIVX instruction are both instructions for signed division, but the sign of the remainder is different.

The sign of the remainder left after the DIV instruction is the same as that of the dividend, but the sign of the remainder of the DIVX instruction is the same as that of the divisor.

In general, the following relation among quotient, divisor, dividend, and remainder holds:

$\text{dividend} = \text{divisor} \times \text{quotient} + \text{remainder}$

Since the sign of the remainder is different between these instructions, the quotient obtained either by dividing a positive integer by a negative integer or by dividing a negative integer by a positive integer using the DIV instruction is different from that obtained using the DIVX instruction.

For example, dividing 10 by  $-3$  using the DIV instruction yields  $-3$  and leaves a remainder of  $+1$ , while doing the same using the DIVX instruction yields  $-4$  and leaves a remainder of  $-2$ .

Dividing  $-10$  by  $+3$  using the DIV instruction yields  $-3$  and leaves a remainder of  $-1$ , while doing the same using the DIVX instruction yields  $-4$  and leaves a remainder of  $+2$ .

---

## Glossary

Technical terms used in this software manual are explained in this section. They apply to in this manual only.

<b>Term</b>	<b>Meaning</b>	<b>Related word</b>
borrow	To move a digit to the next lower position.	carry
carry	To move a digit to the next higher position.	borrow
context	Registers that a program uses.	
decimal addition	Addition using decimal values.	
displacement	The difference between the initial position and a later position.	
effective address	The address actually used after modification.	
extension area	For the R8C/Tiny Series, the area from 10000 <sub>16</sub> through FFFFF <sub>16</sub> .	
LSB	Abbreviation for Least Significant Bit The bit occupying the lowest-order position in a data item.	MSB

<b>Term</b>	<b>Meaning</b>	<b>Related word</b>
macro instruction	An instruction, written in a source language, to be expressed in a number of machine instructions when compiled into a machine code program.	
MSB	Abbreviation for Most Significant Bit. The bit occupying the highest-order position in a data item.	LSB
operand	A part of instruction code that indicates the object of an operation.	operation code
operation	A generic term for move, comparison, bit processing, shift, rotation, arithmetic, logic, and branch.	
operation code	A part of an instruction code that indicates what sort of operation the instruction performs.	operand
overflow	To exceed the maximum expressible value as a result of an operation.	
pack	To join data items. Used to mean to form two 4-bit data items into one 8-bit data item, to form two 8-bit data items into one 16-bit data item, etc.	unpack
SFR area	Abbreviation for Special Function Register area. An area in which control bits for the on-chip peripheral circuits of the microcomputer and control registers are located.	

Term	Meaning	Related word
shift out	To move the content of a register either to the right or left until fully overflowed.	
sign bit	A bit that indicates either a positive or a negative (the highest-order bit).	
sign extension	To extend a data length in which the higher-order bits to be extended are made to have the same sign as the sign bit. For example, sign-extending FF <sub>16</sub> results in FFFF <sub>16</sub> , and sign-extending 0F <sub>16</sub> results in 000F <sub>16</sub> .	
stack frame	An automatic conversion area used by C language functions.	
string	A sequence of characters.	
unpack	To restore combined items or packed information to its original form. Used to mean to separate 8-bit information into two parts — 4 lower-order bits and 4 higher-order bits, to separate 16-bit information into two parts — 8 lower-order bits and 8 higher-order bits, and the like.	pack
zero extension	To extend a data length by turning higher-order bits to 0's. For example, zero-extending FF <sub>16</sub> to 16 bits results in 00FF <sub>16</sub> .	

---

## Table of Symbols

The symbols used in this software manual are explained in the following table. They apply to this manual only.

Symbol	Meaning
←	Transposition from the right side to the left side
↔	Interchange between the right side and the left side
+	Addition
−	Subtraction
×	Multiplication
÷	Division
∧	Logical conjunction
∨	Logical disjunction
⊕	Exclusive disjunction
¬	Logical negation
dsp16	16-bit displacement
dsp20	20-bit displacement
dsp8	8-bit displacement
EVA( )	An effective address indicated by what is enclosed in ( )
EXT( )	Sign extension
(H)	Higher-order byte of a register or memory
H4:	4 higher-order bits of an 8-bit register or 8-bit memory
	Absolute value
(L)	Lower-order byte of a register or memory
L4:	4 lower-order bits of an 8-bit register or 8-bit memory
LSB	Least Significant Bit
M( )	Content of memory indicated by what is enclosed in ( )
(M)	Middle-order byte of a register or memory
MSB	Most Significant Bit
PCH	Higher-order byte of the program counter
PCML	Middle-order byte and lower-order byte of the program counter
FLGH	4 higher-order bits of the flag register
FLGL	8 lower-order bits of the flag register

---

# Index

- A**
- A0 and A1 ... 5
  - A1A0 ... 5
  - Address register ... 5
  - Address space ... 3
  - Addressing mode ... 22
- B**
- B flag ... 6
  - Byte (8-bit) data ... 16
- C**
- C flag ... 6
  - Carry flag ... 6
  - Cycles ... 138
- D**
- D flag ... 6
  - Data arrangement in memory ... 17
  - Data arrangement in Register ... 16
  - Data register ... 4
  - Data type ... 10
  - Debug flag ... 6
  - Description example ... 37
  - dest ... 18
- F**
- FB ... 5
  - Fixed vector table ... 19
  - Flag change ... 37
  - Flag register ... 5
  - FLG ... 5
  - Frame base register ... 5
  - Function ... 37
- I**
- Interrupt table register ... 5
  - I flag ... 6
  - Instruction code ... 138
  - Instruction Format ... 18
  - Instruction format specifier ... 35
  - INTB ... 5
  - Integer ... 10
  - Interrupt enable flag ... 6
  - Interrupt stack pointer ... 5
  - Interrupt vector table ... 19
  - IPL ... 7
  - ISP ... 5
- L**
- Long word (32-bit) data ... 16
- M**
- Maskable interrupt ... 246
  - Memory bit ... 12
  - Mnemonic ... 35, 38
- N**
- Nibble (4-bit) data ... 16
  - Nonmaskable interrupt ... 246
- O**
- O flag ... 6
  - Operand ... 35, 38

---

Operation ... 37

Overflow flag ... 6

## P

PC ... 5

Processor interrupt priority level ... 7

Program counter ... 5

## R

R0, R1, R2, and R3 ... 4

R0H, R1H ... 4

R0L, R1L ... 4

R2R0 ... 4

R3R1 ... 4

Register bank ... 8

Register bank select flag ... 6

Register bit ... 12

Related instruction ... 37

Reset ... 9

## S

S flag ... 6

SB ... 5

Selectable src / dest (label) ... 37

Sign flag ... 6

Size specifier ... 35

Software interrupt number ... 20

src ... 18

Stack pointer ... 5

Stack pointer select flag ... 6

Static base register ... 5

String ... 15

Syntax ... 35, 38

## U

U flag ... 6

User stack pointer ... 5

USP ... 5

## V

Variable vector table ... 20

## W

Word (16-bit) data ... 16

## Z

Z flag ... 6

Zero flag ... 6

REVISION HISTORY

R8C/Tiny Series Software Manual

Rev.	Date	Description	
		Page	Summary
1.00	Jun 19, 2003	–	First edition issued
2.00	Oct 17, 2005	All pages 2	Featuring improved English “1.1.2 Speed Performance” revised

---

**R8C/Tiny Series SOFTWARE MANUAL**

**Publication Data : Rev.1.00 Jun 19, 2003  
Rev.2.00 Oct 17, 2005**

**Published by : Sales Strategic Planning Div.  
Renesas Technology Corp.**

---

# R8C/Tiny Series Software Manual



**Renesas Electronics Corporation**

1753, Shimonumabe, Nakahara-ku, Kawasaki-shi, Kanagawa 211-8668 Japan

REJ09B0001-0200Z