

To our customers,

Old Company Name in Catalogs and Other Documents

On April 1st, 2010, NEC Electronics Corporation merged with Renesas Technology Corporation, and Renesas Electronics Corporation took over all the business of both companies. Therefore, although the old company name remains in this document, it is a valid Renesas Electronics document. We appreciate your understanding.

Renesas Electronics website: <http://www.renesas.com>

April 1st, 2010
Renesas Electronics Corporation

Issued by: Renesas Electronics Corporation (<http://www.renesas.com>)

Send any inquiries to <http://www.renesas.com/inquiry>.

Notice

1. All information included in this document is current as of the date this document is issued. Such information, however, is subject to change without any prior notice. Before purchasing or using any Renesas Electronics products listed herein, please confirm the latest product information with a Renesas Electronics sales office. Also, please pay regular and careful attention to additional and different information to be disclosed by Renesas Electronics such as that disclosed through our website.
2. Renesas Electronics does not assume any liability for infringement of patents, copyrights, or other intellectual property rights of third parties by or arising from the use of Renesas Electronics products or technical information described in this document. No license, express, implied or otherwise, is granted hereby under any patents, copyrights or other intellectual property rights of Renesas Electronics or others.
3. You should not alter, modify, copy, or otherwise misappropriate any Renesas Electronics product, whether in whole or in part.
4. Descriptions of circuits, software and other related information in this document are provided only to illustrate the operation of semiconductor products and application examples. You are fully responsible for the incorporation of these circuits, software, and information in the design of your equipment. Renesas Electronics assumes no responsibility for any losses incurred by you or third parties arising from the use of these circuits, software, or information.
5. When exporting the products or technology described in this document, you should comply with the applicable export control laws and regulations and follow the procedures required by such laws and regulations. You should not use Renesas Electronics products or the technology described in this document for any purpose relating to military applications or use by the military, including but not limited to the development of weapons of mass destruction. Renesas Electronics products and technology may not be used for or incorporated into any products or systems whose manufacture, use, or sale is prohibited under any applicable domestic or foreign laws or regulations.
6. Renesas Electronics has used reasonable care in preparing the information included in this document, but Renesas Electronics does not warrant that such information is error free. Renesas Electronics assumes no liability whatsoever for any damages incurred by you resulting from errors in or omissions from the information included herein.
7. Renesas Electronics products are classified according to the following three quality grades: “Standard”, “High Quality”, and “Specific”. The recommended applications for each Renesas Electronics product depends on the product’s quality grade, as indicated below. You must check the quality grade of each Renesas Electronics product before using it in a particular application. You may not use any Renesas Electronics product for any application categorized as “Specific” without the prior written consent of Renesas Electronics. Further, you may not use any Renesas Electronics product for any application for which it is not intended without the prior written consent of Renesas Electronics. Renesas Electronics shall not be in any way liable for any damages or losses incurred by you or third parties arising from the use of any Renesas Electronics product for an application categorized as “Specific” or for which the product is not intended where you have failed to obtain the prior written consent of Renesas Electronics. The quality grade of each Renesas Electronics product is “Standard” unless otherwise expressly specified in a Renesas Electronics data sheets or data books, etc.
 - “Standard”: Computers; office equipment; communications equipment; test and measurement equipment; audio and visual equipment; home electronic appliances; machine tools; personal electronic equipment; and industrial robots.
 - “High Quality”: Transportation equipment (automobiles, trains, ships, etc.); traffic control systems; anti-disaster systems; anti-crime systems; safety equipment; and medical equipment not specifically designed for life support.
 - “Specific”: Aircraft; aerospace equipment; submersible repeaters; nuclear reactor control systems; medical equipment or systems for life support (e.g. artificial life support devices or systems), surgical implantations, or healthcare intervention (e.g. excision, etc.), and any other applications or purposes that pose a direct threat to human life.
8. You should use the Renesas Electronics products described in this document within the range specified by Renesas Electronics, especially with respect to the maximum rating, operating supply voltage range, movement power voltage range, heat radiation characteristics, installation and other product characteristics. Renesas Electronics shall have no liability for malfunctions or damages arising out of the use of Renesas Electronics products beyond such specified ranges.
9. Although Renesas Electronics endeavors to improve the quality and reliability of its products, semiconductor products have specific characteristics such as the occurrence of failure at a certain rate and malfunctions under certain use conditions. Further, Renesas Electronics products are not subject to radiation resistance design. Please be sure to implement safety measures to guard them against the possibility of physical injury, and injury or damage caused by fire in the event of the failure of a Renesas Electronics product, such as safety design for hardware and software including but not limited to redundancy, fire control and malfunction prevention, appropriate treatment for aging degradation or any other appropriate measures. Because the evaluation of microcomputer software alone is very difficult, please evaluate the safety of the final products or system manufactured by you.
10. Please contact a Renesas Electronics sales office for details as to environmental matters such as the environmental compatibility of each Renesas Electronics product. Please use Renesas Electronics products in compliance with all applicable laws and regulations that regulate the inclusion or use of controlled substances, including without limitation, the EU RoHS Directive. Renesas Electronics assumes no liability for damages or losses occurring as a result of your noncompliance with applicable laws and regulations.
11. This document may not be reproduced or duplicated, in any form, in whole or in part, without prior written consent of Renesas Electronics.
12. Please contact a Renesas Electronics sales office if you have any questions regarding the information contained in this document or Renesas Electronics products, or if you have any other inquiries.

(Note 1) “Renesas Electronics” as used in this document means Renesas Electronics Corporation and also includes its majority-owned subsidiaries.

(Note 2) “Renesas Electronics product(s)” means any product developed or manufactured by or for Renesas Electronics.

Renesas Starter Kit2+ for SH7264

User's Manual

RENEASAS SINGLE-CHIP MICROCOMPUTER
SuperH™ RISC engine

Disclaimer

By using this Renesas Starter Kit+ (RSK2+), the user accepts the following terms. The RSK2+ is not guaranteed to be error free, and the entire risk as to the results and performance of the RSK2+ is assumed by the User. The RSK2+ is provided by Renesas on an "as is" basis without warranty of any kind whether express or implied, including but not limited to the implied warranties of satisfactory quality, fitness for a particular purpose, title and non-infringement of intellectual property rights with regard to the RSK2+. Renesas expressly disclaims all such warranties. Renesas or its affiliates shall in no event be liable for any loss of profit, loss of data, loss of contract, loss of business, damage to reputation or goodwill, any economic loss, any reprogramming or recall costs (whether the foregoing losses are direct or indirect) nor shall Renesas or its affiliates be liable for any other direct or indirect special, incidental or consequential damages arising out of or in relation to the use of this RSK2+, even if Renesas or its affiliates have been advised of the possibility of such damages.

Precautions

This Renesas Starter Kit is only intended for use in a laboratory environment under ambient temperature and humidity conditions. A safe separation distance should be used between this and any sensitive equipment. Its use outside the laboratory, classroom, study area or similar such area invalidates conformity with the protection requirements of the Electromagnetic Compatibility Directive and could lead to prosecution.

The product generates, uses, and can radiate radio frequency energy and may cause harmful interference to radio communications. However, there is no guarantee that interference will not occur in a particular installation. If this equipment causes harmful interference to radio or television reception, which can be determined by turning the equipment off or on, you are encouraged to try to correct the interference by one or more of the following measures;

- ensure attached cables do not lie across the equipment
- reorient the receiving antenna
- increase the distance between the equipment and the receiver
- connect the equipment into an outlet on a circuit different from that which the receiver is connected
- power down the equipment when not in use
- consult the dealer or an experienced radio/TV technician for help NOTE: It is recommended that wherever possible shielded interface cables are used.

The product is potentially susceptible to certain EMC phenomena. To mitigate against them it is recommended that the following measures be undertaken;

- The user is advised that mobile phones should not be used within 10m of the product when in use.
- The user is advised to take ESD precautions when handling the equipment.

The Renesas Starter Kit does not represent an ideal reference design for an end product and does not fulfil the regulatory standards for an end product.

Table of Contents

Chapter 1. Preface	1
Chapter 2. Purpose	2
Chapter 3. Power Supply	3
3.1. Requirements	3
3.2. Power-up Behaviour	4
Chapter 4. Board Layout	5
4.1. Component Layout	5
4.2. Board Dimensions	6
Chapter 5. Block Diagram	7
Chapter 6. User Circuitry	8
6.1. Switches	8
6.2. LEDs	8
6.3. Potentiometer	9
6.4. Serial port	9
6.5. Debug LCD Module	9
6.6. RCAN	10
6.7. USB	10
6.8. ETHERNET	11
6.9. LCD Interface	12
6.10. SSI	12
6.11. SD Card	13
6.12. Video Decoder	14
6.13. Option Links	15
6.14. Oscillator Sources	19
6.15. Reset Circuit	19
Chapter 7. Modes	20
7.1. Boot modes	20
7.2. Clock operating modes	20
Chapter 8. Programming Methods	21
Chapter 9. Headers	22
9.1. Generic Headers	22
9.2. Generic TFT LCD Header	24
Chapter 10. Code Development	26
10.1. Overview	26
10.2. Compiler Restrictions	26
10.3. Breakpoint Support	26
10.4. Memory Map	27
Chapter 11. Component Placement	28

Chapter 1. Preface

Cautions

This document may be, wholly or partially, subject to change without notice.

All rights reserved. Duplication of this document, either in whole or part is prohibited without the written permission of Renesas Technology Europe Limited.

Trademarks

All brand or product names used in this manual are trademarks or registered trademarks of their respective companies or organisations.

Copyright

© 2010 Renesas Technology Europe Ltd. All rights reserved.

© 2010 Renesas Technology Corporation. All rights reserved.

© 2010 Renesas Solutions Corporation. All rights reserved.

Website: www.renesas.com

Glossary

ADC	Analog to Digital Converter	PC	Personal Computer
CD	Compact Disc	RAM	Random Access Memory
CPU	Central Processing Unit	RCAN	Renesas Controller Area Network
DAC	Digital to Analog Converter	ROM	Read-Only Memory
E10A	'E10A for Starter Kits' Debugger	RSK	Renesas Starter Kit
EMC	Electromagnetic compatibility	RSK2+	Renesas Starter Kit plus
ESD	Electrostatic Discharge	SCI	Serial Communication Interface
HEW	High-Performance Embedded Workshop	SD	Secure Digital
H-UDI	Hitachi - User Debug Interface	SDRAM	Synchronous Dynamic Random Access Memory
I/O	Input / Output	SPDIF	Sony/Philips Digital Interface
LCD	Liquid Crystal Display	SSI	Serial Sound Interface
LED	Light Emitting Diode	USB	Universal Serial Bus
MCU	Microcontroller Unit		

Chapter 2. Purpose

This RSK is an evaluation tool for Renesas microcontrollers.

Features include:

- Renesas Microcontroller Programming.
- User Code Debugging.
- User Circuitry such as switches, LEDs and potentiometer(s).
- Sample Application.
- Sample peripheral device initialisation code.

The RSK board contains all the circuitry required for microcontroller operation.

This manual describes the technical details of the RSK2+SH7264 hardware. The Quick Start Guide and Tutorial Manual provide details of the software installation and debugging environment.

Chapter 3. Power Supply

3.1. Requirements

This CPU board can operate from a 5V center positive power supply.

Table 3-1 and Table 3-2 below details the power supply connectors available on this RSK2+ board

CN7			
Pin	CPU board Signal Name	Pin	CPU board Signal Name
1	5VCC	2	5VCC
3	GROUND	4	GROUND

Table 3-1: Power Supply Connector CN7

CN8			
Pin	CPU board Signal Name	Pin	CPU board Signal Name
1	5VCC	2	NC
3	GROUND		

Note: The connector CN8 is fitted underneath the board.

Table 3-2: Power Supply Connector CN8

Please refer to the following table for on-board power supply connections -

	Setting	Description
Jumpers JP10	Fitted	3.3V is supplied at 3VCC net
	Removed	3.3V supply is disconnected from 3VCC net

Table 3-3: Power Supply Options for 3.3V

	Setting	Description
Jumpers JP11	Fitted	1.2V is supplied at 1.2VCC net
	Removed	1.2V supply is disconnected from 1.2VCC net

Table 3-4: Power Supply Options for 1.2V

Warning - Care must be taken to ensure that an appropriate supply is used. Failing to do this may cause permanent damage to the board.

This RSK2+ board is supplied with an E10A debugger.

This RSK2+ boards have a centre positive supply connector using a 2.0mm barrel power jack.

Warning - The CPU board is not over voltage protected. Use a centre positive supply for this board.

3.2. Power-up Behaviour

When the RSK is purchased the CPU board has the 'Release' or stand alone code from the example tutorial code pre-programmed into the Renesas microcontroller. On powering up the board, the user LEDs will start to flash. Pressing any switch will cause the LEDs to flash at a rate controlled by the potentiometer.

Chapter 4. Board Layout

4.1. Component Layout

The following diagram shows the top layer component layout of the board.

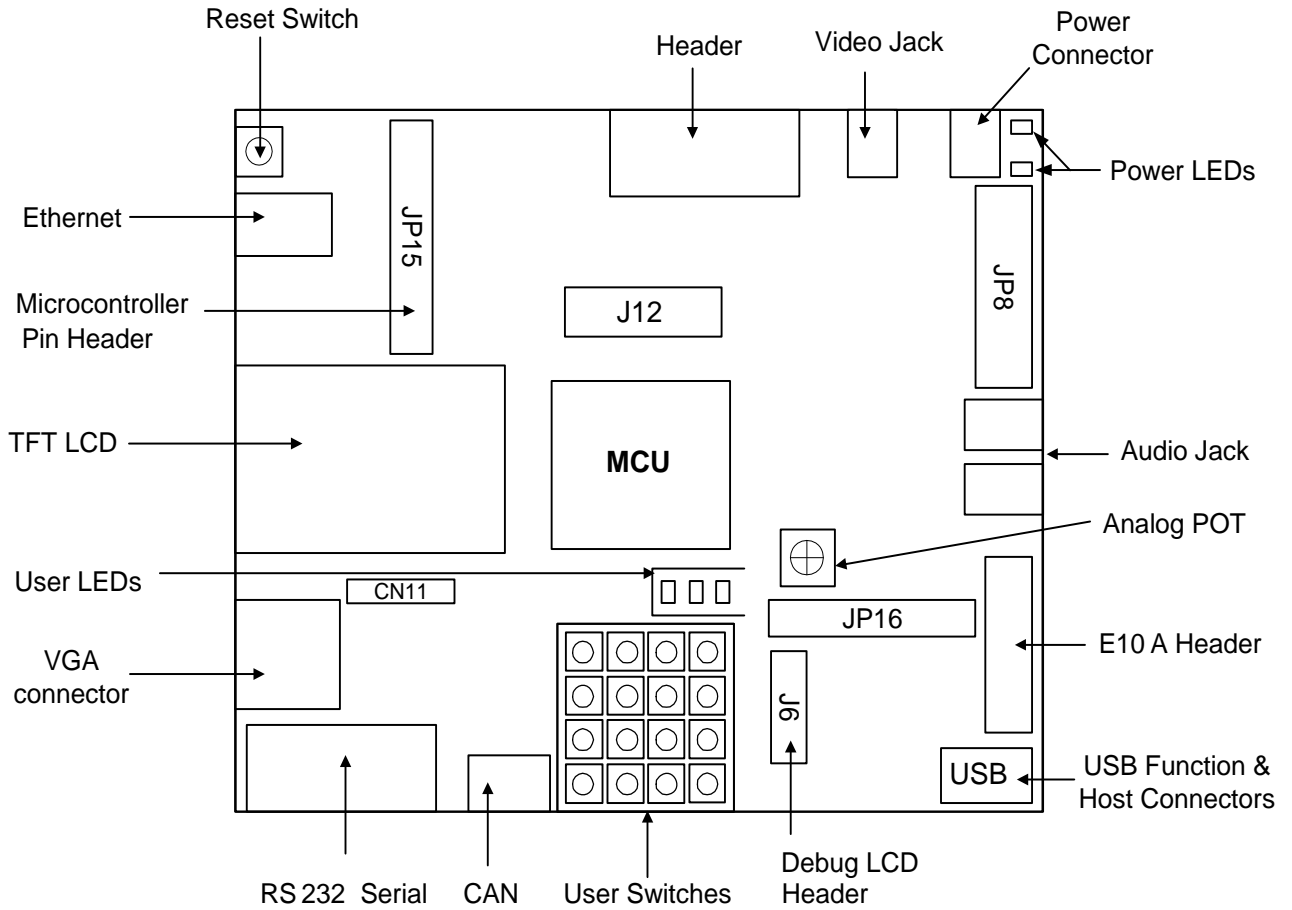

Figure 4-1: Board Layout

4.2. Board Dimensions

The following diagram gives the board dimensions and connector positions.

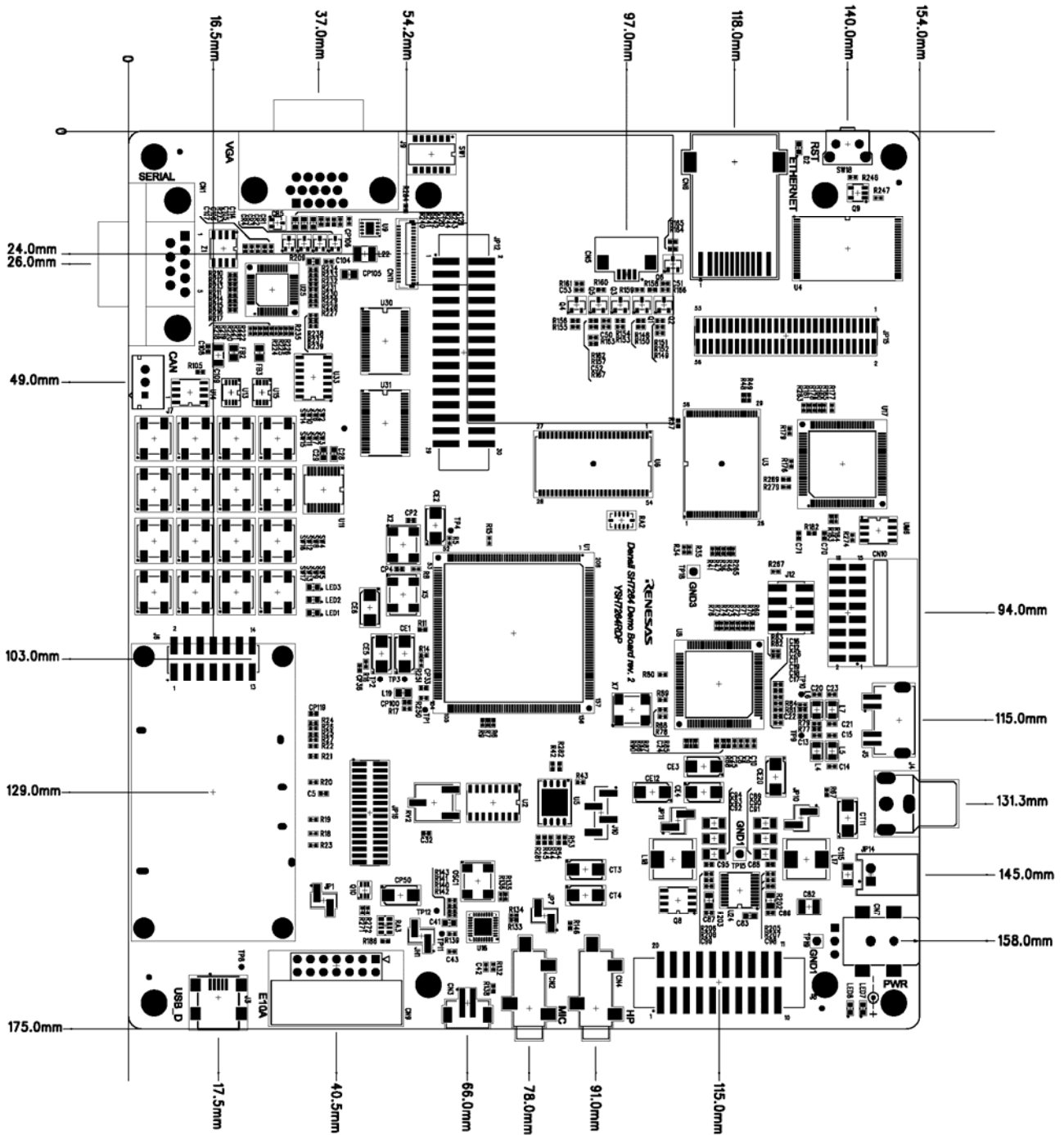

Figure 4-2: Board Dimensions

Chapter 5. Block Diagram

Figure 5-1 shows the CPU board components and their connectivity.

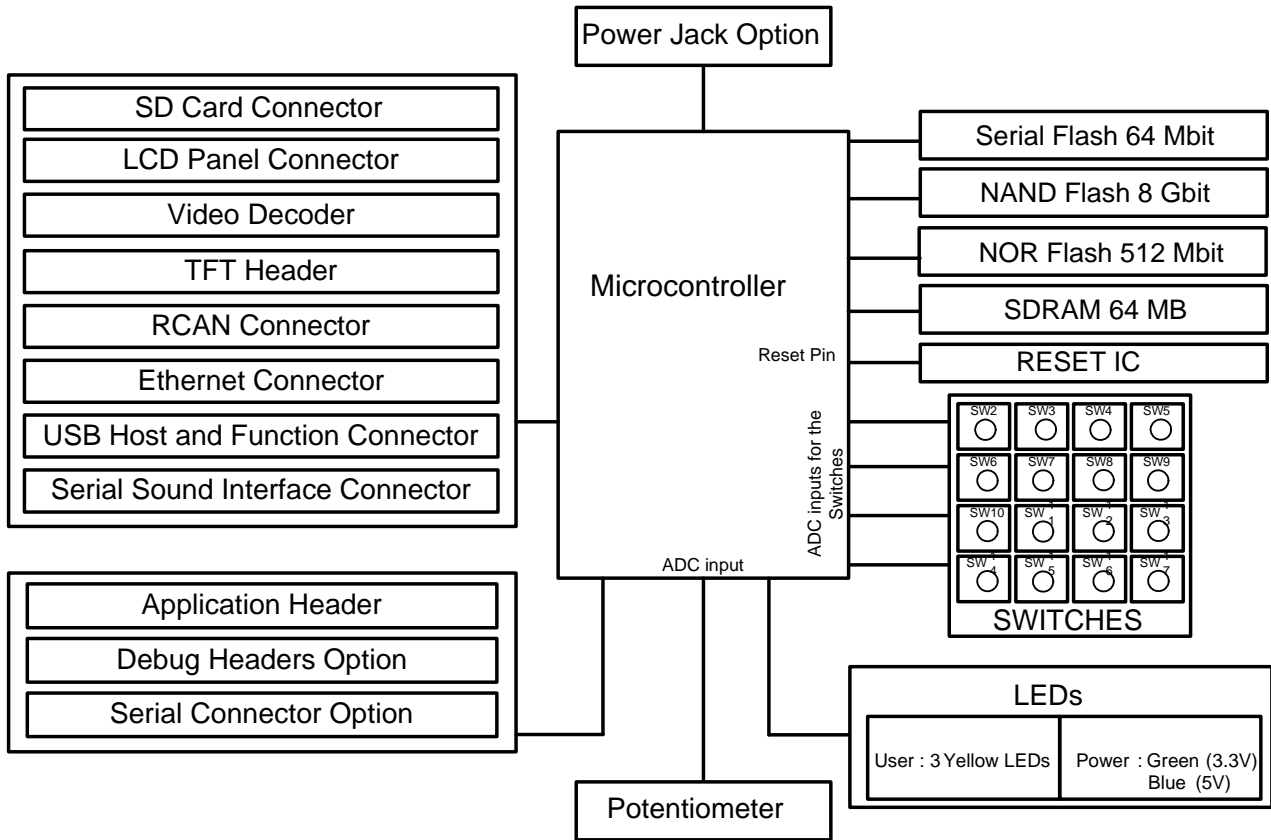

Figure 5-1: Block Diagram

Figure 5-2 shows E10A connections to the RSK2+ board.

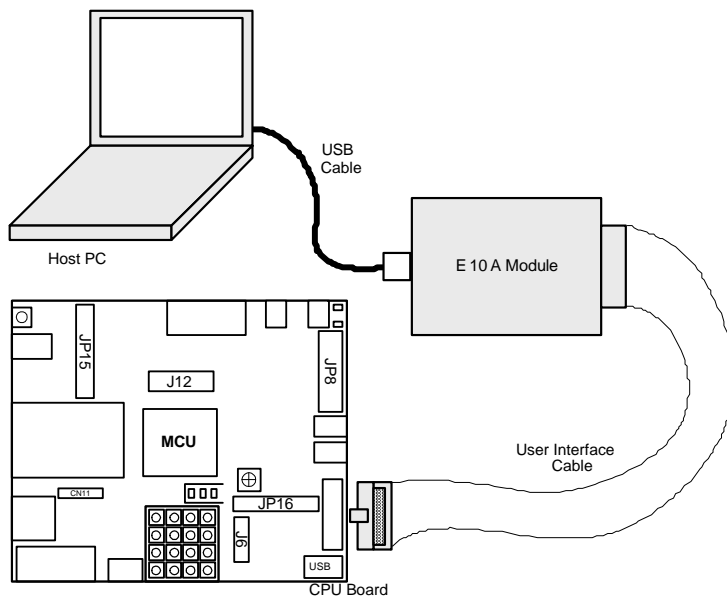

Figure 5-2: E10A RSK2+ Connections

Chapter 6. User Circuitry

6.1. Switches

There are 16 user switches connected in matrix form on the board in addition to the reset switch. They are connected to 4 ADC input Pins of the MCU. The function of each switch and its connection are shown in **Table 6-1**

Switch	Function	Microcontroller
RST / SW18	When pressed, the microcontroller is reset.	RES#, Pin 51
SW2	User Switch	PH0/AN0, Pin 94
SW3	User Switch	PH0/AN0, Pin 94
SW4	User Switch	PH0/AN0, Pin 94
SW5	User Switch	PH0/AN0, Pin 94
SW6	User Switch	PH1/AN1, Pin 95
SW7	User Switch	PH1/AN1, Pin 95
SW8	User Switch	PH1/AN1, Pin 95
SW9	User Switch	PH1/AN1, Pin 95
SW10	User Switch	PH2/AN2, Pin 96
SW11	User Switch	PH2/AN2, Pin 96
SW12	User Switch	PH2/AN2, Pin 96
SW13	User Switch	PH2/AN2, Pin 96
SW14	User Switch	PH3/AN3, Pin 97
SW15	User Switch	PH3/AN3, Pin 97
SW16	User Switch	PH3/AN3, Pin 97
SW17	User Switch	PH3/AN3, Pin 97

Table 6-1: Switch Functions

6.2. LEDs

There are 6 LEDs on the RSK2+ board. The green 'POWER' LED (LED8) lit when a 3.3V supply is connected to the power net 3VCC and blue 'POWER' LED (LED7) lights when the board is powered with 5V. The three user LEDs are connected to an IO port and will lit when their corresponding port pin is set low. An Orange LED (D2) will light when Ethernet connection is established.

Table 6-2 below shows the LED pin references and their corresponding microcontroller port pin connections.

LED Reference (As shown on silkscreen)	Colour	Microcontroller Port Pin function	Microcontroller Pin Number	Polarity
LED1	Yellow	PJ6	62	Active Low
LED2	Yellow	PJ7	61	Active Low
LED3	Yellow	PJ8	50	Active Low

Table 6-2: LED Port

6.3. Potentiometer

A single-turn potentiometer is connected to pin AN6 (Port PH6, pin 101) of the microcontroller. This may be used to vary the input analog voltage value to this pin between AVCC and Ground.

Note: The potentiometer is fitted to offer an easy way of supplying a variable analog input to the controller. It does not necessarily reflect the accuracy of the controller's ADC. Please see the device manual for details.

6.4. Serial port

The RS232 port is available at connector 'CN1' and uses microcontroller serial port SCIF3 for asynchronous serial communication. The board is designed to accept a straight-through RS-232 male-to-female cable.

6.5. Debug LCD Module

The LCD module supplied with the RSK2+ can be connected to the connector 'J6' for use with the tutorial code. Any module that conforms to the pin connections and has a KS0066u compatible controller can be used. The LCD module uses a 4bit interface to reduce the pin allocation. No contrast control is provided; this must be set on the display module.

The module supplied with the CPU board only supports 5V operation.

Table 6-3 shows the pin allocation and signal names used on this connector.

J6 (For LCD)					
Pin	Circuit Net Name	Device Pin	Pin	Circuit Net Name	Device Pin
1	Ground	-	2	5VCC	-
3	No Connection	-	4	PJ6	62
5	R/W (Wired to write only using 10K pull down)	-	6	PJ8 (+ 10k pull down to ground)	50
7	No Connection	-	8	No Connection	-
9	No Connection	-	10	No Connection	-
11	PJ7	61	12	PJ9	48
13	PJ10	46	14	PJ11	44

Table 6-3: Debug LCD Module Connections

6.6. RCAN

The SH7264 on-chip RCAN module offers a flexible and sophisticated way to organize and control CAN frames, providing the compliance to CAN2.0B Active and ISO-11898-1. There are 2 CAN channels available on the microcontroller but only one transceiver is available on the board. By default CAN0 is connected to the CAN transceiver. Option links provide easy interface to connect CAN1 channel to the transceiver instead of CAN0.

Table 6-4 details the required connections to connect either CAN0 or CAN1 channel to the transceiver –

CAN channel	Option Links R277, R278	Option Links R275, R276
CAN0	Fitted	Removed
CAN1	Removed	Fitted

Note: The default CAN setting on this RSK2+ is indicated by **BOLD** text.

Table 6-4: CAN Channel Selection

Table 6-5 details the CAN connectors available on this RSK2+ board –

CAN0		
Pin	Circuit Net Name	Device Pin
1	CANH	75*
2	CANL	73*
3	GND	-

* - The RCAN transceivers translate the voltage levels on CPU pin to meet RCAN voltage level standards.

Table 6-5: RCAN Connector

For more details on SH7264 on-chip RCAN module, please refer to *SH7264 Group Hardware Manual*.

6.7. USB

The USB 2.0 host/function module (USB) provides capabilities as a USB host and USB function. It supports high-speed and full-speed transfers defined by USB 2.0 specification. The Low speed mode is not supported. This module has a USB transceiver and supports all of the transfer types defined by the USB specification. The module has an 8-kbyte on-chip buffer memory for data transfer, providing a maximum of ten pipes. Any endpoint numbers can be assigned to PIPE1 to PIPE9, based on the peripheral devices or user system for communication.

Table 6-6 below details the USB connectors available on this RSK2+ board

USB Socket-A (USB Host) JP1 (1-2) short				USB Mini-B (USB Device / Function) JP1 (1-2) open			
Pin No	Pin Name	Circuit Net Name	Device Pin	Pin No	Pin Name	Circuit Net Name	Device Pin
1	VBUS	VBUS	84	1	VBUS	VBUS	84
2	D-	DM	82	2	D-	DM	82
3	D+	DP	83	3	D+	DP	83
4	GND	GROUND	---	4	ID	USB_ID	NC
5	FG2	USB_SHLD	---	5	GND	GROUND	---
6	FG1	USB_SHLD	---	6	FRAME	USB_SHLD	---
				7	FG1	USB_SHLD	---
				8	FG2	USB_SHLD	---
				9	FG3	USB_SHLD	---

Table 6-6: USB

For more details on SH7264 on-chip USB module, please refer to *SH7264 Group Hardware Manual*.

6.8. ETHERNET

The network functionality is provided by the SMSC LAN89218, a single-chip 10/100 Ethernet controller which incorporates essential protocol requirements for operating an Ethernet/IEEE 802.3 10BASE-T and 802.3u100BASE-TX node. The Ethernet controller is configured to use a 16 bit data bus. It uses single 16 bit read and write strobes. Byte accesses are not available for this device. The chip select used for the network controller is CS2.

The orange LED (D2) lights when Full-Duplex connection is established between the PHY device and any other connected Ethernet devices. The embedded Ethernet connector green LED lights when there is a link with the other devices. The yellow LED lights when there is a network activity.

Refer to the *SMCS LAN89218 datasheet* for more information on this peripheral.

Table 6-7 contains details of the signal descriptions and pin connections.

LED Reference (As shown on silkscreen)	Colour	LAN89218 Port Pin	LAN89218 Pin Number
DUPLEX	Orange	GPIO2_LED3#	100
Ethernet connector: LED_K_YELLOW	Yellow	GPIO0_LED1#	98
Ethernet connector: LED_K_GREEN	Green	GPIO1_LED2#	99

Table 6-7: Ethernet module settings

6.9. LCD Interface

Video Display Controller 3 in SH7264 supports TFT-LCD panel. Video Display Controller 3 uses the display and recording function to store the input data in the memory and then display the video on the panel. Hitachi TX06D57VM0AAA TFT LCD panel has been used on RSK2+SH7264 board. This panel has a resolution of 240 x 320 pixels. This panel is fitted at CN11 connector.

Table 6-8 below details the pin connections for CN11 connector available on this RSK2+ board

CN11 (For Hitachi LCD)					
Pin	CPU board Signal Name	Device Pin	Pin	CPU board Signal Name	Device Pin
1	GROUND	---	2	GROUND	---
3	GROUND	---	4	2_8VCC	---
5	2_8VCC	---	6	2_8VCC	---
7	GROUND	---	8	BLCD0_B1	144*
9	BLCD1_B2	143*	10	BLCD2_B3	141*
11	BLCD3_B4	139*	12	BLCD4_B5	137*
13	BLCD5_G0	136*	14	BLCD6_G1	135*
15	BLCD7_G2	134*	16	BLCD8_G3	133*
17	BLCD9_G4	132*	18	BLCD10_G5	131*
19	GROUND	---	20	BLCD11_R1	129*
21	BLCD12_R2	127*	22	BLCD13_R3	125*
23	BLCD14_R4	124*	24	BLCD15_R5	123*
25	BLCD_CLK	119*	26	BLCD_CL1_HSYNC	121*
27	BLCD_FLM_VSYNC	122*	28	BSSL1	114*
29	BRSPCK1	116*	30	BMOSI1	112*
31	BMISO1	111*	32	BRES#	51*
33	GROUND	---	34	VLED+	---
35	VLED +	---	36	VLED-	---
37	VLED -	---	38	GROUND	---
39	GROUND	---			

* - These CPU pins are externally buffered (U30 and U31).

Table 6-8: LCD Header CN11

6.10. SSI

The serial sound interface (SSI) is a module designed to send or receive audio data interface with various devices offering Sony/Philips Digital Interconnect Format (S/PDIF) compatibility. It also provides additional modes for other common formats, as well as support for multi-channel mode. Both transmitter and receiver modules are embedded. Audio Codec pins are available at header 'JP16'.

6.11. SD Card

SD card memory interface is provided in this controller.

Table 6-9 below details the SD Card header.

J1							
Pin	Header Name	Circuit Net Name	Device Pin	Pin	Header Name	Circuit Net Name	Device Pin
1	CD/DAT3	SD_D3	184	2	CMD	SD_CMD	183
3	VSS1	GROUND	---	4	VDD	3VCC_C	---
5	CLK	SD_CLK	180	6	VSS2	GROUND	---
7	DAT0	SD_D0	173	8	DAT1	SD_D1	172
9	DAT2	SD_D2	185	10	W_Protect	SD_WP	171
11	Card_Detect	SD_CD	170	12	COMMON	GROUND	---

Table 6-9: SD Card Header

6.12. Video Decoder

The video display controller provides video display function, video recording function, utility for overlaying graphics images on the input video, and function for outputting the control signals for the TFT-LCD panel.

Table 6-10 below details the Video Decoder header pin connections

CN10					
Pin	Circuit Net Name	Device Pin	Pin	Circuit Net Name	Device Pin
1	PE5/DV_HSYNC/SDA2	174	2	RES#	51
3	PE4/DV_VSYNC/SCL2	175	4	PE3/SDA1	176
5	PF0/DV_DATA0	168	6	PE2/SCL1	177
7	GROUND	---	8	3VCC	---
9	PF8/DV_CLK	158	10	PF4/DV_DATA4	162
11	PF1/DV_DATA1	166	12	PF5/DV_DATA5	161
13	PF2/DV_DATA2	164	14	PF6/DV_DATA6	160
15	PF3/DV_DATA3	163	16	PF7/DV_DATA7	159

Table 6-10: Video Decoder Header CN10

Table 6-11 below details the VGA connector pin connections

J9			
Header Pin	RSK2+ board Signal Name	Header Pin	RSK2+ board Signal Name
1	crt_red	2	crt_green
3	crt_blue	4	NC
5	GROUND	6	GROUND
7	GROUND	8	GROUND
9	NC	10	GROUND
11	NC	12	NC
13	LCD_CL1_HSYNC*	14	LCD_FLM_VSYNC*
15	NC		

Table 6-11: VGA Connector

* - These CPU pins are connected through a NAND gate

6.13. Option Links

In this section, the default configuration is indicated by **BOLD** text.

Table 6-12 describes the function of the option links associated with LCD configuration.

LCD interface Settings				
R209	LCD Interface	Connects Clock pin 26 of DAC to GROUND	Disconnects Clock pin 26 of DAC from GROUND	---
R210	LCD Interface	Connects signal R0 of Video DAC to ground	Disconnects signal R0 of Video DAC from ground	---
R212	LCD Interface	Connects signal R1 of Video DAC to ground	Disconnects signal R1 of Video DAC from ground	---
R213	LCD Interface	Connects signal R2 of Video DAC to ground	Disconnects signal R2 of Video DAC from ground	---
R211	LCD Interface	Connects signal R3 of Video DAC to PG11 (pin 129) of MCU	Disconnects signal R3 of Video DAC from PG11 (pin 129) of MCU	---
R214	LCD Interface	Connects signal R4 of Video DAC to PG12 (pin 127) of MCU	Disconnects signal R4 of Video DAC from PG12 (pin 127) of MCU	---
R215	LCD Interface	Connects signal R5 of Video DAC to PG13 (pin 125) of MCU	Disconnects signal R5 of Video DAC from PG13 (pin 125) of MCU	---
R216	LCD Interface	Connects signal R6 of Video DAC to PG14 (pin 124) of MCU	Disconnects signal R6 of Video DAC from PG14 (pin 124) of MCU	---
R217	LCD Interface	Connects signal R7 of Video DAC to PG15 (pin 123) of MCU	Disconnects signal R7 of Video DAC from PG15 (pin 123) of MCU	---
R218	LCD Interface	Connects signal G0 of Video DAC to ground	Disconnects signal G0 of Video DAC from ground	---
R219	LCD Interface	Connects signal G1 of Video DAC to ground	Disconnects signal G1 of Video DAC from ground	---
R220	LCD Interface	Connects signal G2 of Video DAC to PG5 (pin 136) of MCU	Disconnects signal G2 of Video DAC from PG5 (pin 136) of MCU	---
R221	LCD Interface	Connects signal G3 of Video DAC to PG6 (pin 135) of MCU	Disconnects signal G3 of Video DAC from PG6 (pin 135) of MCU	---
R222	LCD Interface	Connects signal G4 of Video DAC to PG7 (pin 134) of MCU	Disconnects signal G4 of Video DAC from PG7 (pin 134) of MCU	---
R224	LCD Interface	Connects signal G5 of Video DAC to PG8 (pin 133) of MCU	Disconnects signal G5 of Video DAC from PG8 (pin 133) of MCU	---
R225	LCD Interface	Connects signal G6 of Video DAC to PG9 (pin 132) of MCU	Disconnects signal G6 of Video DAC from PG9 (pin 132) of MCU	---
R226	LCD Interface	Connects signal G7 of Video DAC to PG10 (pin 131) of MCU	Disconnects signal G7 of Video DAC from PG10 (pin 131) of MCU	---

R227	LCD Interface	Connects signal B0 of Video DAC to ground	Disconnects signal B0 of Video DAC from ground	---
R228	LCD Interface	Connects signal B1 of Video DAC to ground	Disconnects signal B1 of Video DAC from ground	---
R229	LCD Interface	Connects signal B2 of Video DAC to ground	Disconnects signal B2 of Video DAC from ground	---
R230	LCD Interface	Connects signal B3 of Video DAC to PG0 (pin 144) of MCU	Disconnects signal B3 of Video DAC from PG0 (pin 144) of MCU	---
R231	LCD Interface	Connects signal B4 of Video DAC to PG1 (pin 143) of MCU	Disconnects signal B4 of Video DAC from PG1 (pin 143) of MCU	---
R232	LCD Interface	Connects signal B5 of Video DAC to PG2 (pin 141) of MCU	Disconnects signal B5 of Video DAC from PG2 (pin 141) of MCU	---
R233	LCD Interface	Connects signal B6 of Video DAC to PG3 (pin 139) of MCU	Disconnects signal B6 of Video DAC from PG3 (pin 139) of MCU	---
R238	LCD Interface	Connects the BLANK pin of Video DAC to PG18 (pin 120) of MCU	Disconnects the BLANK pin of Video DAC from PG18 (pin 120) of MCU	---
R234	LCD Interface	Connects signal B7 of Video DAC to PG4 (pin 137) of MCU	Disconnects signal B7 of Video DAC from PG4 (pin 137) of MCU	---
R268	LCD Interface	Connects PJ2 pin of MCU to LCD_M_DISP pin of TFT LCD connector (JP12)	Disconnects PJ2 pin of MCU from LCD_M_DISP pin of TFT LCD connector (JP12)	R269, R275

Table 6-12: LCD Configuration links

Table 6-13 describes the function of miscellaneous option links.

Option Link Settings				
Reference	Function	Fitted	Alternative (Removed)	Related To
R266	Touch Screen Configuration	Connects ADGTRG pin to 3VCC	Disconnects ADGTRG pin from 3VCC	R267, R236
R267	Touch Screen Configuration	Connects IRQ0 pin of the MCU to 3VCC	Disconnects IRQ0 pin of the MCU from 3VCC	R266, R236
R236	Touch Screen Configuration	Connects pin 2 of header 'J12' to port pin PC9 of MCU	Disconnects pin 2 of header 'J12' from port pin PC9 of MCU	R266, R267
R275	CAN Configuration	Connects PJ2 pin of MCU to CTX1 pin of voltage translator circuit in CAN module.	Disconnects PJ2 pin of MCU from CTX1 pin of voltage translator.	R268, R269, R276
R276	CAN Configuration	Connects IRQ1 pin of MCU to CXR1 pin of voltage translator in CAN module.	Disconnects IRQ1 pin of MCU from CXR1 pin of voltage translator in CAN module.	R275
R277	CAN Configuration	Connects the CTX0 of MCU pin to pin 3 of voltage translator in CAN circuit	Disconnects the CTX0 of MCU pin from pin 3 of voltage translator in CAN circuit	---

R278	CAN Configuration	Connects the CRX0 of MCU pin to pin 3 of voltage translator in CAN circuit	Disconnects the CRX0 of MCU pin from pin 3 of voltage translator in CAN circuit	---
R53	Serial Flash Interface	Connects RESET pin of Serial Flash to 3VCC	Disconnects RESET pin of Serial Flash from 3VCC	R54
R54	Serial Flash Interface	Connects RESET pin of Serial Flash to the CPU reset pin	Disconnects RESET pin of Serial Flash from CPU reset pin	R53
R281	Serial Flash Interface	Connects the D pin of Serial Flash to pin 3 of J10 connector	Disconnects the D pin of Serial Flash from pin 3 of J10 connector	---
R282	Serial Flash Interface	Connects the Q pin of Serial Flash to pin 2 of J10 connector and MCU port pin PF2	Disconnects the Q pin of Serial Flash from pin 2 of J10 connector and MCU port pin PF2	---
R65	SDRAM Interface	Pull down resistor for CKE pin of the MCU	Disconnects CKE pin of MCU from the Pull down resistor	---
R32	NAND Flash Interface	Connects the WP pin of NAND flash memory to 3VCC	Disconnects the WP pin of NAND flash memory from 3VCC	---
R33	NOR Flash interface	Connects an external address line A25 of MCU to pin 56 of NOR Flash memory	Disconnects the address line A25 of MCU from pin 56 of Nor Flash memory	R37
R34	NOR Flash interface	Connects an external address line A24 of MCU to pin 1 of NOR Flash memory	Disconnects the address line A24 from pin 1 of Nor Flash memory	R38
R35	NOR Flash interface	Connects an external address line A23 of MCU to pin 2 of NOR Flash memory	Disconnects the address line A23 from pin 2 of Nor Flash memory	R39
R36	NOR Flash interface	Connects an external address line A22 to pin 15 of NOR Flash memory	Disconnects the address line A22 from pin 15 of NOR Flash memory	R40
R86	Video Decoder	Pull up resistor for the MCU pin CLKINV	Disconnects the pull up from CLKINV pin	R90
R90	Video Decoder	Connects CLKINV pin of Video Decoder to ground	Disconnects CLKINV pin of Video Decoder from ground	R86
R1	Power Supply	Connects 1.2VCC to PLL1.2V	Disconnects 1.2VCC from PLL1.2V	---
R252	Power Supply	Connects 1.2VCC to UA1.2V	Disconnects 1.2VCC from UA1.2V	---
R251	Power Supply	Connects 3VCC_CPU to UA3V	Disconnects 3VCC_CPU from UA3V	---
R250	Power Supply	Connects 3VCC_CPU to AVcc	Disconnects 3VCC_CPU from AVcc	---
R253	Oscillator	Connects X9 Crystal to EXTAL pin 57 of MCU	Disconnects crystal 'X9' from EXTAL pin 57 of MCU	---
R248	USB	Parallel resistor for inductor L1	Parallel resistor removed	---
R249	USB	Parallel resistor for inductor L3	Parallel resistor removed	---
R57	USB	Connects 5V supply to the Supply pin of power distribution switch MIC2025 (U7)	Disconnects 5V supply from the supply pin of U7	

R68	Video Decoder	Connects IIC bus address select (pin 73) of Video decoder to 3VCC	Disconnects IIC bus address select (pin 73) of Video decoder from pull up circuit.	R78
R78	Video Decoder	Connects IIC bus control pin 73 of Video decoder to ground	Disconnects IIC bus control pin 73 of Video decoder from ground	R68
R91	User Port	Connects the control input pin 1 of multiplexer to the RES pin of MCU	Disconnects the control input pin 1 of multiplexer from the RES pin of MCU	R280, R92
R280	User Port	Connects the control input pin 1 of multiplexer to PG20 (pin 118) of MCU	Disconnects the control input pin 1 of multiplexer from PG20 (pin 118) of MCU	R91, R92
R140	Audio Interface	Connects Data input pin 17 of Audio driver to MCU port pin PE3 (pin 176)	Disconnects Data input pin 17 of Audio driver from MCU port pin PE3 (pin 176)	---
R141	Audio Interface	Connects clock input pin 16 of Audio driver to MCU port pin PE2 (pin 177)	Disconnects clock input pin 16 of Audio driver from MCU port pin PE2 (pin 177)	---
R133	Audio Interface	Connects ADC and DAC sample rate clock pin 7 of audio driver to SSIWS0 (pin 147) of MCU	Disconnects ADC and DAC sample rate clock pin 7 of audio driver from SSIWS0 (pin 147) of MCU	---
R134	Audio Interface	Connects digital audio clock pin 8 of audio driver to SSISCK0 (pin 148) of the MCU	Disconnects digital audio clock pin 8 of audio driver from SSISCK0 (pin 148) of the MCU	---
R135	Audio Interface	Connects ADC Data output (pin 9) of audio driver to SSIRXD0 (pin 146) of the MCU	Disconnects ADC Data output (pin 9) of audio driver from SSIRXD0 (pin 146) of the MCU	---
R136	Audio Interface	Connects DAC data input pin 10 of audio driver to SSITXD0 (pin 145) of the MCU	Disconnects DAC data input (pin 10) of audio driver from SSITXD0 (pin 145) of the MCU	---
R143	Audio Interface	Connects chip select pin of audio driver to AUDIO_X1 (pin 150) of the MCU	Disconnects chip select pin of audio driver from AUDIO_X1 (pin 150) of the MCU	---
R139	Audio Interface	Connects the analog output pin 21 of audio driver to TP11 on board	Disconnects the analog output pin 21 of audio driver from TP11 on board	---
R137	MIC	Connects the pin 1 of CN2 connector to ground	Disconnects the pin 1 of CN2 connector from ground	---
R146	Headphone	Connects the pin 4 of CN4 connector to GPIO2 pin of audio driver	Disconnects the pin 4 of CN4 connector from GPIO2 pin of audio driver	---
R269	Ethernet Configuration	Connects PJ2 (pin 71) of MCU to Chip select pin of Ethernet	Disconnects PJ2 (pin 71) of MCU from chip select pin of Ethernet	R268, R275
R283	Ethernet Configuration	Connects pin FIFO_SEL of LAN89218 to the external address pin A11 (pin 28) of the MCU	Disconnects pin FIFO_SEL of LAN89218 from the address pin A11 (pin 28) of the MCU	R179

R284	Ethernet Configuration	Connects the interrupt request pin of Ethernet controller to IRQ1 pin (port pin 70) of MCU	Disconnects the interrupt request pin of Ethernet controller from IRQ1 (pin 70) of MCU	---
R265	Ethernet Configuration	Connects 'endianess select' pin of Ethernet controller to the address pin A22 (pin 43) of MCU	Disconnects 'endianess select' pin of Ethernet controller from the address pin A22 (pin 43) of MCU	---

Table 6-13: Miscellaneous Configuration links

6.14. Oscillator Sources

Oscillators are fitted on the CPU board and used to supply various clock inputs to the Renesas microcontroller. Table 6-14 details the oscillators that are fitted and alternative footprints provided on this CPU board:

Component			
Oscillator (X1)	Fitted	25.175MHz	LCD Clock
Oscillator (X2)	Not Fitted	-	For Test Purposes
Crystal (X4)	Fitted	32.768KHz	Real Time Clock
Oscillator (X5)	Not Fitted	-	For Test Purposes
Crystal (X6)	Fitted	48 MHz	USB Clock
Oscillator (X7)	Fitted	24.576MHz	Video Decoder Clock
Crystal (X9)	Fitted	18 MHz	System Clock
Oscillator (OSC1)	Fitted	13Mhz	External DAC/ADC Clock
Crystal (Y1)	Fitted	25MHz	Ethernet Clock

Table 6-14: Oscillators / Resonators

6.15. Reset Circuit

The CPU Board includes a Reset IC DS1819C (Q9) to meet the minimum reset period of 200 msec. The DS1819 monitor three vital conditions for a microprocessor: power supply, software execution, and external override. Please refer to the hardware manual for more information on the requirements of the reset circuit. Please check the reset requirements carefully to ensure the reset circuit on the user's board meets all the reset timing requirements.

Chapter 7. Modes

7.1. Boot modes

The boot modes supported by this RSK2+ board are listed in **Note:** Please ensure that SW1-6 is ON

Table 7-1.

Boot Mode	SW1-1 (MD_BOOT1 pin)	SW1-2 (MD_BOOT0 pin)	Description
0	ON	ON	Boots the MCU, from the 4MB NOR flash memory (connected to the CS0 space)
1	ON	OFF	Boots the MCU, through high-speed communication, from the 8MB serial flash memory (connected to channel 0 of SPI interface)
2	OFF	ON	Boots the MCU from the 512 MB NAND flash memory (connected to the NAND flash memory controller interface)
3	OFF	OFF	Boots the MCU, through low-speed communication, from the 8MB serial flash memory (connected to channel 0 of SPI interface)

Note: Please ensure that SW1-6 is ON

Table 7-1: Boot Mode pin settings

The default boot mode of this RSK2+ is indicated by **BOLD** text.

For more information on the boot modes listed above, please refer to the *SH7264 group hardware manual*.

7.2. Clock operating modes

This RSK2+ supports following clock operating modes -

Mode	SW1-3 (MD_CLK1 pin)	SW1-4 (MD_CLK0 pin)	Clock Source
0	ON	ON	EXTAL or crystal resonator
1	ON	OFF	USB_X1 or crystal resonator
2	OFF	ON	EXTAL or crystal resonator
3	OFF	OFF	USB_X1 or crystal resonator

Note: Please ensure that SW1-6 is ON

Table 7-2: Boot Mode pin settings

The default clock operating mode of this RSK2+ is indicated by **BOLD** text.

For more information on the clock operating modes listed above, please refer to the *SH7264 group hardware manual*.

Chapter 8. Programming Methods

The board is intended for use with HEW and the supplied E10A debugger. Refer to *SH7262/SH7264 Group Hardware Manual* for details of programming/ debugging without using these tools.

Chapter 9. Headers

9.1. Generic Headers

Table 9-1 to Table 9-2 below show the standard generic header connections.

Header Pin	CPU board Signal Name	Device pin	Header Pin	CPU board Signal Name	Device pin
1	5VCC	---	2	3VCC	---
3	A22	43	4	PD15	186
5	A21	42	6	PD14	187
7	A20	41	8	PD13	188
9	A19	40	10	PD12	189
11	A18	39	12	PD11	190
13	A17	38	14	PD10	191
15	A16	34	16	PD9	194
17	A15	32	18	PD8	195
19	GROUND	---	20	GROUND	---
21	A14	31	22	PD7	196
23	A13	30	24	PD6	197
25	A12	29	26	PD5	198
27	A11	28	28	PD4	199
29	A10	27	30	PD3	200
31	A9	25	32	PD2	202
33	A8	23	34	PD1	204
35	A7	21	36	PD0	206
37	GROUND	---	38	GROUND	---
39	A6	20	40	PC0/CS0#	207
41	A5	19	42	PC1/RD#	208
43	A4	18	44	PC2/RD/WR#	1
45	A3	17	46	PC3/WE0#/DQML	2
47	A2	16	48	PC4/WE1#/DQMU	4
49	A1	15	50	PC5B/RAS#	8
51	PJ9/PWM2F/TEND1	48	52	PC6B/CAS#	9
53	PJ10/PWM2G/DREQ1	46	54	PC7B/CKE	11
55	PJ11/PWM2H/DACK1	44	56	PC8B/CS3#	13

Table 9-1: JP15 microcontroller header

Header Pin	CPU board Signal Name	Device pin	Header Pin	CPU board Signal Name	Device pin
1	5VCC	---	2	3VCC	---
3	PC9	6	4	PH0/AN0	94
5	PC10	7	6	PH1/AN1	95
7	GROUND	---	8	PH2/AN2	96
9	SD_CD	170	10	PH3/AN3	97
11	SD_WP	171	12	GROUND	---
13	SD_D1	172	14	TP_AN4	98
15	SD_D0	173	16	TP_AN5	99
17	SD_CLK	180	18	NMI	52
19	SD_CMD	183	20	GROUND	---
21	SD_D3	184	22	SSISCK0	148
23	SD_D2	185	24	PJ0/CTX0/IETXD	75
25	GROUND	---	26	PJ1/CRX0/IERXD	73
27	SSITxD0	145	28	---	---
29	SSIRxD0	146	30	---	---
31	SSIWS0	147	32	GROUND	---

Table 9-2: JP16 microcontroller header

9.2. Generic TFT LCD Header

Generic TFT LCD header connections are detailed in Table 9-3.

JP12							
Header Pin	Generic TFT LCD Header Name	RSK2+ board Signal Name	Device Pin	Header Pin	Generic TFT LCD Header Name	RSK2+ board Signal Name	Device Pin
1	---	3VCC	---	2	---	3VCC	---
3	---	3VCC	---	4	LCD15_R5	PG15	123
5	LCD14_R4	PG14	124	6	LCD13_R3	PG13	125
7	LCD12_R2	PG12	127	8	LCD11_R1	PG11	129
9	LCD10_G5	PG10	131	10	LCD9_G4	PG9	132
11	LCD8_G3	PG8	133	12	LCD7_G2	PG7	134
13	LCD6_G1	PG6	135	14	LCD5_G0	PG5	136
15	LCD4_B5	PG4	137	16	LCD3_B4	PG3	139
17	LCD2_B3	PG2	141	18	LCD1_B2	PG1	143
19	LCD0_B1	PG0	144	20	---	GROUND	---
21	VLCD_CLK	NC	---	22	LCD_CL1_HSYNC	PG17	121
23	---	NC	---	24	---	NC	---
25	LCD_FLM_VSYNC	PG16	122	26	LCD_DISP	PG18	120
27	LCD_M_DISP	LCD_M_DISP	71	28	---	GROUND	---
29	---	GROUND	---	30	---	GROUND	---

Table 9-3: Generic TFT LCD Header

Generic MTU2 header connections are detailed in **Table 9-4**.

J8					
Header Pin	RSK2+ board Signal Name	Device Pin	Header Pin	RSK2+ board Signal Name	Device Pin
1	PH6/AN6	101	2	PH7/AN7	103
3	GROUND	---	4	GROUND	---
5	PG21/RSPCK1/TIOC0A	116	6	PG22/SSL1/TIOC0B	114
7	PG23/MOSI1/TIOC0C	112	8	PG24/MISO1/TIOC0D	111
9	GROUND	---	10	GROUND	---
11	PJ6/TIOC1A	62	12	PJ7/TIOC1B	61
13	IRQ1	70	14	CS2	71
15	PJ4/RXD3	65	16	PJ5/TXD3	63
17	---	NC	18	---	NC
19	PJ8/PWM2E	50	20	---	NC

Table 9-4: MTU2 Header

Generic SPDIF header connections are detailed in **Table 9-5**.

J10					
Header Pin	RSK2+ board Signal Name	Device Pin	Header Pin	RSK2+ board Signal Name	Device Pin
1	3VCC	---	2	SPDIF_OUT	151
3	SPDIF_IN	153	4	GROUND	---

Table 9-5: SPDIF Header

Chapter 10. Code Development

10.1. Overview

Note: For all code debugging using Renesas software tools, the CPU board must be connected to a PC USB port via an E10A. An E10A is supplied with the RSK2+ product.

An E10A supplied with this kit is an on-chip debugging emulator which supports the H-UDI interface of the target device. The H-UDI uses a 14-pin interface and marked as *E10A* on the RSK2+SH7264 board.

Due to the continuous process of improvements undertaken by Renesas the user is recommended to review the information provided on the Renesas website at www.renesas.com to check for the latest updates to the Compiler and Debugger manuals.

10.2. Compiler Restrictions

The compiler supplied with this RSK2+ is fully functional for a period of 60 days from first use. After the first 60 days of use have expired, the compiler will default to a maximum of 256k code and data. To use the compiler with programs greater than this size you will need to purchase the full version tools from your Renesas distributor

Warning: The protection software for the compiler will detect changes to the system clock. Changes to the system clock back in time may cause the trial period to expire prematurely.

10.3. Breakpoint Support

Limited Event Conditions can be located in ROM code which is directly supported by E10A emulator. To enable breakpoints in RAM following command needs to be included in the script –

```
> SH2A_SBSTK enable
```

For more information on this, please refer to the *SuperH™ Family E10A-USB Emulator Additional Document for User's Manual* for SH7264.

10.4. Memory Map

The memory map shown in this section visually describes the memory areas of RSK2+SH7264.

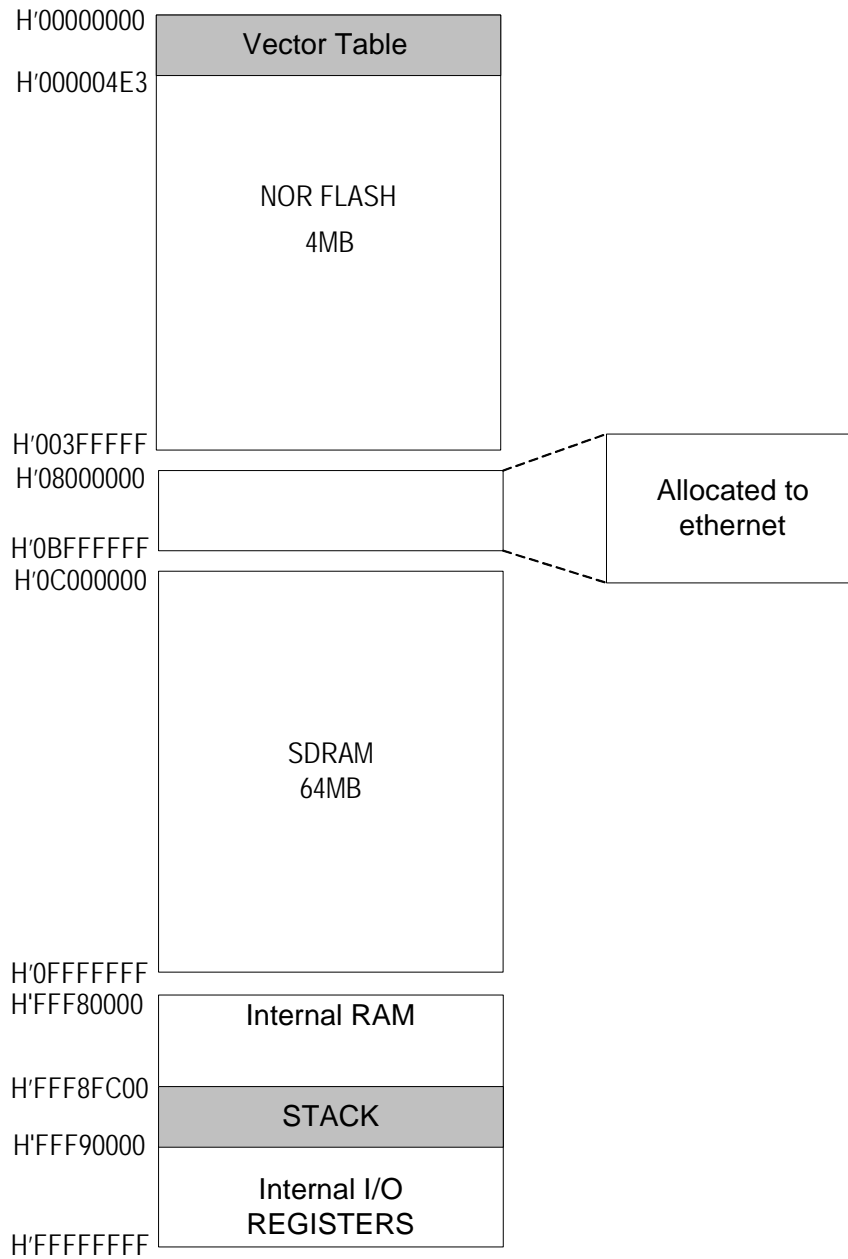

Figure 10-1: RSK2+SH7264 Memory Map

Chapter 11. Component Placement

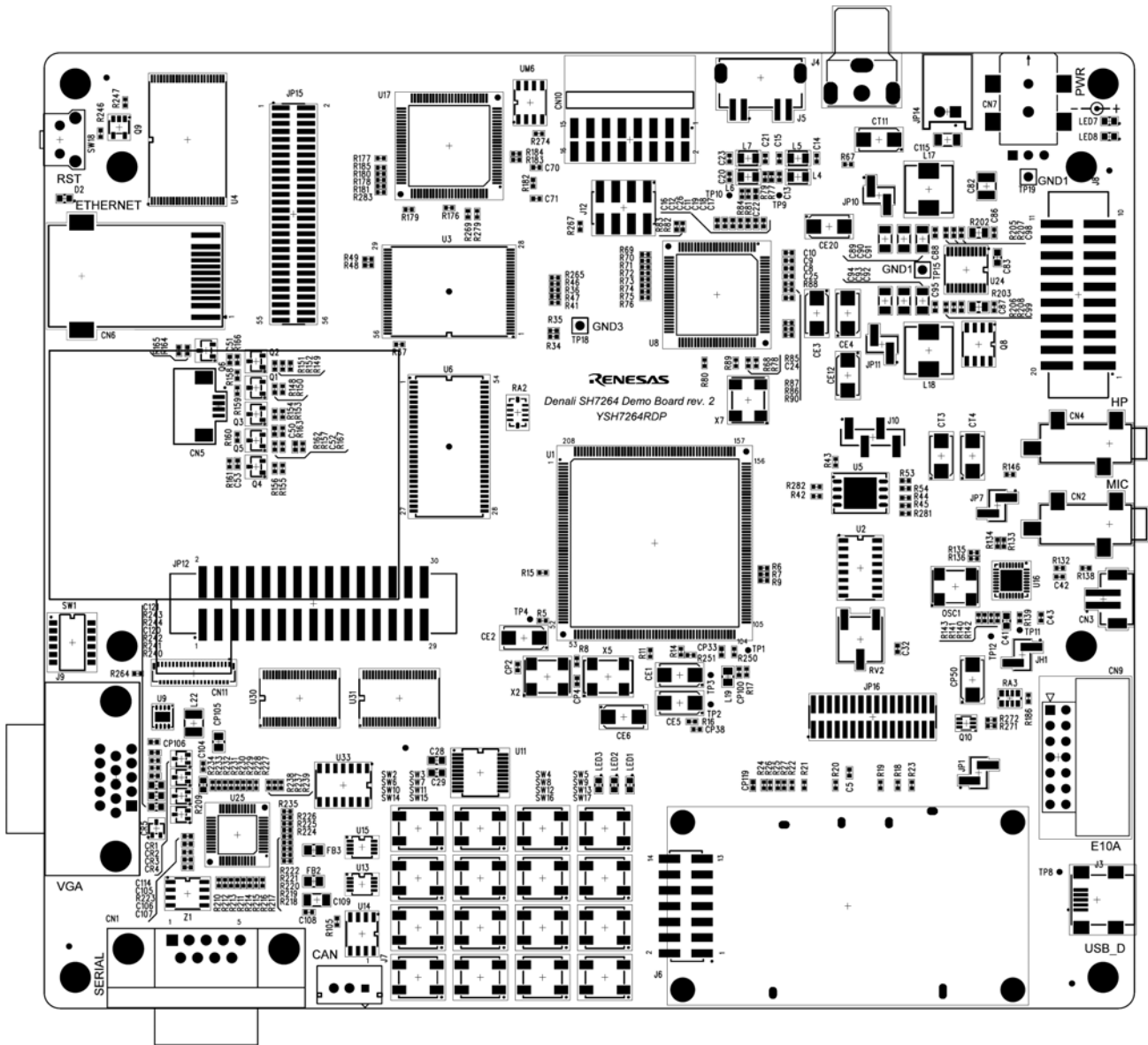

Figure 11-1: Component Placement (Top Layer)

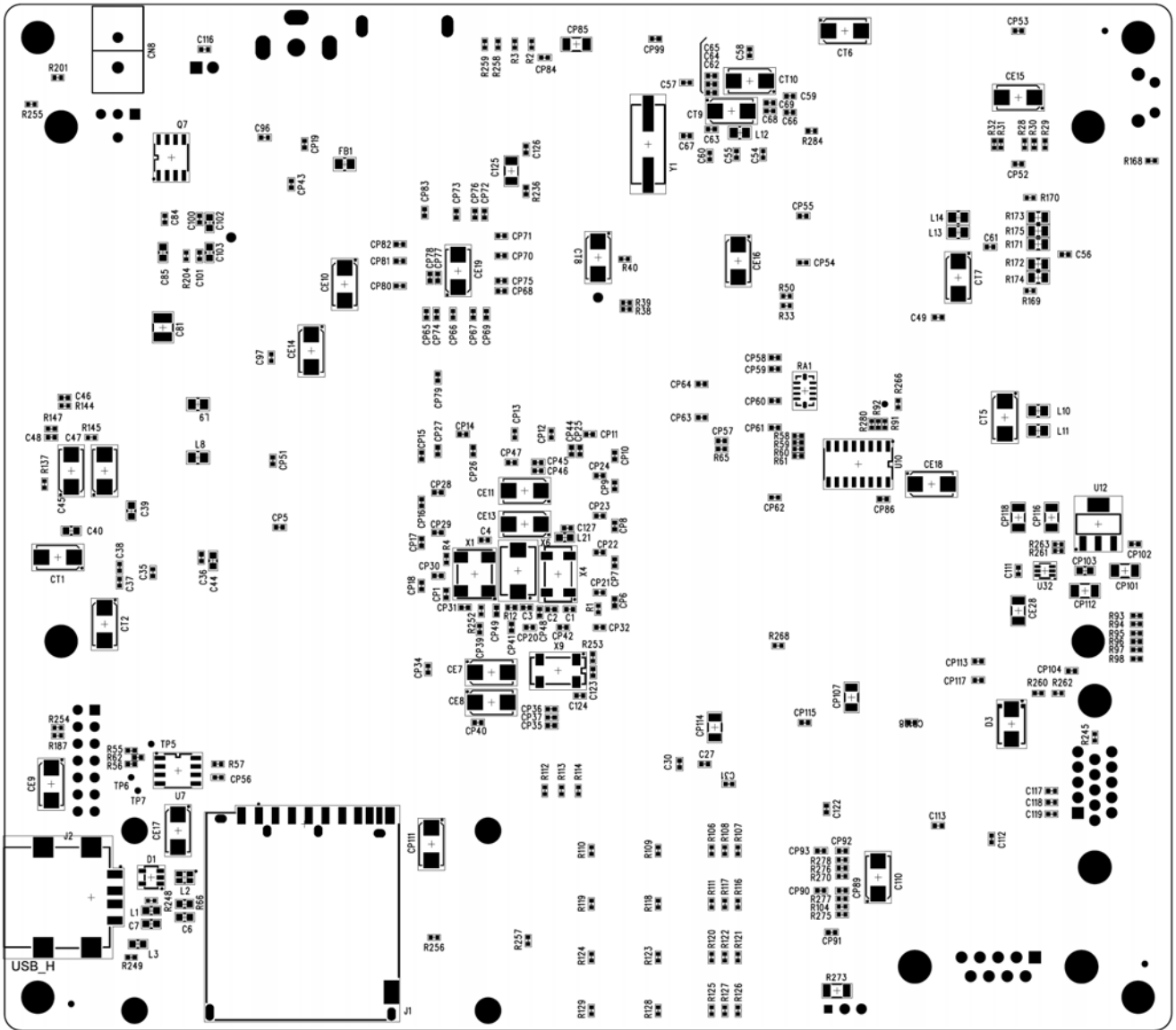

Figure 11-2: Component Placement (Bottom Layer)

Chapter 12. Additional Information

For details on how to use High-performance Embedded Workshop (HEW), refer to the HEW manual available on the CD or installed in the Manual Navigator.

For information about the SH7264 microcontrollers refer to the *SH7264 Group Hardware Manual*

For information about the SH7264 assembly language, refer to the *SH2A, SH2A-FPU Software Manual*

For information about the E10A Emulator, please refer to the *E10A-USB Emulator User's Manual*

Online technical support and information is available at: www.renesas.com/renesas_starter_kits

Technical Contact Details

America: techsupport.rta@renesas.com

Europe: tools.support.eu@renesas.com

Japan: csc@renesas.com

General information on Renesas Microcontrollers can be found on the Renesas website at: www.renesas.com

Renesas Starter Kit2+ for SH7264

User's Manual

Publication Date Rev.1.00 25.JAN.2010

Published by: Renesas Technology Europe Ltd.
Duke's Meadow, Millboard Road, Bourne End
Buckinghamshire SL8 5FH, United Kingdom

©2010 Renesas Technology Europe and Renesas Solutions Corp., All Rights Reserved.

Renesas Starter Kit2+ for SH7264 User's Manual



Renesas Electronics Corporation

1753, Shimonumabe, Nakahara-ku, Kawasaki-shi, Kanagawa 211-8668 Japan

REG10J0171-0100