

To our customers,

---

## Old Company Name in Catalogs and Other Documents

---

On April 1<sup>st</sup>, 2010, NEC Electronics Corporation merged with Renesas Technology Corporation, and Renesas Electronics Corporation took over all the business of both companies. Therefore, although the old company name remains in this document, it is a valid Renesas Electronics document. We appreciate your understanding.

Renesas Electronics website: <http://www.renesas.com>

April 1<sup>st</sup>, 2010  
Renesas Electronics Corporation

Issued by: Renesas Electronics Corporation (<http://www.renesas.com>)

Send any inquiries to <http://www.renesas.com/inquiry>.

## Notice

1. All information included in this document is current as of the date this document is issued. Such information, however, is subject to change without any prior notice. Before purchasing or using any Renesas Electronics products listed herein, please confirm the latest product information with a Renesas Electronics sales office. Also, please pay regular and careful attention to additional and different information to be disclosed by Renesas Electronics such as that disclosed through our website.
2. Renesas Electronics does not assume any liability for infringement of patents, copyrights, or other intellectual property rights of third parties by or arising from the use of Renesas Electronics products or technical information described in this document. No license, express, implied or otherwise, is granted hereby under any patents, copyrights or other intellectual property rights of Renesas Electronics or others.
3. You should not alter, modify, copy, or otherwise misappropriate any Renesas Electronics product, whether in whole or in part.
4. Descriptions of circuits, software and other related information in this document are provided only to illustrate the operation of semiconductor products and application examples. You are fully responsible for the incorporation of these circuits, software, and information in the design of your equipment. Renesas Electronics assumes no responsibility for any losses incurred by you or third parties arising from the use of these circuits, software, or information.
5. When exporting the products or technology described in this document, you should comply with the applicable export control laws and regulations and follow the procedures required by such laws and regulations. You should not use Renesas Electronics products or the technology described in this document for any purpose relating to military applications or use by the military, including but not limited to the development of weapons of mass destruction. Renesas Electronics products and technology may not be used for or incorporated into any products or systems whose manufacture, use, or sale is prohibited under any applicable domestic or foreign laws or regulations.
6. Renesas Electronics has used reasonable care in preparing the information included in this document, but Renesas Electronics does not warrant that such information is error free. Renesas Electronics assumes no liability whatsoever for any damages incurred by you resulting from errors in or omissions from the information included herein.
7. Renesas Electronics products are classified according to the following three quality grades: "Standard", "High Quality", and "Specific". The recommended applications for each Renesas Electronics product depends on the product's quality grade, as indicated below. You must check the quality grade of each Renesas Electronics product before using it in a particular application. You may not use any Renesas Electronics product for any application categorized as "Specific" without the prior written consent of Renesas Electronics. Further, you may not use any Renesas Electronics product for any application for which it is not intended without the prior written consent of Renesas Electronics. Renesas Electronics shall not be in any way liable for any damages or losses incurred by you or third parties arising from the use of any Renesas Electronics product for an application categorized as "Specific" or for which the product is not intended where you have failed to obtain the prior written consent of Renesas Electronics. The quality grade of each Renesas Electronics product is "Standard" unless otherwise expressly specified in a Renesas Electronics data sheets or data books, etc.

"Standard": Computers; office equipment; communications equipment; test and measurement equipment; audio and visual equipment; home electronic appliances; machine tools; personal electronic equipment; and industrial robots.

"High Quality": Transportation equipment (automobiles, trains, ships, etc.); traffic control systems; anti-disaster systems; anti-crime systems; safety equipment; and medical equipment not specifically designed for life support.

"Specific": Aircraft; aerospace equipment; submersible repeaters; nuclear reactor control systems; medical equipment or systems for life support (e.g. artificial life support devices or systems), surgical implantations, or healthcare intervention (e.g. excision, etc.), and any other applications or purposes that pose a direct threat to human life.

8. You should use the Renesas Electronics products described in this document within the range specified by Renesas Electronics, especially with respect to the maximum rating, operating supply voltage range, movement power voltage range, heat radiation characteristics, installation and other product characteristics. Renesas Electronics shall have no liability for malfunctions or damages arising out of the use of Renesas Electronics products beyond such specified ranges.
9. Although Renesas Electronics endeavors to improve the quality and reliability of its products, semiconductor products have specific characteristics such as the occurrence of failure at a certain rate and malfunctions under certain use conditions. Further, Renesas Electronics products are not subject to radiation resistance design. Please be sure to implement safety measures to guard them against the possibility of physical injury, and injury or damage caused by fire in the event of the failure of a Renesas Electronics product, such as safety design for hardware and software including but not limited to redundancy, fire control and malfunction prevention, appropriate treatment for aging degradation or any other appropriate measures. Because the evaluation of microcomputer software alone is very difficult, please evaluate the safety of the final products or system manufactured by you.
10. Please contact a Renesas Electronics sales office for details as to environmental matters such as the environmental compatibility of each Renesas Electronics product. Please use Renesas Electronics products in compliance with all applicable laws and regulations that regulate the inclusion or use of controlled substances, including without limitation, the EU RoHS Directive. Renesas Electronics assumes no liability for damages or losses occurring as a result of your noncompliance with applicable laws and regulations.
11. This document may not be reproduced or duplicated, in any form, in whole or in part, without prior written consent of Renesas Electronics.
12. Please contact a Renesas Electronics sales office if you have any questions regarding the information contained in this document or Renesas Electronics products, or if you have any other inquiries.

(Note 1) "Renesas Electronics" as used in this document means Renesas Electronics Corporation and also includes its majority-owned subsidiaries.

(Note 2) "Renesas Electronics product(s)" means any product developed or manufactured by or for Renesas Electronics.

To all our customers

---

## **Regarding the change of names mentioned in the document, such as Hitachi Electric and Hitachi XX, to Renesas Technology Corp.**

---

The semiconductor operations of Mitsubishi Electric and Hitachi were transferred to Renesas Technology Corporation on April 1st 2003. These operations include microcomputer, logic, analog and discrete devices, and memory chips other than DRAMs (flash memory, SRAMs etc.) Accordingly, although Hitachi, Hitachi, Ltd., Hitachi Semiconductors, and other Hitachi brand names are mentioned in the document, these names have in fact all been changed to Renesas Technology Corp. Thank you for your understanding. Except for our corporate trademark, logo and corporate statement, no changes whatsoever have been made to the contents of the document, and these changes do not constitute any alteration to the contents of the document itself.

Renesas Technology Home Page: <http://www.renesas.com>

Renesas Technology Corp.  
Customer Support Dept.  
April 1, 2003

## Cautions

Keep safety first in your circuit designs!

1. Renesas Technology Corporation puts the maximum effort into making semiconductor products better and more reliable, but there is always the possibility that trouble may occur with them. Trouble with semiconductors may lead to personal injury, fire or property damage.  
Remember to give due consideration to safety when making your circuit designs, with appropriate measures such as (i) placement of substitutive, auxiliary circuits, (ii) use of nonflammable material or (iii) prevention against any malfunction or mishap.

Notes regarding these materials

1. These materials are intended as a reference to assist our customers in the selection of the Renesas Technology Corporation product best suited to the customer's application; they do not convey any license under any intellectual property rights, or any other rights, belonging to Renesas Technology Corporation or a third party.
2. Renesas Technology Corporation assumes no responsibility for any damage, or infringement of any third-party's rights, originating in the use of any product data, diagrams, charts, programs, algorithms, or circuit application examples contained in these materials.
3. All information contained in these materials, including product data, diagrams, charts, programs and algorithms represents information on products at the time of publication of these materials, and are subject to change by Renesas Technology Corporation without notice due to product improvements or other reasons. It is therefore recommended that customers contact Renesas Technology Corporation or an authorized Renesas Technology Corporation product distributor for the latest product information before purchasing a product listed herein.  
The information described here may contain technical inaccuracies or typographical errors. Renesas Technology Corporation assumes no responsibility for any damage, liability, or other loss rising from these inaccuracies or errors.  
Please also pay attention to information published by Renesas Technology Corporation by various means, including the Renesas Technology Corporation Semiconductor home page (<http://www.renesas.com>).
4. When using any or all of the information contained in these materials, including product data, diagrams, charts, programs, and algorithms, please be sure to evaluate all information as a total system before making a final decision on the applicability of the information and products. Renesas Technology Corporation assumes no responsibility for any damage, liability or other loss resulting from the information contained herein.
5. Renesas Technology Corporation semiconductors are not designed or manufactured for use in a device or system that is used under circumstances in which human life is potentially at stake. Please contact Renesas Technology Corporation or an authorized Renesas Technology Corporation product distributor when considering the use of a product contained herein for any specific purposes, such as apparatus or systems for transportation, vehicular, medical, aerospace, nuclear, or undersea repeater use.
6. The prior written approval of Renesas Technology Corporation is necessary to reprint or reproduce in whole or in part these materials.
7. If these products or technologies are subject to the Japanese export control restrictions, they must be exported under a license from the Japanese government and cannot be imported into a country other than the approved destination.  
Any diversion or reexport contrary to the export control laws and regulations of Japan and/or the country of destination is prohibited.
8. Please contact Renesas Technology Corporation for further details on these materials or the products contained therein.

# SH7751 CPU Board HS7751STC01H

User's Manual

## Cautions

1. Hitachi neither warrants nor grants licenses of any rights of Hitachi's or any third party's patent, copyright, trademark, or other intellectual property rights for information contained in this document. Hitachi bears no responsibility for problems that may arise with third party's rights, including intellectual property rights, in connection with use of the information contained in this document.
2. Products and product specifications may be subject to change without notice. Confirm that you have received the latest product standards or specifications before final design, purchase or use.
3. Hitachi makes every attempt to ensure that its products are of high quality and reliability. However, contact Hitachi's sales office before using the product in an application that demands especially high quality and reliability or where its failure or malfunction may directly threaten human life or cause risk of bodily injury, such as aerospace, aeronautics, nuclear power, combustion control, transportation, traffic, safety equipment or medical equipment for life support.
4. Design your application so that the product is used within the ranges guaranteed by Hitachi particularly for maximum rating, operating supply voltage range, heat radiation characteristics, installation conditions and other characteristics. Hitachi bears no responsibility for failure or damage when used beyond the guaranteed ranges. Even within the guaranteed ranges, consider normally foreseeable failure rates or failure modes in semiconductor devices and employ systemic measures such as fail-safes, so that the equipment incorporating Hitachi product does not cause bodily injury, fire or other consequential damage due to operation of the Hitachi product.
5. This product is not designed to be radiation resistant.
6. No one is permitted to reproduce or duplicate, in any form, the whole or part of this document without written approval from Hitachi.
7. Contact Hitachi's sales office for any questions regarding this document or Hitachi semiconductor products.

# IMPORTANT INFORMATION

## READ FIRST

- **READ this user's manual before using this CPU board.**
- **KEEP the user's manual handy for future reference.**

**Do not attempt to use the CPU board until you fully understand its mechanism.**

### **CPU Board:**

Throughout this document, the term "CPU board" shall be defined as the following products produced only by Hitachi, Ltd. excluding all subsidiary products.

- CPU board
- Serial cable
- AC power cable
- AC power adapter

The user system or a host computer is not included in this definition.

### **Purpose of the CPU Board:**

This CPU board is a software and hardware development tool for systems employing the Hitachi microcomputer SH7751. Simple debugging functions such as debugging, performance evaluation, and development of the user system including the SH7751 are enabled by connecting the CPU board to a host computer. In addition, expansion boards can be installed in the slots; therefore, memory and I/O can be expanded. However, this CPU board must not be installed in user products to be used as part of the user products; it is limited to debugging and evaluation of user systems. This CPU board must only be used for the above purpose.

### **Limited Applications:**

This CPU board is not authorized for use in MEDICAL, atomic energy, aeronautical or space technology applications without consent of the appropriate officer of a Hitachi sales company. Such use includes, but is not limited to, use in life support systems. Buyers of this CPU board must notify the relevant Hitachi sales offices before planning to use the product in such applications.

### **Improvement Policy:**

Hitachi, Ltd. (including its subsidiaries, hereafter collectively referred to as Hitachi) pursues a policy of continuing improvement in design, performance, and safety of the CPU board. Hitachi reserves the right to change, wholly or partially, the specifications, design, user's manual, and other documentation at any time without notice.

### **Target User of the CPU Board:**

This CPU board should only be used by those who have carefully read and thoroughly understood the information and restrictions contained in the user's manual. Do not attempt to use the CPU board until you fully understand its mechanism.

It is highly recommended that first-time users be instructed by users that are well versed in the operation of the CPU board.

## **LIMITED WARRANTY**

Hitachi warrants its CPU board to be manufactured in accordance with published specifications and free from defects in material and/or workmanship. Hitachi, at its option, will repair or replace any CPU board returned intact to the factory, transportation charges prepaid, which Hitachi, upon inspection, determine to be defective in material and/or workmanship. The foregoing shall constitute the sole remedy for any breach of Hitachi's warranty. See the Hitachi warranty booklet for details on the warranty period. This warranty extends only to you, the original Purchaser. It is not transferable to anyone who subsequently purchases the CPU board from you. Hitachi is not liable for any claim made by a third party or made by you for a third party.

## **DISCLAIMER**

HITACHI MAKES NO WARRANTIES, EITHER EXPRESS OR IMPLIED, ORAL OR WRITTEN, EXCEPT AS PROVIDED HEREIN, INCLUDING WITHOUT LIMITATION THEREOF, WARRANTIES AS TO MARKETABILITY, MERCHANTABILITY, FITNESS FOR ANY PARTICULAR PURPOSE OR USE, OR AGAINST INFRINGEMENT OF ANY PATENT. IN NO EVENT SHALL HITACHI BE LIABLE FOR ANY DIRECT, INCIDENTAL OR CONSEQUENTIAL DAMAGES OF ANY NATURE, OR LOSSES OR EXPENSES RESULTING FROM ANY DEFECTIVE CPU BOARD, THE USE OF ANY CPU BOARD, OR ITS DOCUMENTATION, EVEN IF ADVISED OF THE POSSIBILITY OF SUCH DAMAGES. EXCEPT AS EXPRESSLY STATED OTHERWISE IN THIS WARRANTY, THIS CPU BOARD IS SOLD "AS IS", AND YOU MUST ASSUME ALL RISK FOR THE USE AND RESULTS OBTAINED FROM THE CPU BOARD.

**State Law:**

Some states do not allow the exclusion or limitation of implied warranties or liability for incidental or consequential damages, so the above limitation or exclusion may not apply to you. This warranty gives you specific legal rights, and you may have other rights which may vary from state to state.

**The Warranty is Void in the Following Cases:**

Hitachi shall have no liability or legal responsibility for any problems caused by misuse, abuse, misapplication, neglect, improper handling, installation, repair or modifications of the CPU board without Hitachi's prior written consent or any problems caused by the user system.

**All Rights Reserved:**

This user's manual and CPU board are copyrighted and all rights are reserved by Hitachi. No part of this user's manual, all or part, may be reproduced or duplicated in any form, in hard-copy or machine-readable form, by any means available without Hitachi's prior written consent.

**Other Important Things to Keep in Mind:**

1. Circuitry and other examples described herein are meant merely to indicate the characteristics and performance of Hitachi's semiconductor products. Hitachi assumes no responsibility for any intellectual property claims or other problems that may result from applications based on the examples described herein.
2. No license is granted by implication or otherwise under any patents or other rights of any third party or Hitachi.

**Figures:**

Some figures in this user's manual may show items different from your actual system.

**Limited Anticipation of Danger:**

Hitachi cannot anticipate every possible circumstance that might involve a potential hazard. The warnings in this user's manual and on the CPU board are therefore not all inclusive. Therefore, you must use the CPU board safely at your own risk.

# SAFETY PAGE

## READ FIRST

- **READ** this user's manual before using this CPU board.
- **KEEP** the user's manual handy for future reference.

Do not attempt to use the CPU board until you fully understand its mechanism.

## DEFINITION OF SIGNAL WORDS



This is the safety alert symbol. It is used to alert you to potential personal injury hazards. Obey all safety messages that follow this symbol to avoid possible injury or death.



**DANGER** indicates an imminently hazardous situation which, if not avoided, will result in death or serious injury.



**WARNING** indicates a potentially hazardous situation which, if not avoided, could result in death or serious injury.



**CAUTION** indicates a potentially hazardous situation which, if not avoided, may result in minor or moderate injury.



**CAUTION** used without the safety alert symbol indicates a potentially hazardous situation which, if not avoided, may result in property damage.

**NOTE** emphasizes essential information.

## **WARNING**

**Observe the precautions listed below. Failure to do so will result in a FIRE HAZARD and will damage the user system and the CPU board or will result in PERSONAL INJURY. The USER PROGRAM will be LOST.**

- 1. Always satisfy the power supply conditions which are described in the manual. Ensure that there are no short circuits between VCC and GND. Do not apply voltage that is outside the guaranteed range.**
- 2. Always switch OFF the CPU board and the user system before connecting or disconnecting any CABLES, connectors, or jumpers.**
- 3. When turning on the CPU board or the user system, take care that conductive material does not touch the CPU board or the user system.**
- 4. Check that the pin numbers on the connectors of the CPU board and those on the user system are correctly aligned before connecting the CPU board and the user system.**



# Preface

Thank you for purchasing the CPU board for Hitachi's SH7751 microcomputer.

The CPU board is an efficient development tool for software and hardware of systems based on Hitachi's SH7751 microcomputer.

This manual explains the functions and method of operation of the CPU board.

Section 1, Overview, describes the hardware system configuration and explains environment settings to enable board use.

Section 2, Preparations Before Use, explains procedures for using the CPU board, HDI installation, various connections, and the power supply specifications.

Section 3, Tutorial, introduces the major HDI features while demonstrating methods for loading and debugging a C language program.

Section 4, Descriptions of Windows, describes each of the windows used in the HDI.

Section 5, CPU Board Specifications, explains the specifications of the CPU board, the memory map, interfaces with external equipment, and CPU board initialization.

Section 6, Notes and Troubleshooting, explains important information regarding use and gives suggestions for troubleshooting.

Section 7, Creation of User Interrupt Handlers, explains how to create an original interrupt handler routine.

Please read this manual completely in order to gain a thorough understanding of this product's functions and performance.

The text appearing in the various windows of the HDI may differ from those appearing in this manual depending on the language of the OS being used. The figures appearing in this manual are for the Microsoft® Windows® 98.

## Related Manuals

- SH7751 Hardware Manual
- SH4 Programming Manual
- SH Series Cross Assembler User's Manual
- SH Series C Compiler User's Manual
- SH Series Simulator/Debugger User's Manual
- Hitachi Debugging Interface User's Manual (available in the CD-R supplied with this CPU board)

When connecting an E10A emulator to the CPU board, the following manual should also be read.

- SH7751 E10A Emulator User's Manual

Notes: 1. IBM PC is a registered trademark of International Business Machines Corporation in the United States.

2. Microsoft<sup>®</sup>, Windows<sup>®</sup>, and WindowsNT<sup>®</sup> are registered trademarks of Microsoft Corporation in the United States and/or other countries.

# Contents

Section 1 Overview.....	1
1.1 Features.....	1
1.2 System Configuration .....	2
1.3 Warnings.....	3
1.4 Components .....	4
1.5 CD-R Contents.....	5
1.6 Environmental Conditions .....	6
Section 2 Preparation before Use .....	7
2.1 CPU Board Preparation .....	7
2.2 HDI Installation .....	8
2.3 HDI Uninstallation.....	9
2.4 Connecting Cables .....	10
2.5 Connecting the User Expansion Board .....	12
2.6 Connecting the Compact PCI Backplane.....	13
2.7 Switches.....	16
2.8 Jumpers .....	17
2.9 Power Supply .....	20
2.9.1 Power-Supply Specifications.....	20
2.9.2 Connecting the Power Supply Cable .....	21
Section 3 Tutorial.....	23
3.1 Introduction .....	23
3.2 Running the HDI.....	24
3.3 [HDI] Window .....	26
3.4 Setting up the CPU Board.....	27
3.5 Setting the [Monitor Setup] Dialog Box .....	27
3.6 Downloading the Tutorial Program .....	29
3.6.1 Downloading the Tutorial Program .....	29
3.6.2 Displaying the Source Program .....	30
3.7 Setting the Software Breakpoint .....	32
3.8 Setting Registers .....	33
3.9 Executing the Program .....	35
3.10 Reviewing Breakpoints.....	38
3.11 Viewing Memory.....	39
3.12 Watching Variables.....	40
3.13 Stepping Through a Program.....	43
3.13.1 Executing [Step In] Command .....	44
3.13.2 Executing [Step Out] Command.....	45

3.13.3	Executing [Step Over] Command.....	47
3.14	Displaying Local Variables .....	49
3.15	Software Break Function .....	50
3.16	Run Time Count Function .....	53
3.17	Saving a Session .....	58
3.18	What Next?.....	59
<b>Section 4 Descriptions of Windows.....</b>		<b>61</b>
4.1	HDI Windows.....	61
4.2	Descriptions of Each Window .....	64
4.2.1	[Monitor Setup] Dialog Box.....	64
4.2.3	[Add/Edit Breakpoint] Dialog Box.....	68
4.2.4	[System Status] Window .....	69
4.2.5	[Run Time Count Condition] Dialog Box .....	71
4.2.6	[Cache Control] Dialog Box.....	72
4.2.7	[Simulated I/O Window] Window.....	73
4.2.8	[Command Line] Window.....	74
<b>Section 5 CPU Board Specifications .....</b>		<b>75</b>
5.1	Block Diagram.....	75
5.2	Specifications.....	76
5.3	Memory Map.....	78
5.4	External Interface .....	80
5.4.1	Serial Interface.....	80
5.4.2	EPROM Socket Interface .....	82
5.4.3	LAN Interface.....	83
5.4.4	User Expansion Board Interface.....	86
5.4.5	PCI Interface.....	96
5.5	On-Board Registers .....	101
5.6	E10A Emulator Interface.....	106
5.7	On-Board LEDs .....	108
5.8	Parts Layout.....	110
5.9	Initialization.....	114
5.9.1	Initializing Resources .....	114
5.9.2	Procedure for Making Initial Settings of the CPU Bus State Controller (BSC) ..	116
5.9.3	Initial Settings of CPU Bus State Controller (BSC) .....	117
<b>Section 6 Notes and Troubleshooting.....</b>		<b>123</b>
6.1	Notes.....	123
6.2	Troubleshooting.....	129
<b>Section 7 Creation of User Interrupt Handlers .....</b>		<b>131</b>
7.1	Creation of User Interrupt Handlers .....	131
7.2	User Program Using SCIF .....	133
7.2.1	Creation of SCIF Driver .....	133

7.2.2 SCIF-Related Register Settings ..... 133  
7.3 Sample Program..... 136

## Figure

Figure 1.1	CPU Board, External View .....	1
Figure 1.2	CPU Board System Configuration .....	2
Figure 2.1	CPU Board Preparation Flow Chart.....	7
Figure 2.2	[Setup.exe] Icon .....	8
Figure 2.3	Start Menu.....	9
Figure 2.4	E10A User System Interface Cable Connection .....	10
Figure 2.5	Serial Interface Cable Connection .....	11
Figure 2.6	AC Adapter Connection.....	11
Figure 2.7	User Expansion Board Connection (CN1).....	12
Figure 2.8	Compact PCI Backplane Connection.....	13
Figure 2.9	Spacer Removal .....	14
Figure 2.10	Front Panel Attachment .....	15
Figure 2.11	Switch Location .....	16
Figure 2.12	Jumper Insertion.....	19
Figure 2.13	Power-Supply Specifications .....	20
Figure 2.14	Power-Supply Section Block Diagram .....	20
Figure 2.15	Front View of Power Supply Connector .....	21
Figure 2.16	AC Power Supply Adapter Connection .....	22
Figure 3.1	[Start] Menu .....	24
Figure 3.2	[Select Session] Dialog Box.....	24
Figure 3.3	Power Supply Confirmation Message Box .....	25
Figure 3.4	[HDI] Window .....	26
Figure 3.5	[Monitor Setup] Dialog Box .....	27
Figure 3.6	[Load Program] Dialog Box .....	29
Figure 3.7	[HDI] Message Box .....	29
Figure 3.8	[Open] Dialog Box.....	30
Figure 3.9	[Program] Window (Displaying the Source Program).....	31
Figure 3.10	[Program] Window (Setting a Software Breakpoint).....	32
Figure 3.11	[Registers] Window .....	33
Figure 3.12	[Register] Dialog Box (PC).....	34
Figure 3.13	[Register] Dialog Box (SP) .....	34
Figure 3.14	[Go] Button .....	35
Figure 3.15	[Program] Window (Break Status).....	35
Figure 3.16	[System Status] Window.....	36
Figure 3.17	[Breakpoints] Window .....	38
Figure 3.18	[Open Memory Window] Dialog Box .....	39
Figure 3.19	[Word Memory] Window .....	39
Figure 3.20	[Instant Watch] Dialog Box .....	40
Figure 3.21	[Watch Window] Window (Displaying the Array).....	41
Figure 3.22	[Add Watch] Dialog Box .....	41
Figure 3.23	[Watch Window] Window (Displaying the Variable) .....	42
Figure 3.24	[Watch Window] Window (Displaying Array Elements).....	42

Figure 3.25	[Program] Window (Step Execution).....	43
Figure 3.26	[Step In] Button.....	44
Figure 3.27	[Program] Window (Step In) .....	44
Figure 3.28	[Step Out] Button .....	45
Figure 3.29	[Program] Window (Step Out).....	45
Figure 3.30	[Program] Window (Step In → Step In).....	46
Figure 3.31	[Step Over] Button .....	47
Figure 3.32	[Program] Window (Before Step Over Execution).....	47
Figure 3.33	[Program] Window (Step Over).....	48
Figure 3.34	[Locals] Window.....	49
Figure 3.35	[Breakpoints] Window (Before setting software break) .....	50
Figure 3.36	[Add/Edit Breakpoint] Dialog Box .....	51
Figure 3.37	[Breakpoints] Window (Software Breakpoint Setting).....	51
Figure 3.38	[Program] Window at Execution Stop (Software Break).....	52
Figure 3.39	Displayed Contents of the [System Status] Window (Software Break).....	52
Figure 3.40	[Program] Window (Break before Run Time Count) .....	53
Figure 3.41	[System Status] Window (Run Time Count Disabled) .....	54
Figure 3.42	[Run Time Count Condition] Dialog Box.....	54
Figure 3.43	[Program] Window (Stopped at a Breakpoint after Run Time Count) .....	56
Figure 3.44	[System Status] Window (Run Time Count Result) .....	57
Figure 4.1	[Monitor Setup] Dialog Box .....	64
Figure 4.2	[Breakpoints] Window .....	66
Figure 4.3	[Add/Edit Breakpoint] Dialog Box .....	68
Figure 4.4	[System Status] Window .....	69
Figure 4.5	[Run Time Count Condition] Window.....	71
Figure 4.6	[Cache Control] Dialog Box .....	72
Figure 4.7	[Simulated I/O Window] Window .....	74
Figure 5.1	Block Diagram of the CPU board .....	75
Figure 5.2	CPU Board Memory Map .....	79
Figure 5.3	Connection to Host Computer.....	81
Figure 5.4	Serial Interface Connector Pin Arrangement .....	82
Figure 5.5	User Expansion Board Interface Connector CN1 Pin Arrangement.....	87
Figure 5.6	Bus Release Timing (1).....	90
Figure 5.7	Bus Release Timing (2).....	91
Figure 5.8	Example of CKIO Terminal Resistor Connection.....	92
Figure 5.9	Configuration of User Expansion Board Interface Circuit (CN1)-1 .....	93
Figure 5.10	Configuration of User Expansion Board Interface Circuit (CN1)-2 .....	94
Figure 5.11	Configuration of User Expansion Board Interface Circuit (CN1)-3 .....	95
Figure 5.12	Compact PCI interface CN19 and CN20 Pin Arrangements.....	96
Figure 5.13	CPU Board Power Supply Lines .....	100
Figure 5.14	Reset Signal Lines.....	100
Figure 5.15	Hitachi-UDI Port Connector (CN23) Pin Arrangement.....	106
Figure 5.16	LED Locations .....	108
Figure 5.17	Parts Layout (Mounting Side).....	113
Figure 5.18	Procedure for Setting BSC Settings .....	116

Figure 6.1	Error Message Displayed at Exception (Instruction TLB Miss Exception).....	124
Figure 6.2	Dialog Box Indicating Breakpoint Cannot Be Set .....	124
Figure 6.3	Power-on Reset Input Message Box .....	125
Figure 6.4	Manual Reset Input Message Box.....	125
Figure 7.1	Executing the Sample Program.....	136

## Table

Table 1.1	CPU Board Component List .....	4
Table 1.2	CD-R Contents .....	5
Table 1.3	Environmental Conditions .....	6
Table 1.4	Operating Environments .....	6
Table 2.1	Default Installation Directory .....	8
Table 2.2	Switch Specifications .....	16
Table 2.3	Jumper Settings .....	18
Table 3.1	Tutorial Program Configuration.....	23
Table 3.2	Check Items When HDI Cannot Be Initiated.....	25
Table 3.3	Setting the [Monitor Setup] Dialog Box .....	28
Table 3.4	Contents of the [System Status] Window.....	37
Table 3.5	Step Option .....	43
Table 3.6	Items Set in [Run Time Count Condition] Dialog Box.....	55
Table 3.7	Selectable Measurement Units .....	55
Table 4.1	HDI Window Menus and Related Manual Entries.....	61
Table 4.2	[Monitor Setup] Dialog Box Page.....	65
Table 4.3	[Breakpoints] Window Display Items.....	67
Table 4.4	[Breakpoints] Window Pop-up Menu Operation .....	67
Table 4.5	[Add/Edit Breakpoint] Dialog Box Items .....	68
Table 4.6	[System Status] Window Display Items.....	70
Table 4.7	[Run Time Count Condition] Dialog Box Items .....	71
Table 4.8	Selectable Measurement Units .....	72
Table 4.9	[Cache Control] Dialog Box Items.....	73
Table 5.1	External Specifications.....	76
Table 5.2	Pin Assignment of the Serial Interface Connector .....	80
Table 5.3	Serial Interface Specifications.....	81
Table 5.4	Pin Assignment of the EPROM Socket.....	83
Table 5.5	LAN91C96 LAN Controller Register Specifications (Bank 0).....	84
Table 5.6	LAN91C96 LAN Controller Register Specifications (Bank 1).....	84
Table 5.7	LAN91C96 LAN Controller Register Specifications (Bank 2).....	85
Table 5.8	LAN91C96 LAN Controller Register Specifications (Bank 3).....	85
Table 5.9	LAN91C96 LAN Controller Register Specifications (Bank 4).....	86
Table 5.10	Pin Assignment of User Expansion Board Interface Connector CN1 .....	88
Table 5.11	AC Specifications.....	91
Table 5.12	Compact PCI Interface J1 Connector (CN19) Pin Assignments .....	97
Table 5.13	Compact PCI Interface J2 Connector (CN20) Pin Assignments .....	98
Table 5.14	On-Board Registers .....	101
Table 5.15	Hitachi-UDI Port Connector (CN23) Pin Assignment.....	107
Table 5.16	LED Functions .....	109
Table 5.17	List of Uninstalled Parts .....	110
Table 5.18	Resource Initialization .....	114
Table 6.1	Watchdog Timer Register .....	127

Table 6.2	Register Initial Value Settings .....	129
Table 7.1	Interrupt Causes and Branch Addresses for User Interrupt Handlers .....	131
Table 7.2	HALT Break Destination Address .....	133
Table 7.3	Sample Program Files .....	137
Table 7.4	Sections for the Sample Program.....	137
Table 7.5	Interrupt Processing in the Sample Program.....	138

# Section 1 Overview

## 1.1 Features

The SH7751 CPU board (hereafter, referred to as the CPU board) supports the evaluation of the functions and performance of the Hitachi SH7751 microcomputer, and the development and evaluation of systems that incorporate the SH7751.

The features of this CPU board are as follows:

- Supports user expansion boards  
Has an expansion connector for I/O of signals conforming to the SH7751 external bus specifications, to which an expansion board developed by the user to increase memory and I/O can be connected and evaluated.
- Supports the maximum operating frequency  
Allows evaluation at 167 MHz and 83.5 MHz, which are the maximum internal and external operating frequencies of the SH7751, respectively.
- Host Interface  
For interfacing with IBM PC compatible as the host computer, one channel of serial interface (that conforms to RS-232C) is provided. The Hitachi Debugging Interface (HDI) is also provided as host interface software.
- Enables user-program evaluation  
Up to 63.5 Mbytes of a user program can be loaded into the user memory and be evaluated.
- Support for compact PCI interface  
The SH7751 provides PCI interface functions. The CPU board outputs the on-chip PCI bus interface signals through the compact PCI connector. This interface conforms to the PICMG2.0 rev.2.1, and the CPU board functions can be easily expanded by connecting to a standard backplane.

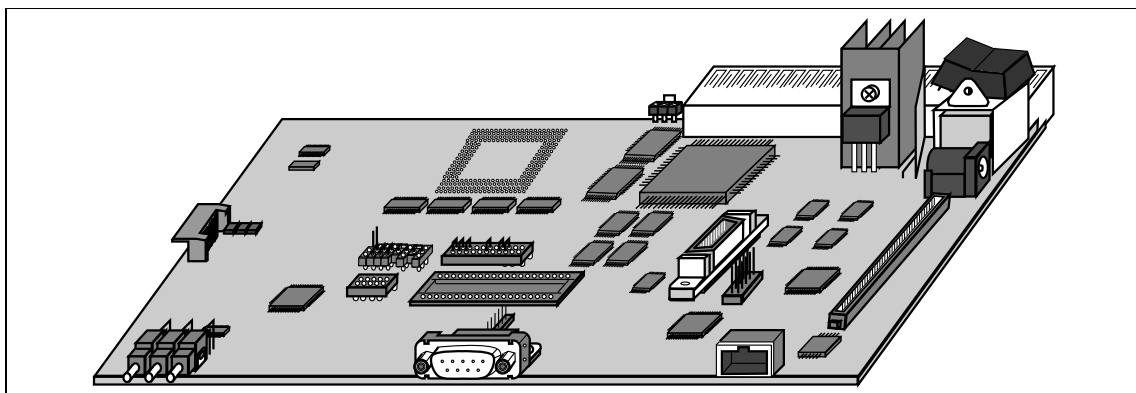

Figure 1.1 CPU Board, External View

## 1.2 System Configuration

The system configuration of the CPU board is shown in figure 1.2.

The following items are required to use the CPU board.

- IBM PC compatible machine: One for the monitor command input and output.
- One serial interface cable: Use the provided cable.
- One AC power supply adapter: Use the provided adapter.
- One AC power supply cable: Use the provided power cable.

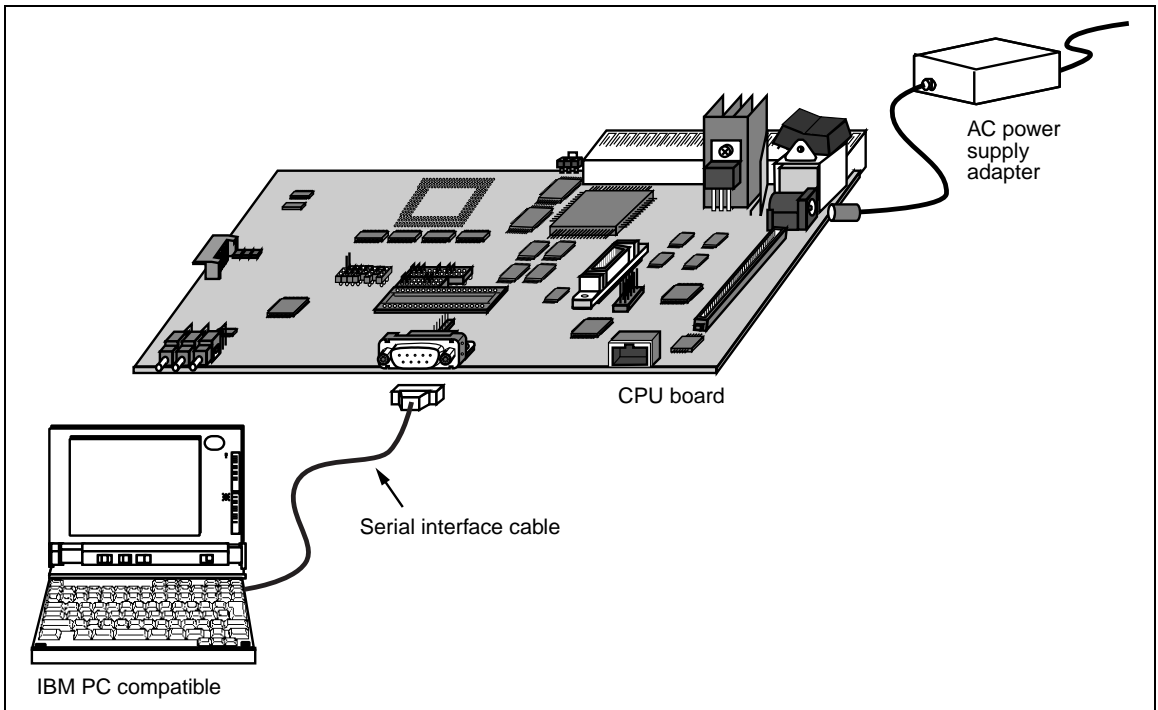

**Figure 1.2 CPU Board System Configuration**

### 1.3 Warnings

## CAUTION







**READ the following warnings before using the CPU board. Incorrect operation will damage the user system and the CPU board. The USER PROGRAM will be LOST.**

1. Check all components against the component list after unpacking the CPU board.
2. Never place heavy objects on the CPU board.
3. Protect the CPU board from excessive impacts and stresses. For details, refer to section 1.6, Environmental Conditions.
4. Do not connect any cable or connector other than specified ones to the CPU board.
5. When moving the host computer or user expansion board, take care not to vibrate or damage the CPU board.
6. After connecting the cable, check that it is connected correctly. For details, refer to section 2, Preparation before Use.
7. Supply power to the connected equipment after connecting all cables. Cables must not be connected or removed while the power is on.

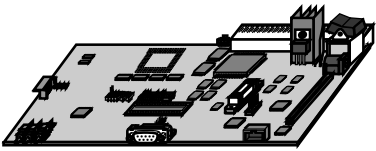
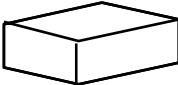
## 1.4 Components

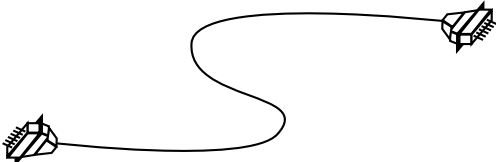
Table 1.1 lists the components of the CPU board. Check all components after unpacking.

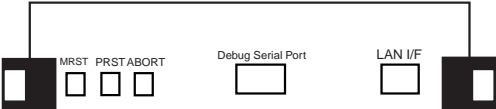
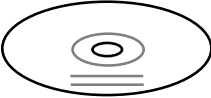
**Table 1.1 CPU Board Component List**

Item	View	Quantity	Remarks
CPU board		1	One printed circuit board
AC power supply adapter		1	
AC power supply cable		1	
Serial interface cable		1	
Jumper		4	
Front panel		1	For use in a compact PCI rack. provided with handles
CD-R (HDI installer)		1	One CD-R; Model number HS7751STC01SR (contains CPU board manual and HDI manual)
SH7751 CPU Board Installation Guide		2	One Japanese version and one English version; Japanese: HS7751STC01HJ-P, English: HS7751STC01HE-P

## 1.5 CD-R Contents

The supplied CD-R includes software and user's manuals for the SH7751 CPU board as listed in table 1.2.

**Table 1.2 CD-R Contents**

Directory	File Name	Contents	Remarks
\Setup	Setup.exe	HDI installer	
\Manuals\Japanese	HS7751STC01HJ.pdf	SH7751 CPU Board User's Manual	PDF document in Japanese Type No.: HS7751STC01HJ
\Manuals\Japanese	HS6400DIIW5SJ.pdf	Hitachi Debugging Interface User's Manual	PDF document in Japanese Type No.: HS6400DIIW5SJ
\Manuals\English	HS7751STC01HE.pdf	SH7751 CPU Board User's Manual	PDF document in English Type No.: HS7751STC01HE
\Manuals\English	HS6400DIIW5SE.pdf	Hitachi Debugging Interface User's Manual	PDF document in English Type No.: HS6400DIIW5SE
\Pdf_read\Japanese	Ar40jpn.exe	Acrobat® Reader installer	Japanese version
\Pdf_read\English	Ar40eng.exe	Acrobat® Reader installer	English version

Note: To read a PDF document, use the Acrobat® Reader.

## 1.6 Environmental Conditions

### CAUTION

Observe the conditions listed in tables 1.3 and 1.4 when using the CPU board. Failure to do so will damage the user expansion board and the CPU board. The USER PROGRAM will be LOST.

**Table 1.3 Environmental Conditions**

Item	Specifications
Temperature	Operating: +10°C to +35°C Storage: -10°C to +50°C
Humidity	Operating: 35% RH to 80% RH, no condensation Storage: 35% RH to 80% RH, no condensation
Vibration	Operating: 2.45 m/s <sup>2</sup> max. Storage: 4.9 m/s <sup>2</sup> max. Transportation: 14.7 m/s <sup>2</sup> max.
Ambient gases	There must be no corrosive gases present

**Table 1.4 Operating Environments**

Item	Description
Host computer	Built-in Pentium or higher-performance CPU (200 MHz or higher recommended); IBM PC or compatible machine.
OS	Windows <sup>®</sup> 95, Windows <sup>®</sup> 98, or Windows NT <sup>®</sup>
Minimum memory capacity	32 Mbytes or more (double of the load module size recommended)
Hard-disk capacity	Installation disk capacity: 5 Mbytes or more. (Prepare an area at least double the memory capacity (four-times or more recommended) as the swap area.)
CD-ROM drive	Required to install the HDI.
Pointing device such as mouse	Connectable to the host computer; compatible with Windows <sup>®</sup> 95, Windows <sup>®</sup> 98, and Windows NT <sup>®</sup> .
Power voltage (AC power supply adapter)	Input: 100 to 240 VAC, 50/60 Hz, 0.6 A max. Output: +5 VDC 5 A

## Section 2 Preparation before Use

### 2.1 CPU Board Preparation

 <b>WARNING</b>
<b>READ the reference sections shaded in figure 2.1 before using the CPU board product. Incorrect operation will damage the CPU board and the user expansion board. The USER PROGRAM will be LOST.</b>

Unpack the CPU board and prepare it for use as follows:

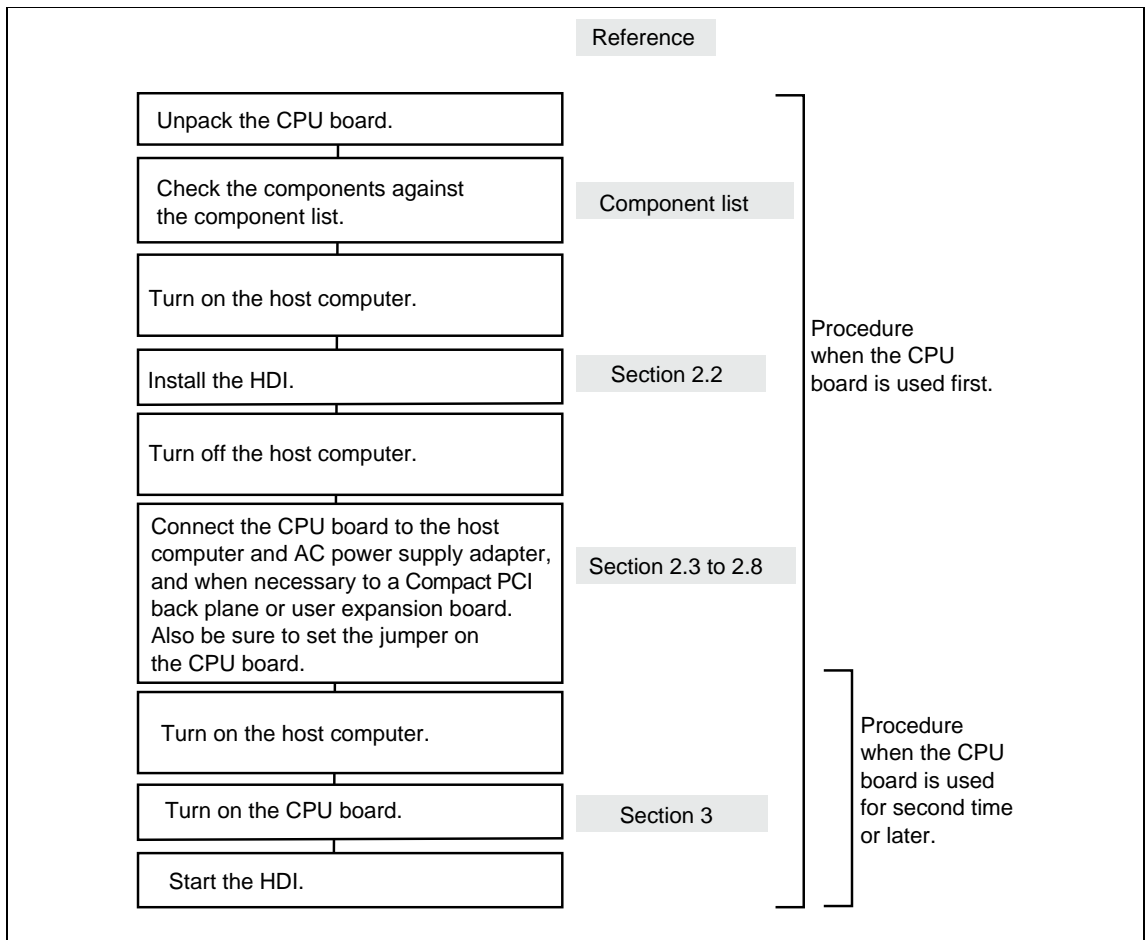

Figure 2.1 CPU Board Preparation Flow Chart

## 2.2 HDI Installation

An example of installing the HDI on an IBM PC compatible machine is described in this section.

Start [Setup.exe] in the \Setup directory of the HDI installer CD-R. If any other application is running, close it before starting the HDI installer.



**Figure 2.2 [Setup.exe] Icon**

This runs the HDI installer. A dialog box will first prompt you to select a language for the installation process. Select a language then continue according to the instructions displayed by the installer.

Note: Under Windows NT<sup>®</sup> 4.0, install the HDI in the administrator mode.

**HDI Installation Directory:** The default directory for installing the HDI depends on whether the Hitachi Embedded Workshop (HEW) has been installed in the host computer, as shown in table 2.1

**Table 2.1 Default Installation Directory**

HEW Program	Default Installation Directory
HEW has not been installed	C:\Hdi5_cb\7751
HEW has been installed (in this example, in C:\HEW)	C:\Hew\Hdi5\Cb\7751

**Backup File:** If another version of HDI has already been installed, a message "The HDI.INI file has already existed. Can it be overwritten?" will be displayed. Clicking [Yes] will make a backup of the existing file in the Backup directory of the installation directory.

When installation is complete, [HDI for SH7751 CPU board] can be selected from the start menu.

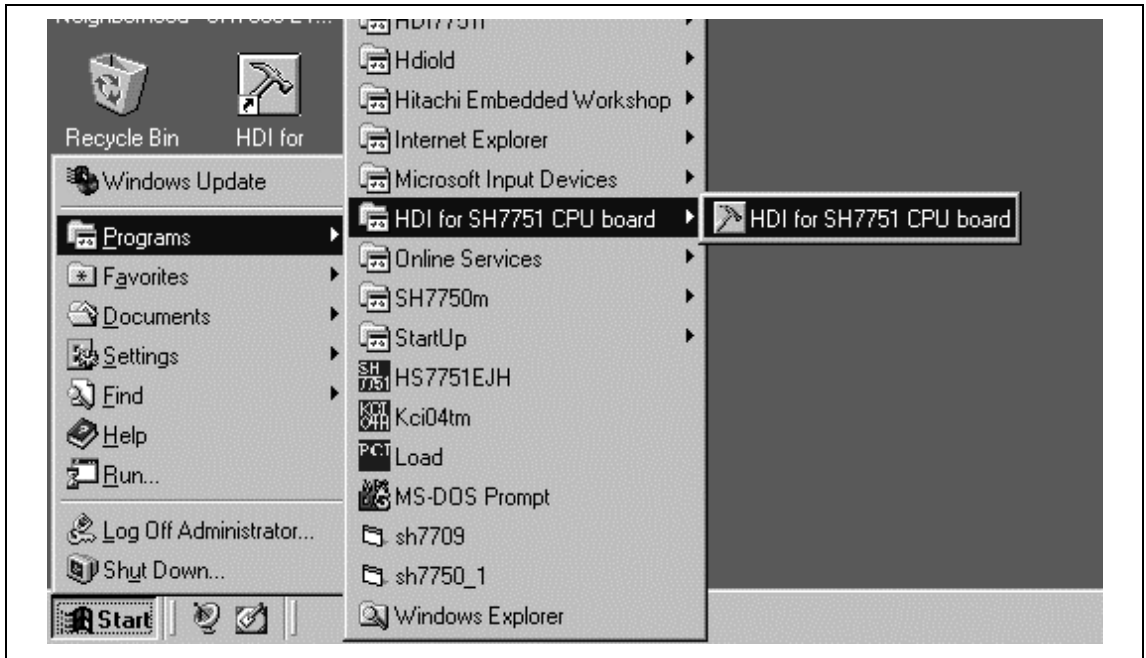

**Figure 2.3 Start Menu**

## **2.3 HDI Uninstallation**

Uninstall the HDI for the SH7751 CPU board as follows:

1. Select [Settings] from the Start menu, then select [Control Panel].
2. Select [Add/Remove Programs].
3. Select [HDI for SH7751 CPU board] from the application list, then click [Add/Remove].
4. A confirmation message will be displayed, and the uninstallation procedure will start.

## 2.4 Connecting Cables

Figures 2.4 to 2.6 show how to connect interface cables to the CPU board.

**⚠ WARNING**

**Always switch OFF the CPU board and the user system before connecting or disconnecting any CABLES, CONNECTORS, or JUMPERS. Failure to do so will result in a FIRE HAZARD and will damage the user system and the CPU board or will result in PERSONAL INJURY. The USER PROGRAM will be LOST.**

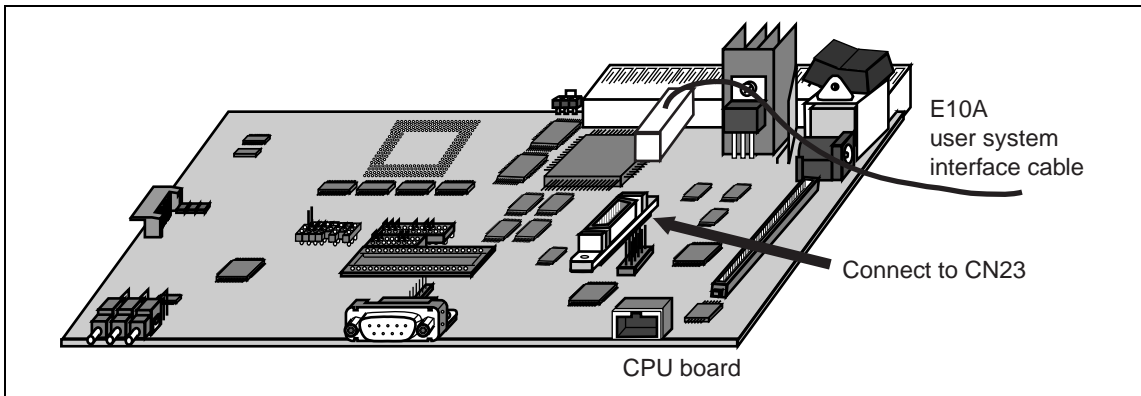

**Figure 2.4 E10A User System Interface Cable Connection**

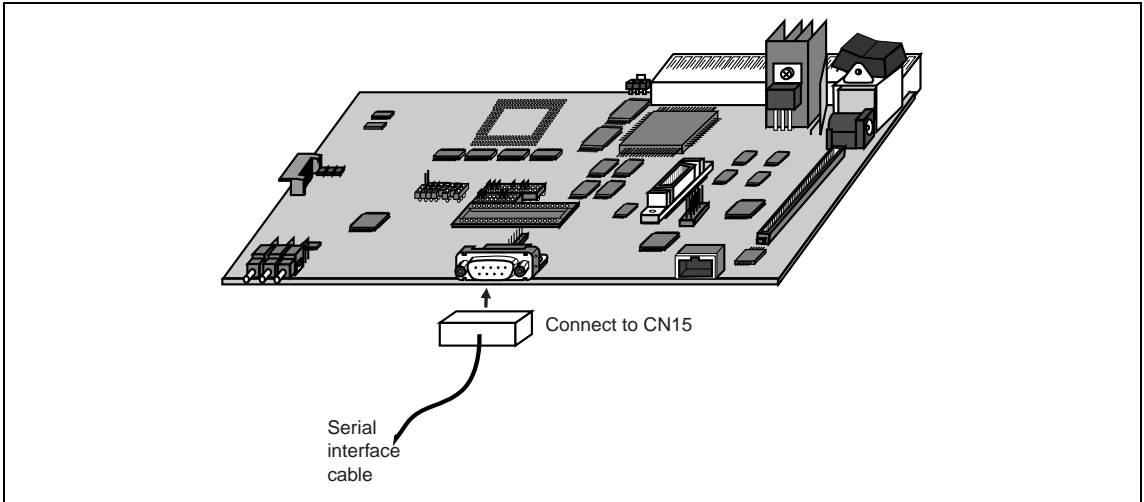

Figure 2.5 Serial Interface Cable Connection

## ! WARNING

**Always switch OFF the CPU board and the user system before connecting or disconnecting any CABLES. Failure to do so will result in a FIRE HAZARD and will damage the user expansion board and the CPU board or will result in PERSONAL INJURY. The USER PROGRAM will be LOST.**

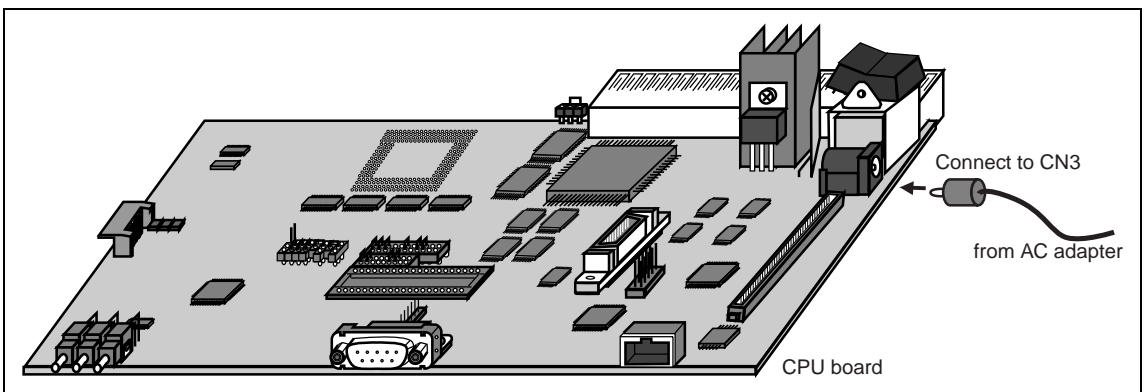



Figure 2.6 AC Adapter Connection

## 2.5 Connecting the User Expansion Board

Figure 2.7 shows how to connect the user expansion board.

 **WARNING**

**Always switch OFF the CPU board and the user system before connecting or disconnecting any CABLES, CONNECTORS, or JUMPERS. Failure to do so will result in a FIRE HAZARD and will damage the user system and the CPU board or will result in PERSONAL INJURY. The USER PROGRAM will be LOST.**

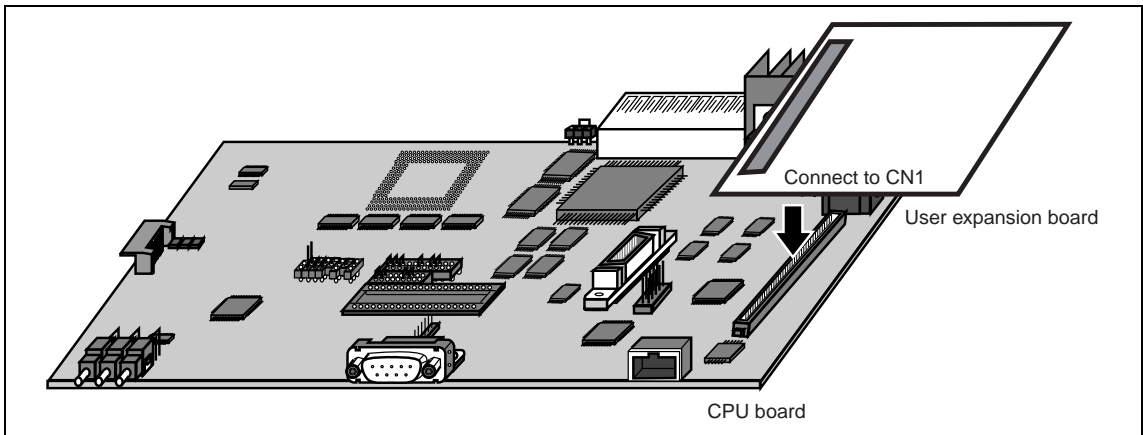

**Figure 2.7 User Expansion Board Connection (CN1)**

## 2.6 Connecting the Compact PCI Backplane

Figure 2.8 shows how to connect the compact PCI backplane.

 **WARNING**

**Always switch OFF the CPU board and the user system before connecting or disconnecting any CABLES, CONNECTORS, or JUMPERS. Failure to do so will result in a FIRE HAZARD and will damage the user system and the CPU board or will result in PERSONAL INJURY. The USER PROGRAM will be LOST.**

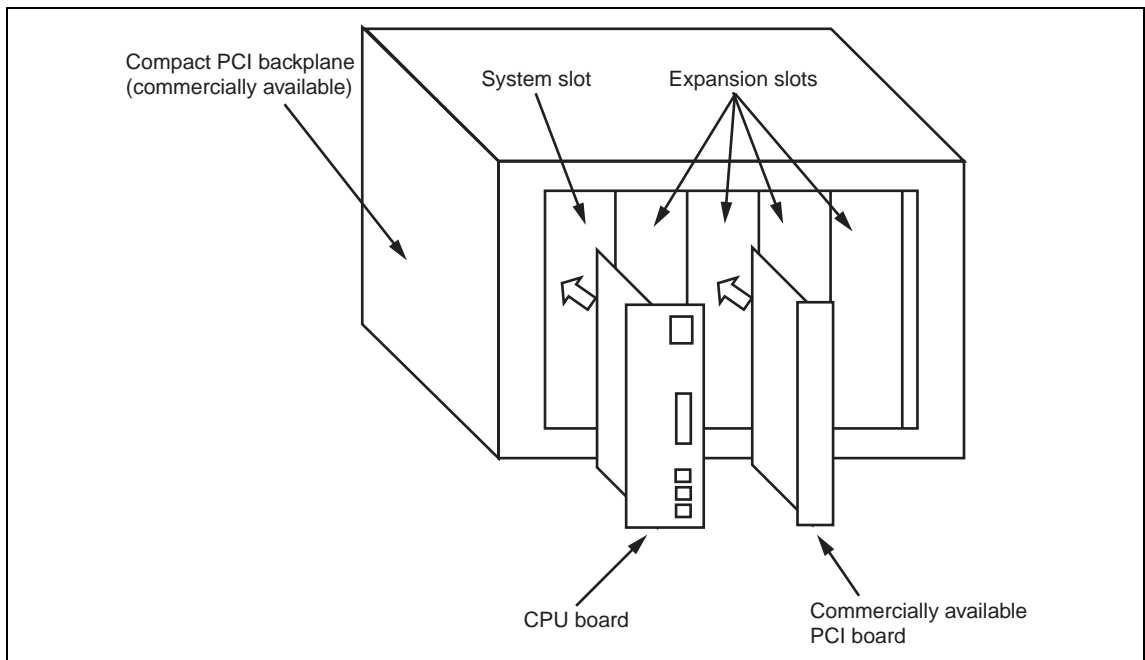
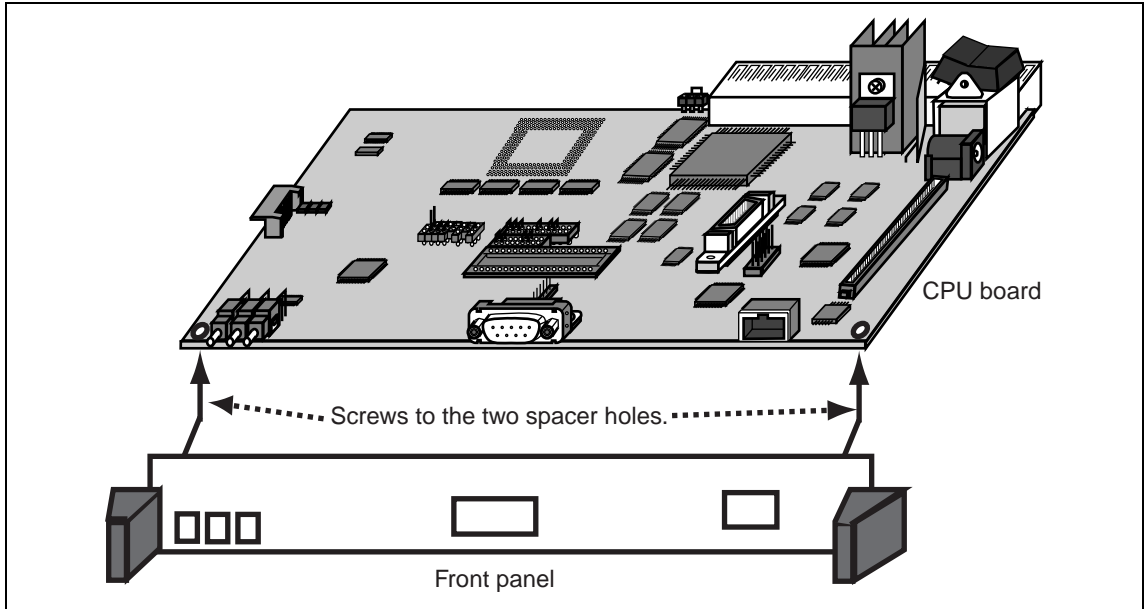

**Figure 2.8 Compact PCI Backplane Connection**

The CPU board can be used as a system board for compact PCI. Install the CPU board in the system board slot of the backplane. The 3.3V, 33MHz, and 32bit interface is supported. Up to four expansion slots can be controlled.

Before installing the CPU board in the backplane, remove the spacers and attach the front panel as shown in figures 2.9 and 2.10. Do not lose the spacers and screws removed.





**Figure 2.10 Front Panel Attachment**

## 2.7 Switches

Table 2.2 lists the switches used in the CPU board and figure 2.11 shows where the switches are located (on the CPU board).

**Table 2.2 Switch Specifications**

Switch	Symbol	Type	Function
Power supply switch	SW1	Rocker switch	Turns on and off the 5 V power supplied to the CPU board. Turn off this switch when connecting to the compact PCI backplane.
Manual reset switch	SW2	Push button (red)	Forcibly initializes the system. Use this switch when the system does not operate correctly, for example, when the user program goes out of control. The BSC settings are not initialized.
Power-on reset switch	SW3	Push button (white)	Forcibly initializes the system. Use this switch when the system does not operate correctly, for example, when the user program goes out of control. The BSC settings are reset to the HDI initial settings.
Abort switch	SW4	Push button (black)	Forcibly aborts the command currently being executed. When this button is pressed while the user program is being executed, the CPU board stops execution and returns to the monitor program command wait state.

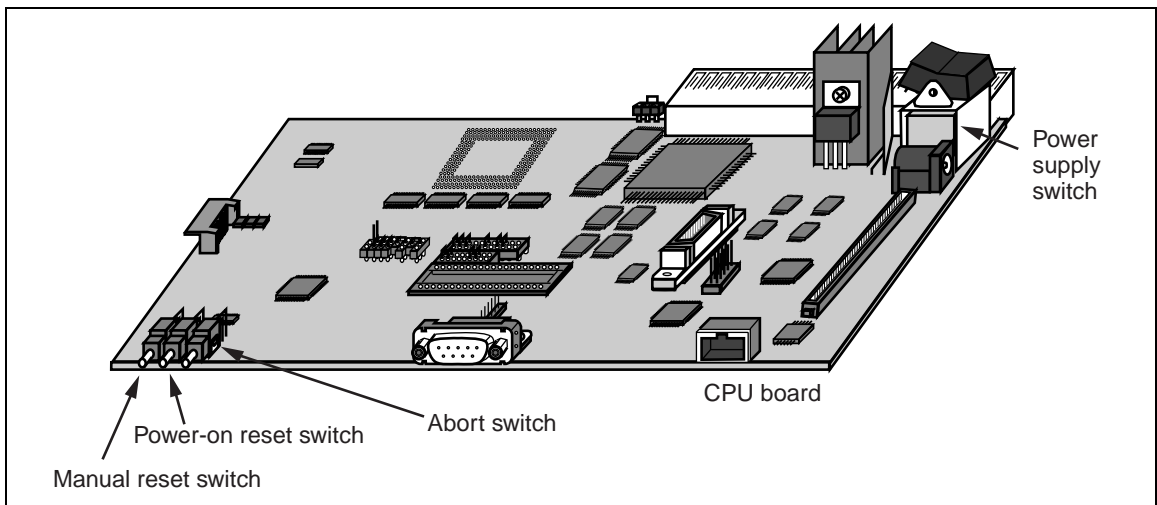

**Figure 2.11 Switch Location**

## 2.8 Jumpers

The CPU board has 33 locations for jumpers: J11 to J16, J21 to J2A, J31 to J36 and J41 to J4B.

- J11 to J16: For test in Hitachi. No jumpers are mounted.
- J21 to J21A: For specifying the CPU board operating mode. J21, J23 and J25 to J27 are mounted.
- J31 to J36: For specifying expansion functions. J35 and J36 are mounted.
- J41 to J4B: For specifying the SH7751 modes. J42, J46, J49, J4A, and J4B are mounted.

Table 2.3 shows jumper settings. In the table, the initial settings at shipment are shaded. The reserved settings must not be used. Figure 2.12 shows how to insert a jumper pin.

### **WARNING**

**Always switch OFF the CPU board and the user system before connecting or disconnecting any CABLES, CONNECTORS, or JUMPERS. Failure to do so will result in a FIRE HAZARD and will damage the user system and the CPU board or will result in PERSONAL INJURY. The USER PROGRAM will be LOST.**

**Table 2.3 Jumper Settings**

Symbol	Function	Setting	Description
J21	Base clock	1-2 closed	Reserved (must not be used)
		2-3 closed	On-board clock (27.8 MHz)
J23	Bus frequency	Closed	CPU internal frequency 167 MHz
			Bus frequency 55.7 MHz
			CPU on-chip module frequency 27.8 MHz
		Open	CPU internal frequency 167 MHz
			Bus frequency 83.5 MHz
			CPU on-chip module frequency 41.8 MHz
J25	Resource for area 0	Closed	EPROM (socket) connected. Flash memory is connected to area 2.
		Open	Flash memory (containing HDI) connected.
J26	Expansion bus area 2	Closed	Area 2 released to the user expansion board interface
		Open	Area 2 cannot be used
J27	Expansion bus area 4	Closed	Area 4 released to the user expansion board interface
		Open	Area 4 cannot be used
J35	PCI clock	1-2 closed	On-board clock (33 MHz)
		2-3 closed	Reserved (must not be used)
J36	Serial interface baud rate	Closed	57,600 bit/s
		Open	115,200 bit/s
J42	CPU clock mode	Closed	Clock mode 5
		Open	Reserved (must not be used)
J46	CPU endian	Closed	Big endian
		Open	Little endian
J49	CPU clock source	Closed	Pulse input to EXTAL of CPU
		Open	Reserved (must not be used)
J4A	CPU PCI clock	Closed	Input to PCICLK pin
		Open	Reserved (must not be used)
J4B	CPU PCI function	Closed	PCI function enabled
		Open	PCI function disabled

Note: When the EPROM is selected by J25, area 2 becomes the flash memory area regardless of the J26 setting, and the expansion bus area cannot be accessed in area 2. The CS0 bus width is switched between 32 bits (flash memory is connected) and 16 bits (EPROM is connected) by the J25 setting.

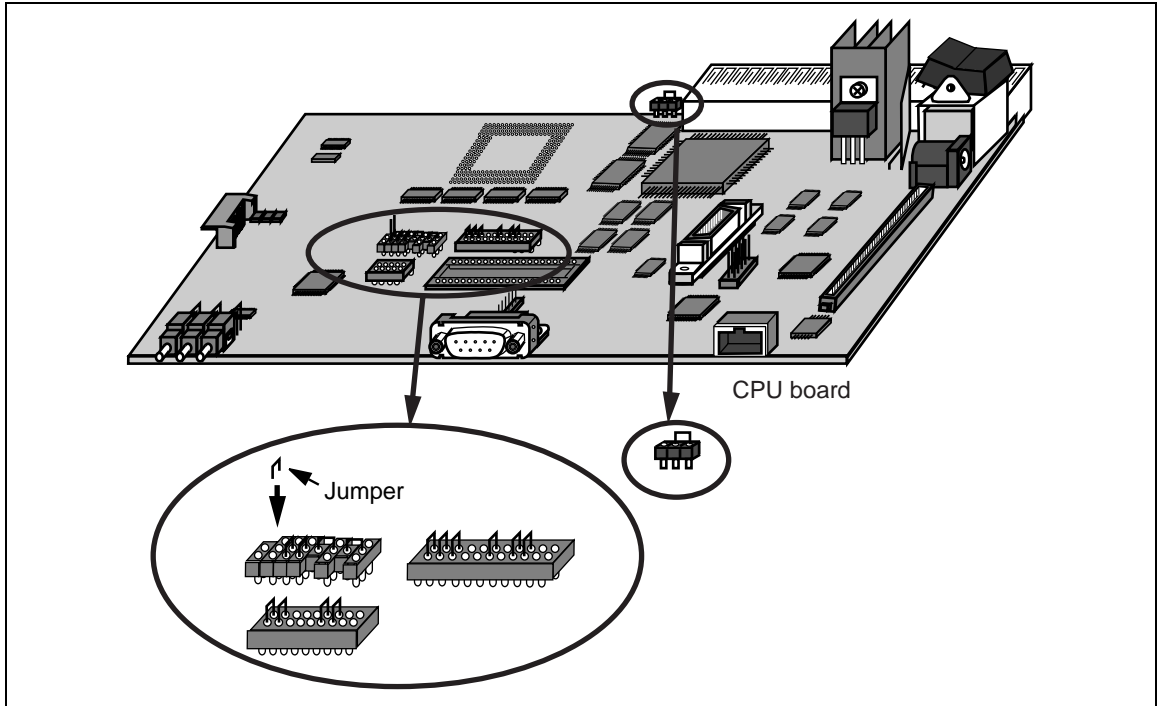

**Figure 2.12 Jumper Insertion**

## 2.9 Power Supply

### 2.9.1 Power-Supply Specifications

Figure 2.13 shows the power-supply specifications, and figure 2.14 shows the block diagram of the power-supply section.

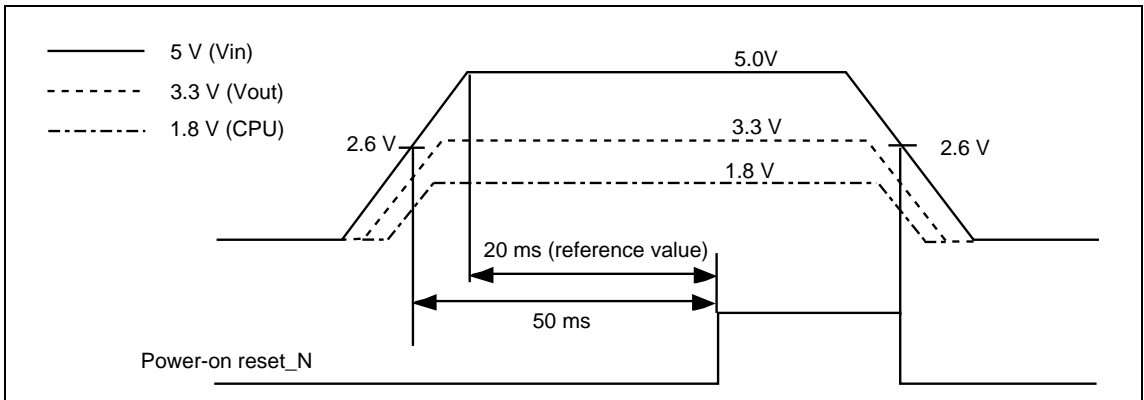

Figure 2.13 Power-Supply Specifications

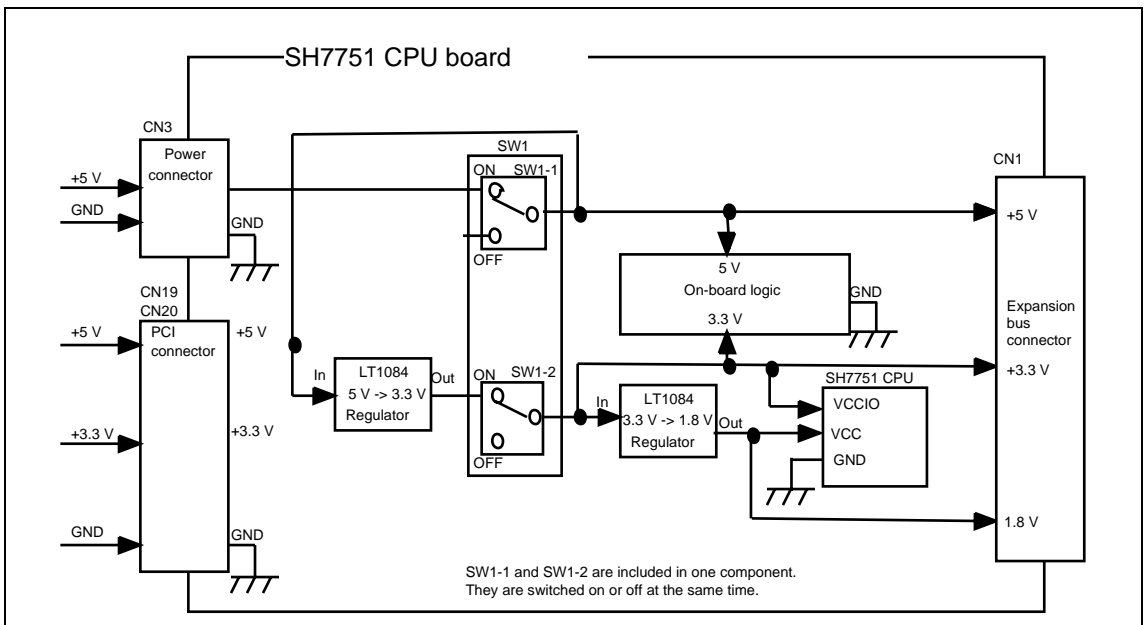

Figure 2.14 Power-Supply Section Block Diagram

## 2.9.2 Connecting the Power Supply Cable

Power should always be supplied to the CPU board using the provided AC power supply adapter and AC power supply cable. The method of connection is shown in figures 2.15 and 2.16.

### WARNING

**Observe the precautions listed below. Failure to do so will result in a FIRE HAZARD and will damage the user system and the CPU board or will result in PERSONAL INJURY. The USER PROGRAM will be LOST.**

- 1. Always use the provided AC power supply adapter.**
- 2. Always switch OFF the CPU board and the user system before connecting or disconnecting any CABLES, CONNECTORS, or JUMPERS.**

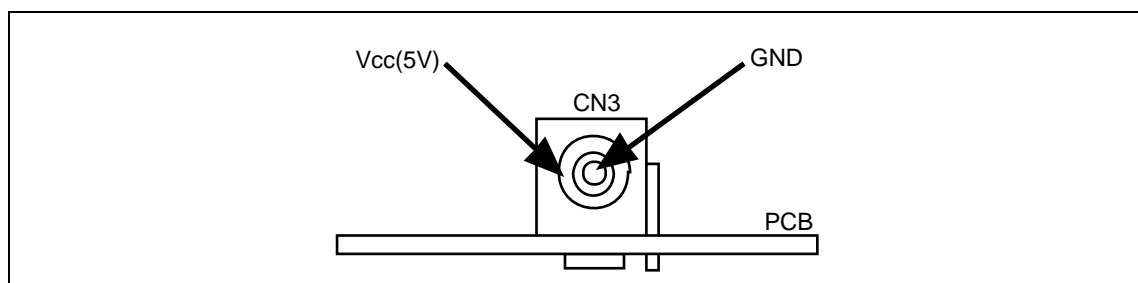
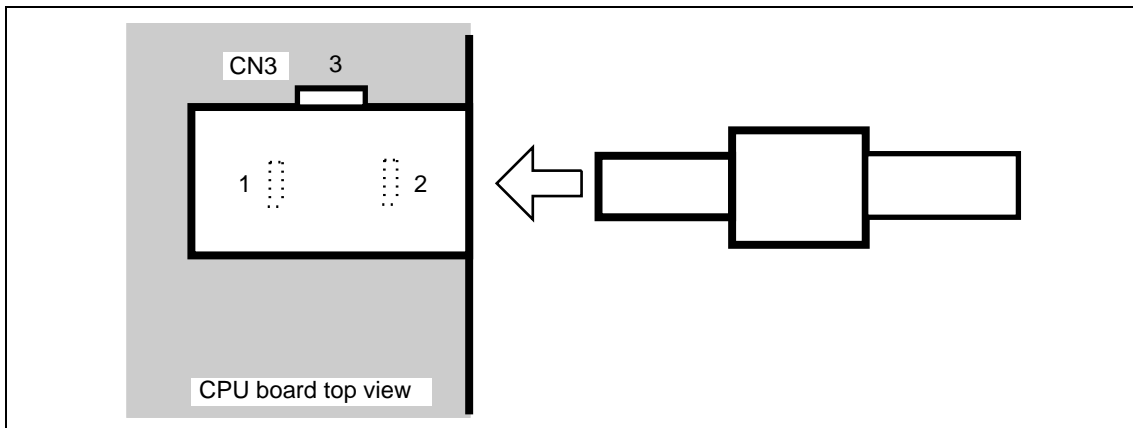

Figure 2.15 Front View of Power Supply Connector



**Figure 2.16 AC Power Supply Adapter Connection**

## Section 3 Tutorial

### 3.1 Introduction

The following describes the main features of the HDI by using a tutorial program.

The tutorial program is based on the C program that sorts ten random data items in ascending or descending order.

The tutorial program is included in the `Sort.c` file in the HDI installer CD-R. The compiled load module is provided in the SYSROF format and is included in the `Sort.abs` file.

The tutorial program is automatically installed when the HDI is installed.

Table 3.1 lists the tutorial program configuration.

**Table 3.1 Tutorial Program Configuration**

Item	Contents
Tutorial file (load module)	(install directory)\Tutorial\Sort.abs
Tutorial file (source file)	(install directory)\Tutorial\Sort.c

This sample program uses the RAM area starting from address H'0C000000. The MMU function is not used.

- Notes:
1. `Sort.abs` operates in big endian. `Sort.abs` must be recompiled to operate in little endian.
  2. The work space for this tutorial program was created using Version 1.1a (Release 3) of Hitachi Embedded Workshop (HEW).
    - Hitachi SH C/C++ compiler version 5.1B
    - Hitachi SH IM OptLinker version 1.1B

## 3.2 Running the HDI

To run the HDI, select the [HDI for SH7751 CPU Board] from the [Start] menu.

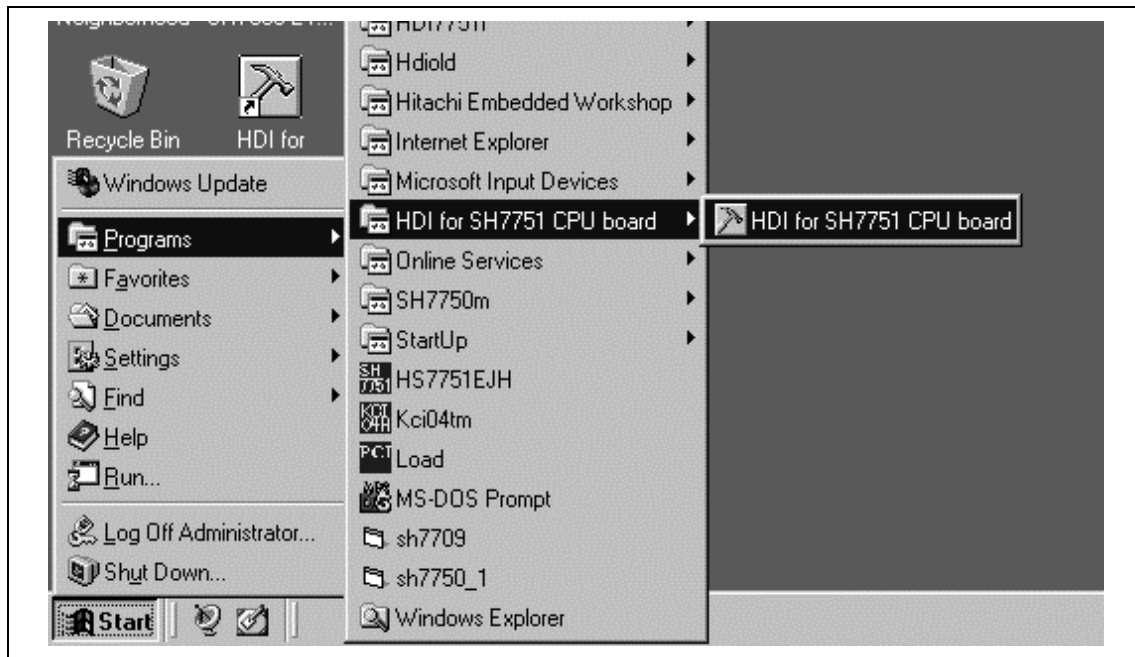

Figure 3.1 [Start] Menu

The [HDI] window will open, then the [Select Session] dialog box will appear. Check that the setting shown in figure 3.2 is complete, and click the [OK] button.

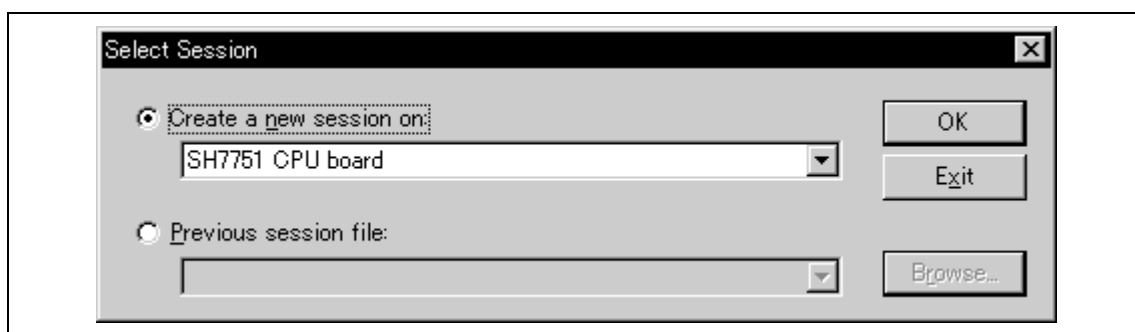
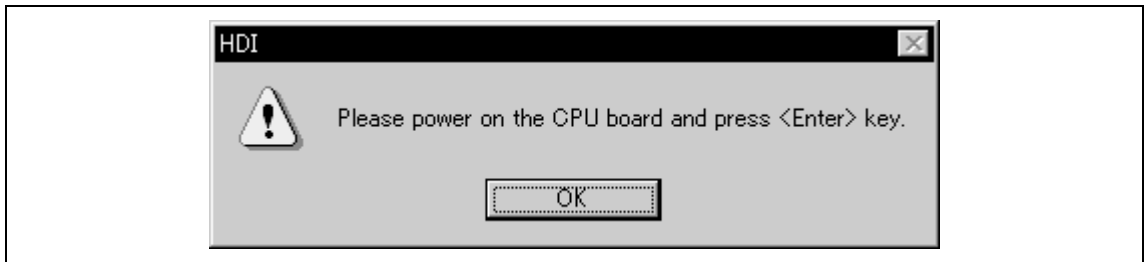

Figure 3.2 [Select Session] Dialog Box

The message box shown in figure 3.3 will appear. Check that the CPU board power is turned on, and click the [OK] button.



**Figure 3.3 Power Supply Confirmation Message Box**

When `Link up` appears in the message box, HDI startup is completed.

If `Link up` does not appear, check the items listed in table 3.2.

**Table 3.2 Check Items When HDI Cannot Be Initiated**

<b>Check Item</b>	<b>Reference in this Manual</b>
Check that the power monitoring LED (D22) on the CPU board is turned on.	Section 5.7
Check that the host computer and the CPU board are correctly connected through a serial cable.	Sections 2.4 and 5.4.1
Check that the port and baud rate are set correctly in the [Monitor Setup] dialog box.	Sections 3.5 and 4.2.1
Check that the jumper pins are correctly inserted into the jumpers on the CPU board.	Section 2.8

### 3.3 [HDI] Window

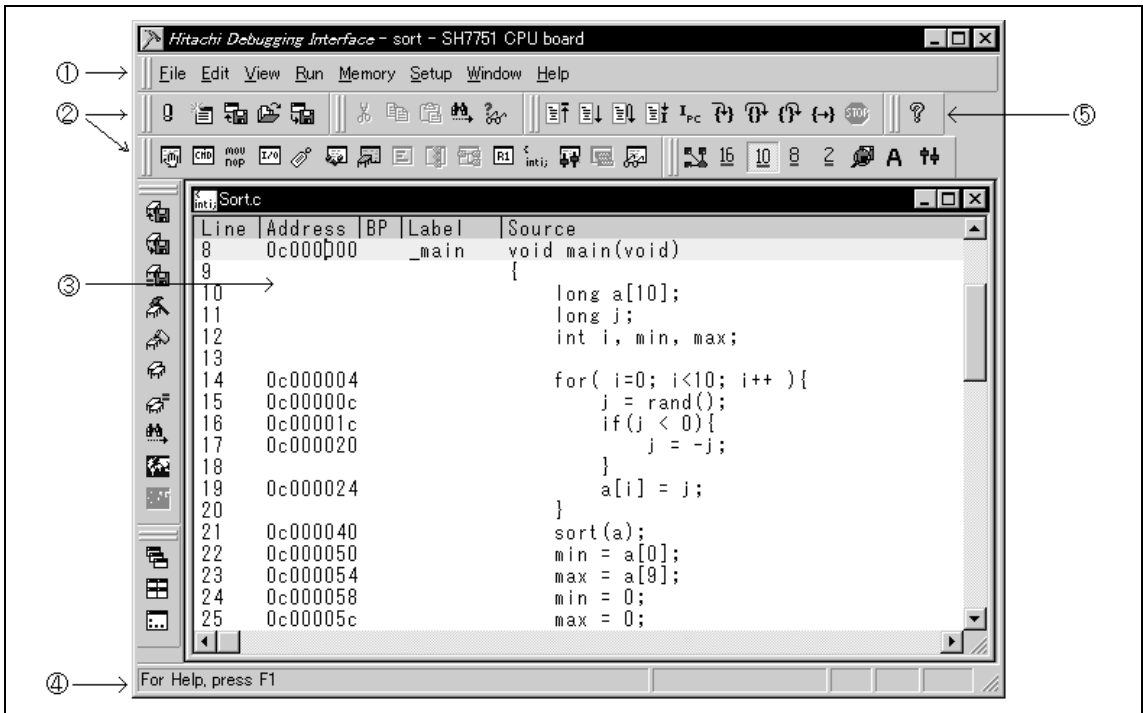

**Figure 3.4 [HDI] Window**

The key features of the HDI are described in section 4, Descriptions of Windows. Numbers in figure 3.4 indicate the following:

1. Menu bar: Gives the user access to the HDI commands for using the HDI debugger.
2. Toolbar: Provides convenient buttons as shortcuts for the most frequently used menu commands.
3. Program window: Displays the source program being debugged.
4. Status bar: Displays the status of the CPU board, and progress information about downloading.
5. [Help] button: Activates on-line help about any features of the HDI user interface.

### 3.4 Setting up the CPU Board

The following conditions can be set up on the CPU board before downloading the program:

- Connection method
- I/O definition file
- Options on program load

The following describes how to set up the CPU board for the tutorial programs.

### 3.5 Setting the [Monitor Setup] Dialog Box

- Select [Configure Platform...] from the [Setup] menu to set configuration. The [Monitor Setup] dialog box is displayed.

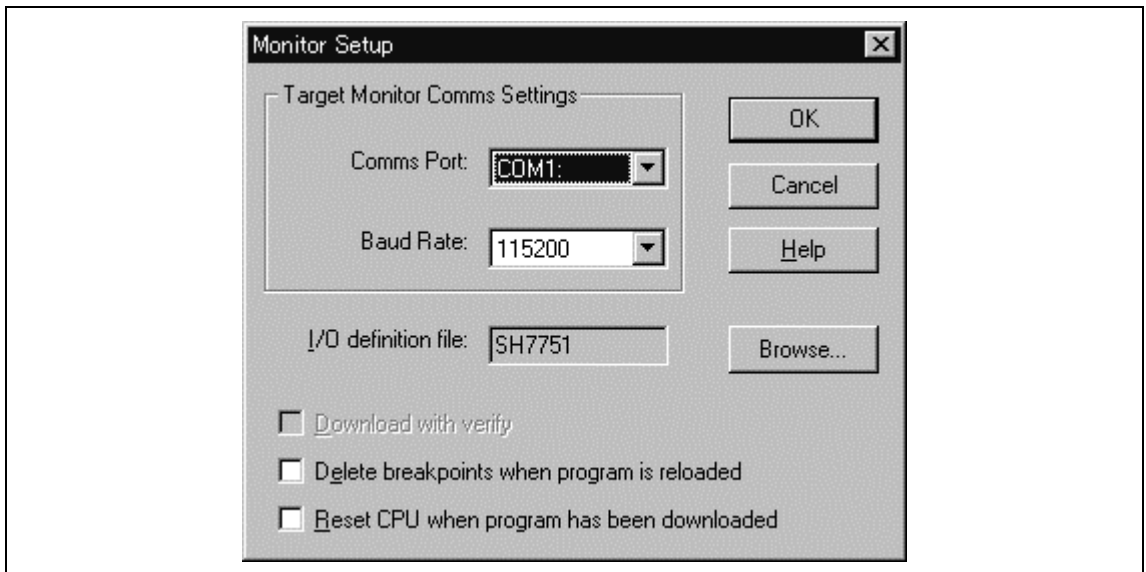

**Figure 3.5 [Monitor Setup] Dialog Box**

- Notes:
1. The I/O register definition file can be selected in this dialog box. Be sure to select a file within the HDI installation directory. Otherwise, the I/O register window will not operate correctly.
  2. The name of the I/O register definition file can consist of up to nine characters. This number does not include the file name's extension.

- Set options as follows:

**Table 3.3 Setting the [Monitor Setup] Dialog Box**

<b>Option</b>	<b>Default</b>	<b>Value</b>
Comms Port:	COM1:	Select from among COM1, COM2, COM3, or COM4 as the host computer serial port.
Baud Rate:	115200	Sets the serial baud rate. Select either 57600 bit/s or 115200 bit/s, to match the setting of jumper J36. Connection is not possible at any other setting.
I/O definition file	SH7751	Sets the I/O register definition file. The SH7751 definition file is set as default. On selecting a file, the [I/O Registers] window (accessed from the [View] menu) can be used to display register information.
Download with verify	--	The CPU board does not support this function (this box cannot be selected).
Delete breakpoints when program is reloaded	Unchecked	When this box is checked, all breakpoints are deleted when a program is reloaded.
Reset CPU when program has been downloaded	Unchecked	When this box is checked, registers are initialized* when a program is loaded. No reset signal is input to the CPU board.

Note: Initialized as follows: PC = H'AC000000, SR = H'600000E0, and VBR = H'A0080000 (big endian) or H'A0100000 (little endian).

- Click the [OK] button.

## 3.6 Downloading the Tutorial Program

### 3.6.1 Downloading the Tutorial Program

Download the object program to be debugged.

- Select [Load Program...] from the [File] menu. The [Load Program] dialog box is displayed. Enter the offset and file name in the [Offset] edit box and [File name] list box as shown in figure 3.6 and click the [Open] button.

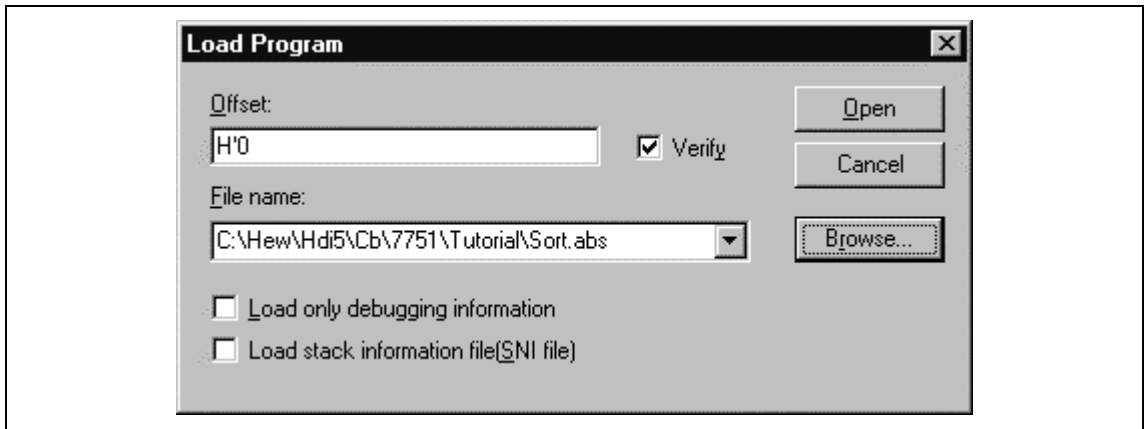

Figure 3.6 [Load Program] Dialog Box

When the file has been loaded, the following message box displays information about the memory areas that have been filled with the program code.

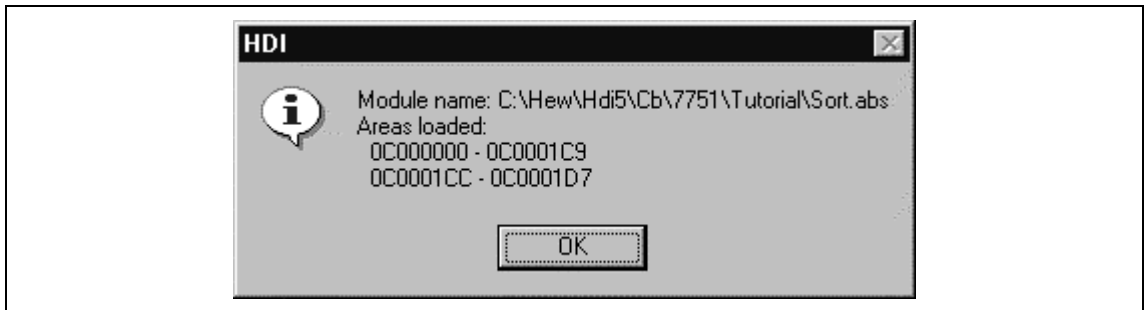

Figure 3.7 [HDI] Message Box

- Click the [OK] button to continue.

### 3.6.2 Displaying the Source Program

The HDI allows the user to debug a program at the source level.

- Select [Source...] from the [View] menu. The [Open] dialog box is displayed.
- Select the C source file that corresponds to the object file the user has loaded.

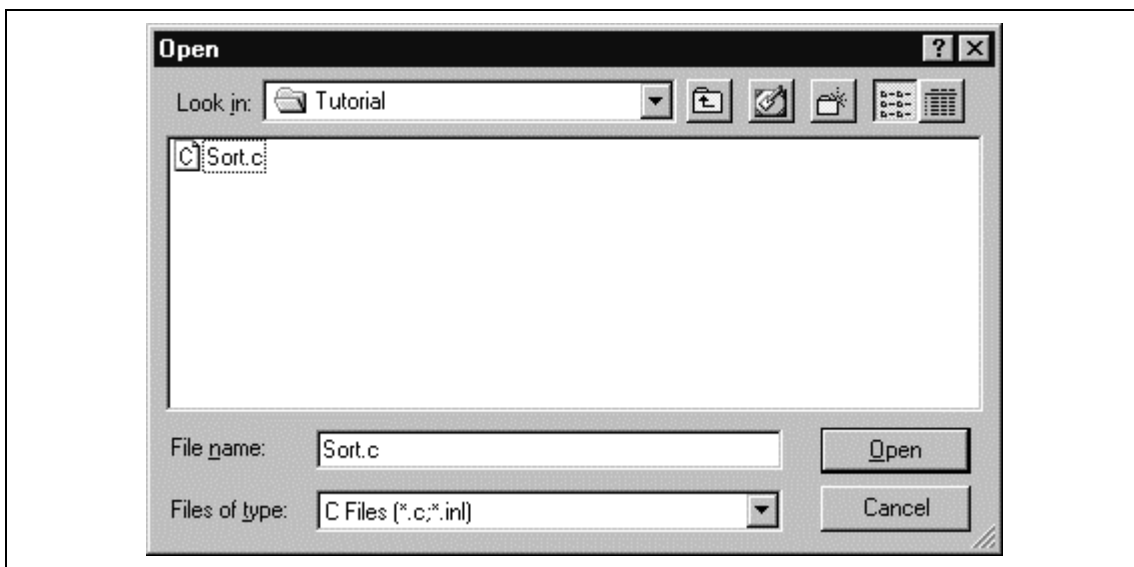

**Figure 3.8 [Open] Dialog Box**

- Select [Sort.c] and click the [Open] button. The [Program] window is displayed.

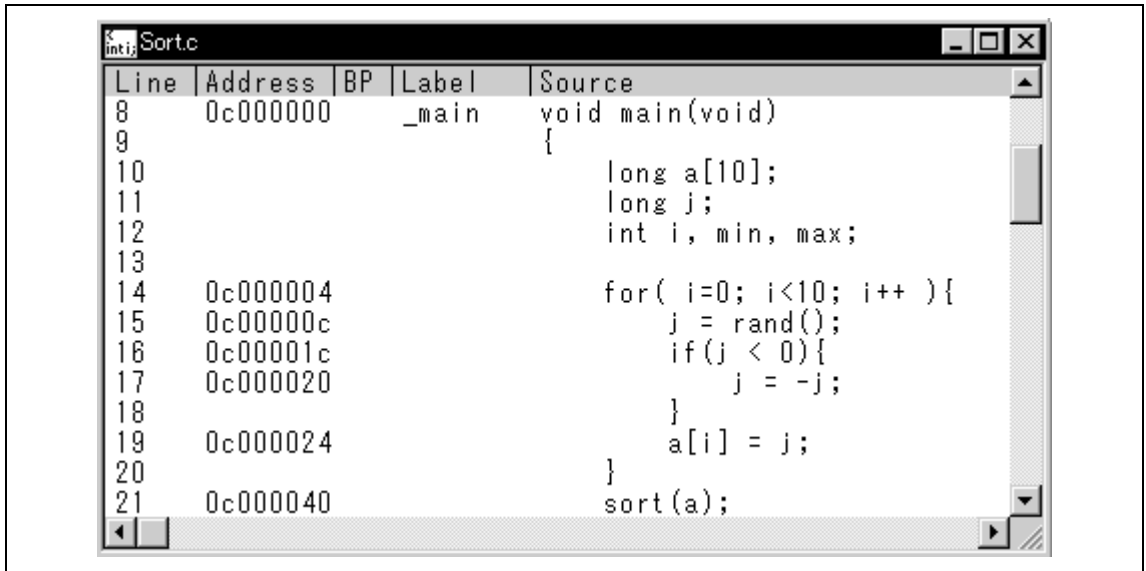

**Figure 3.9 [Program] Window (Displaying the Source Program)**

- If necessary, select the [Font] option from the [Customize] submenu on the [Setup] menu to select a clear font and size.

Initially the [Program] window shows the start of the main program, but the user can use the scroll bar to scroll through the program to see the other statements.

### 3.7 Setting the Software Breakpoint

A breakpoint is one of the easy debugging functions.

The [Program] window provides a very simple way of setting a software breakpoint in a program. For example, to set a breakpoint at the `sort` function call:

- Select by double-clicking the [BP] column on the line containing the `sort` function call.

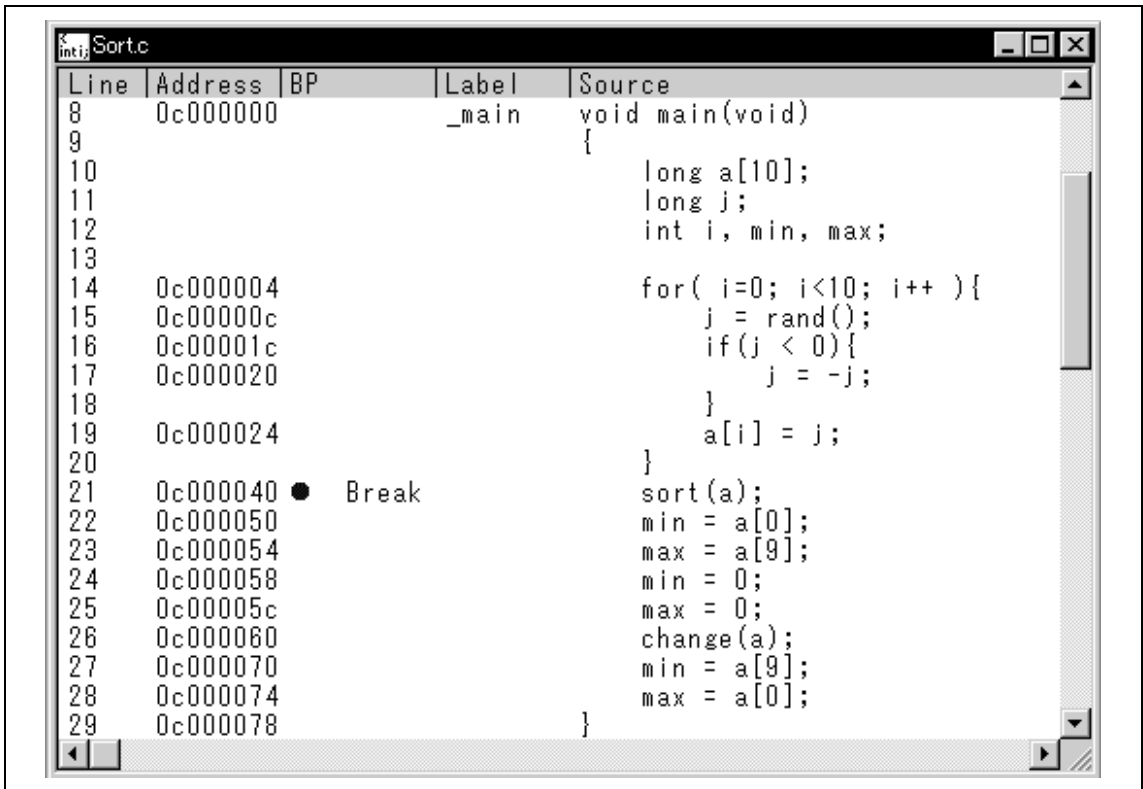

Figure 3.10 [Program] Window (Setting a Software Breakpoint)

The ● Break will be displayed on the line containing the `sort` function to show that a software breakpoint is set.

Note: The software breakpoint cannot be set in the ROM area or the delay slots in the program.

### 3.8 Setting Registers

Set values of the program counter and the stack pointer before executing the program.

- Select [Registers] from the [View] menu. The [Registers] window is displayed.

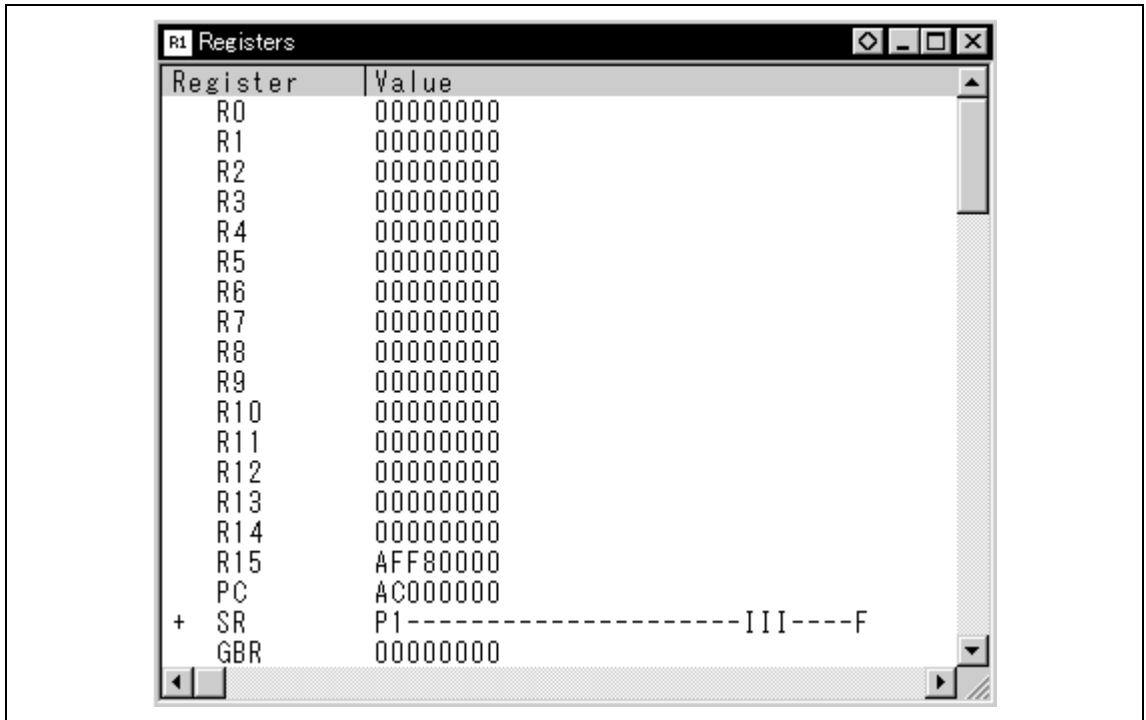
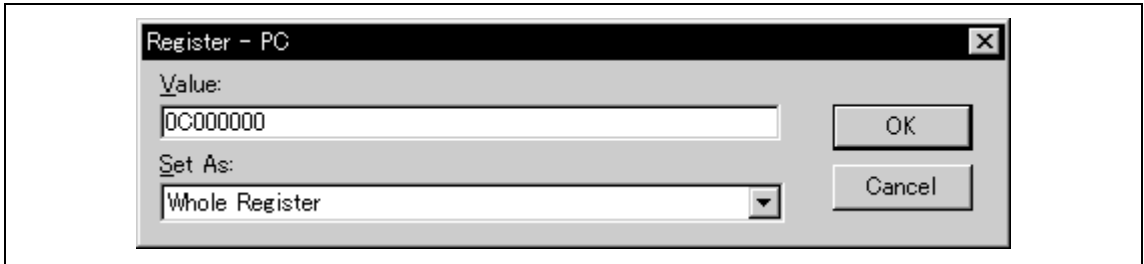

Figure 3.11 [Registers] Window

- To change the value of the program counter, double-click the value area in the [Registers] window with the mouse. The following dialog box is then displayed, and the value can be changed.



**Figure 3.12 [Register] Dialog Box (PC)**

- Enter H'0C000000 in the [Value] edit box, and click the [OK] button.
- To change the value of the stack pointer, move the mouse pointer to the value area of [R15] in the [Registers] window and enter a new value directly, or double-click the value area with the mouse to open the following dialog box.

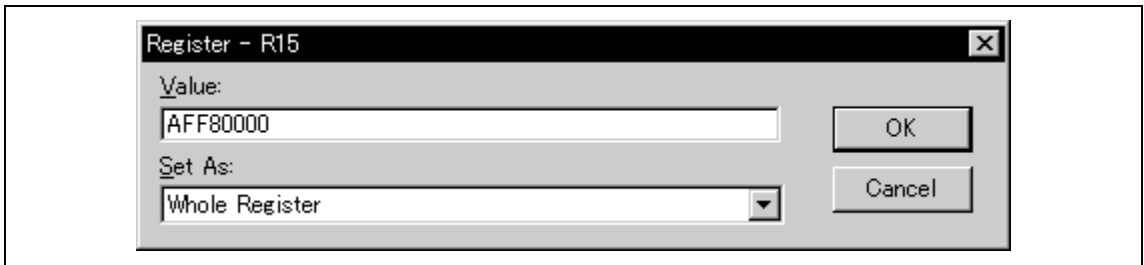

**Figure 3.13 [Register] Dialog Box (SP)**

- Enter H'AFF80000 in the [Value] edit box, and click the [OK] button.

### 3.9 Executing the Program

Execute the program as described in the following:

- To execute the program, select [Go] from the [Run] menu, or click the [Go] button on the toolbar.



Figure 3.14 [Go] Button

The program will be executed up to the breakpoint that has been set, and a statement will be highlighted in the [Program] window to show the position that the program has halted. [Break = Breakpoint] will appear on the status bar.

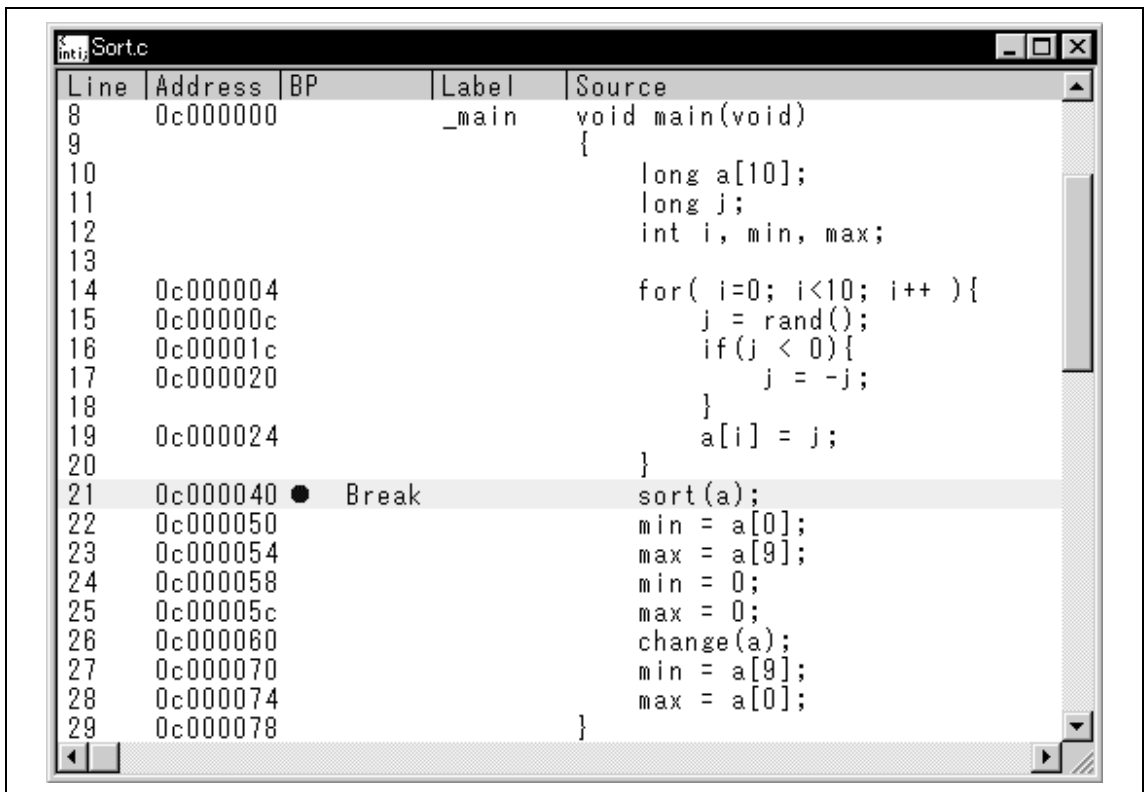
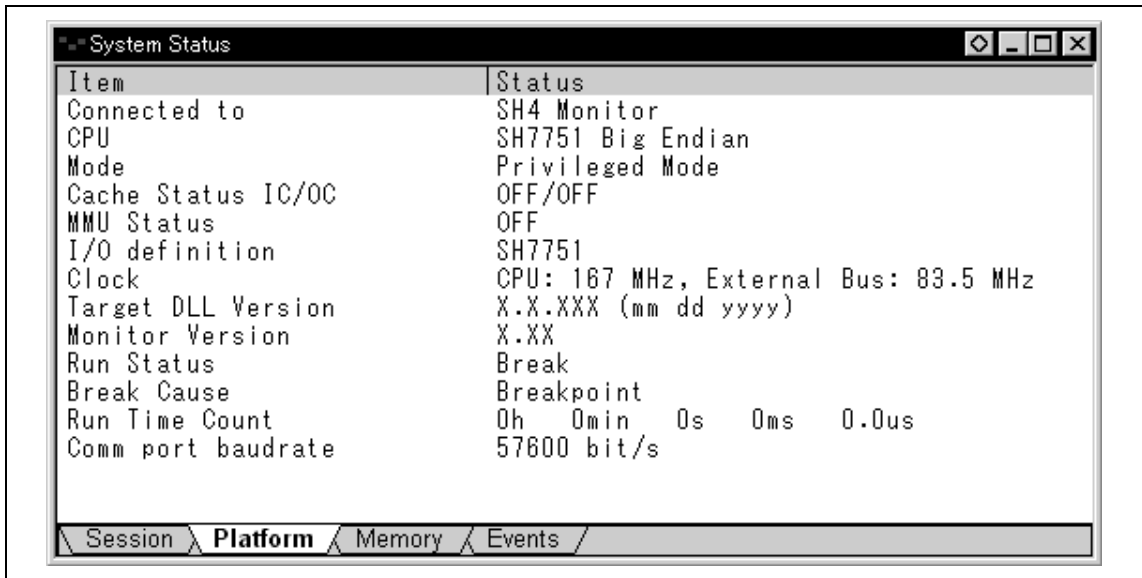

Figure 3.15 [Program] Window (Break Status)

The user can see the cause of the break that occurred last time in the [System Status] window.

- Select [Status] from the [View] menu.

The [System Status] window will appear. Open the [Platform] sheet and check the status of Break Cause.



**Figure 3.16 [System Status] Window**

The [System Status] window displays the following items in each page.

**Table 3.4 Contents of the [System Status] Window**

Sheet	Item	Description
[Session]	Target System	Indicates whether the CPU board is connected or not.
	Session Name	Displays the session file name.
	Program Name	Displays the load module file name.
[Platform]	Connected to	Displays the name of the connected CPU board monitor program.
	CPU	Displays the target CPU and endian setting.
	Mode	Displays the CPU processor mode (privileged mode or user mode).
	Cache Status IC/OC	Shows whether the cache is enabled or disabled.
	MMU Status	Shows whether the MMU is enabled or disabled.
	I/O definition	Displays the selected I/O register definition file.
	Clock	Displays the clock frequency (CPU operating frequency and external bus frequency) being used.
	Target DLL Version	Indicates the version of the target DLL for connection to the CPU board.
	Monitor Version	Displays the monitor program version.
	Run Status	Displays the user program execution status: Run: Being executed Break: Stopped
	Break Cause	Displays the cause of the program stopping at break.
	Run Time Count	Shows the time from the start of the user program to the break. When the run time count function is disabled, "0h 0min 0s 0ms 0.0us" is displayed.
	Comm port baudrate	Indicates the data baud rate for the serial interface.
[Memory]	Target Device Configuration	Not supported by this CPU board.
	System Memory Resources	Not supported by this CPU board.
	Loaded Memory Areas	Shows the area where the load module is loaded.
[Events]	Resources	Shows the number of breakpoints set.

### 3.10 Reviewing Breakpoints

The user can see all the breakpoints set in the program in the [Breakpoints] window.

- Select [Breakpoints] from the [View] menu.

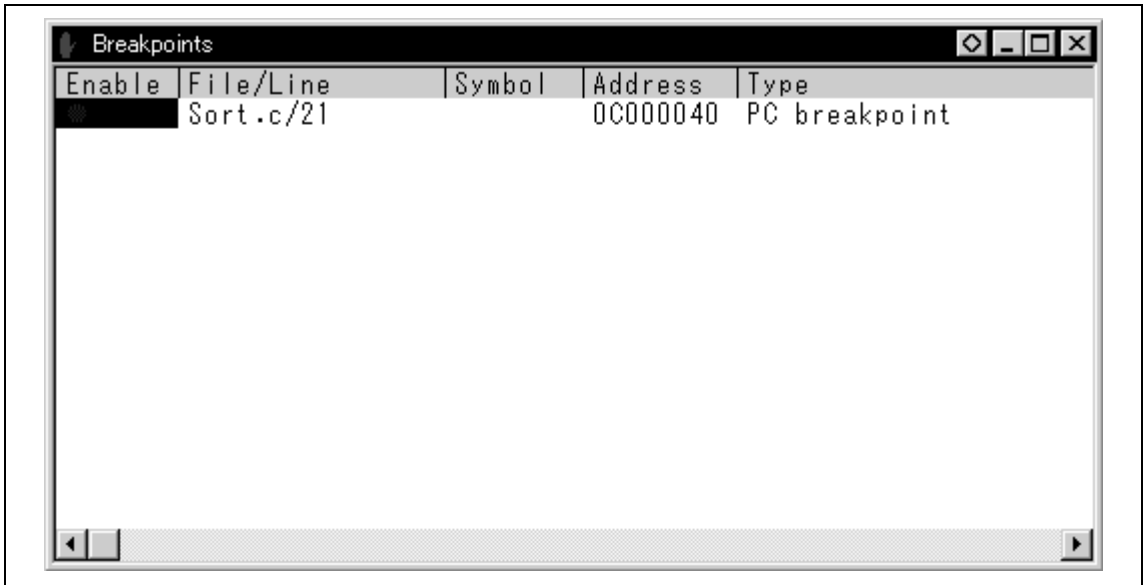

**Figure 3.17 [Breakpoints] Window**

Right-clicking in the [Breakpoints] window will open a pop-up menu, through which breakpoints can be set, changed, deleted, enabled, or disabled.

### 3.11 Viewing Memory

The user can view the contents of a memory block in the [Memory] window. For example, to view the memory contents corresponding to the main in word size:

- Select [Memory ...] from the [View] menu, enter main in the [Address] edit box, and set Word in the [Format] combo box.

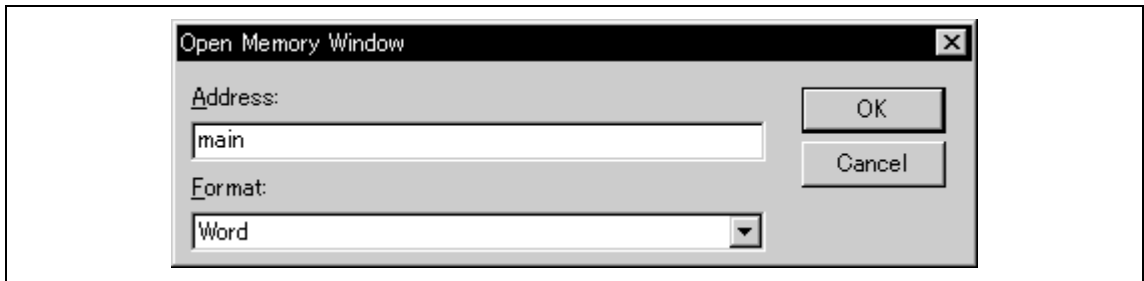

Figure 3.18 [Open Memory Window] Dialog Box

- Click the [OK] button. The [Memory] window showing the specified area of memory is displayed.

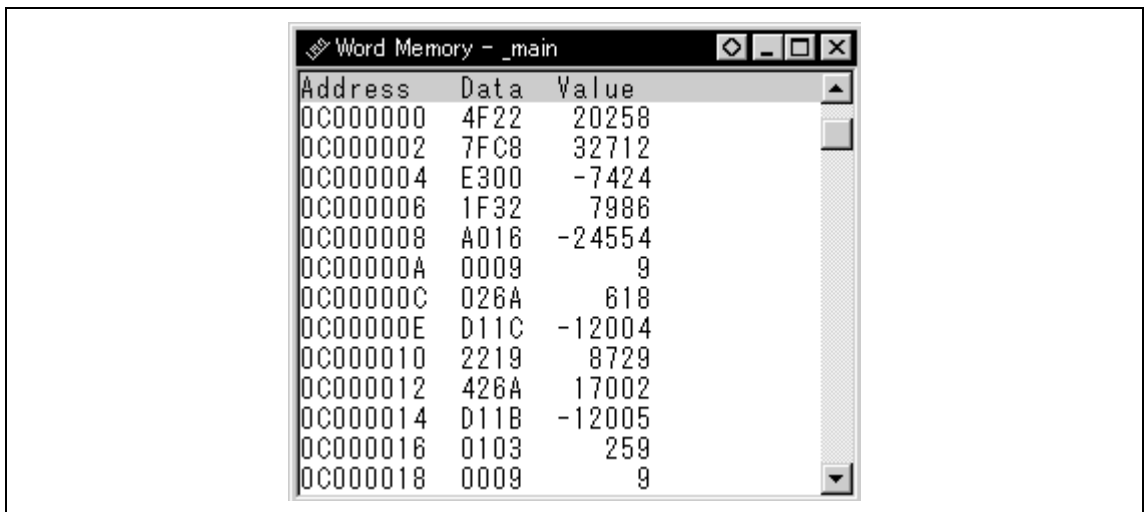

Figure 3.19 [Word Memory] Window

### 3.12 Watching Variables

As the user steps through a program, it is possible to watch that the values of variables used in the user program are changed. For example, set a watch on the long-type array `a` declared at the beginning of the program, by using the following procedure:

- Click the left of displayed array `a` in the [Program] window to position the cursor.
- Click the [Program] window with the right mouse button and select [Instant Watch...] from a pop-up menu.

The following dialog box will be displayed.

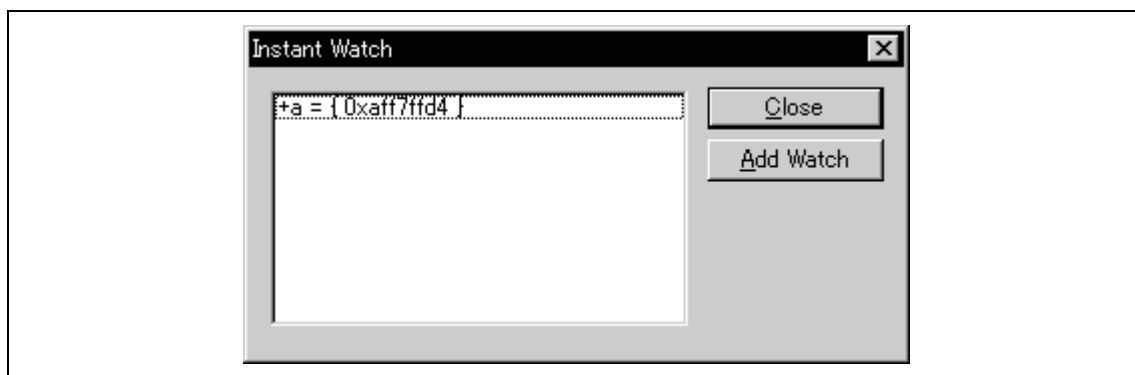

Figure 3.20 [Instant Watch] Dialog Box

- Click [Add Watch] button to add a variable to the [Watch Window] window.



**Figure 3.21 [Watch Window] Window (Displaying the Array)**

The user can also add a variable to the [Watch Window] window by specifying its name.

- Click the [Watch Window] window with the right mouse button and select [Add Watch...] from the pop-up menu.

The following dialog box will be displayed.



**Figure 3.22 [Add Watch] Dialog Box**

- Input variable `max` and click the [OK] button.

The [Watch Window] window will now also show the long-type variable `max`.



**Figure 3.23 [Watch Window] Window (Displaying the Variable)**

The user can double-click the + symbol to the left of array `a` to watch the all elements in array `a`.

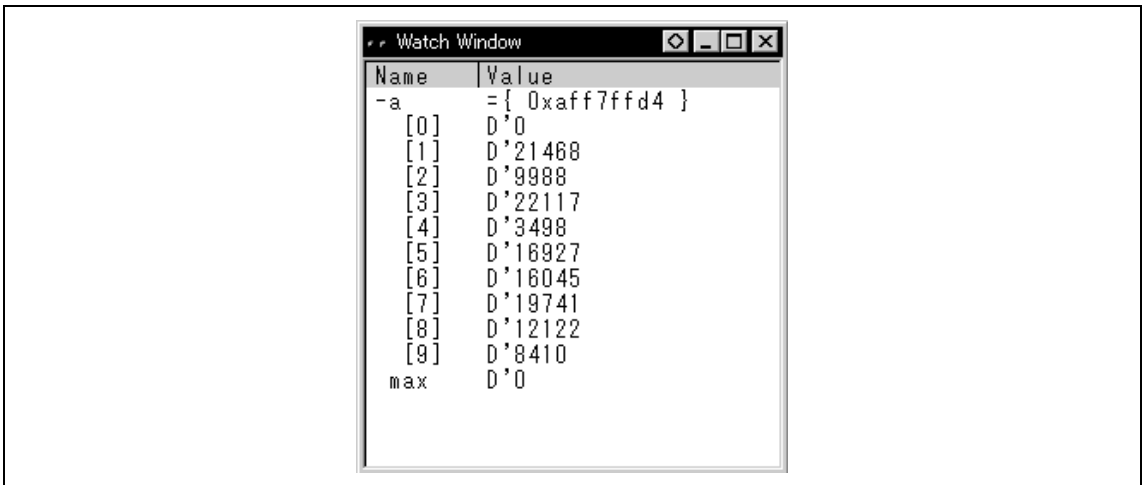

**Figure 3.24 [Watch Window] Window (Displaying Array Elements)**

### 3.13 Stepping Through a Program

The HDI provides a range of step menu commands that allow efficient program debugging.

**Table 3.5 Step Option**

Menu Command	Description
Step In	Executes each statement, including statements within functions.
Step Over	Executes a function call in a single step.
Step Out	Steps out of a function, and stops at the statement following the statement in the program that called the function.
Step...	Steps the specified times repeatedly at a specified rate.

Use the [Go] described in section 3.9, Executing the Program, to confirm that the program is executed up to the `sort` function statement at address H'0C000040.

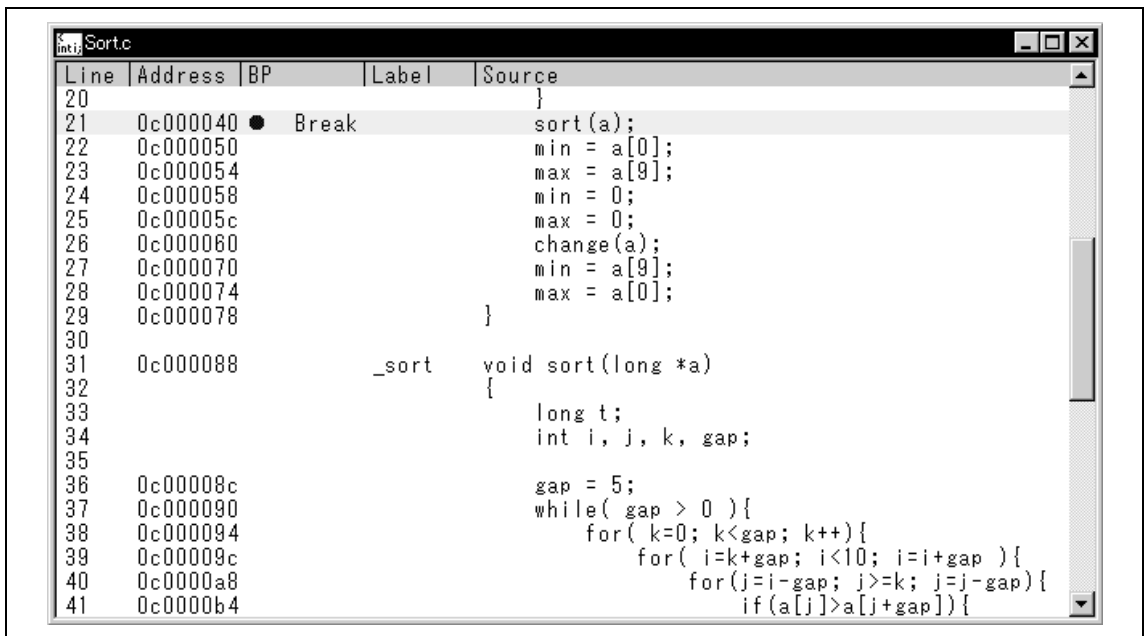

**Figure 3.25 [Program] Window (Step Execution)**

### 3.13.1 Executing [Step In] Command

The [Step In] steps into the called function and stops at the first statement of the called function.

- To step through the `sort` function, select [Step In] from the [Run] menu, or click the [Step In] button in the toolbar.



Figure 3.26 [Step In] Button

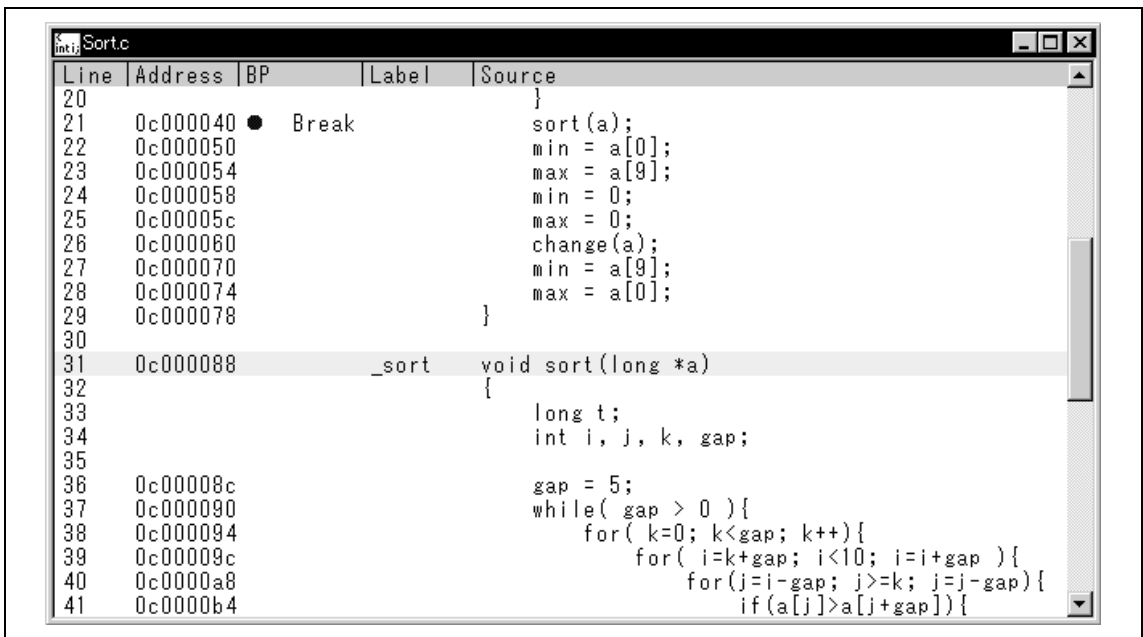

Figure 3.27 [Program] Window (Step In)

- The highlighted line moves to the first statement of the `sort` function in the [Program] window.

### 3.13.2 Executing [Step Out] Command

The [Step Out] steps out of the called function and stops at the next statement of the calling statement in the main function.

- To step out of the `sort` function, select [Step Out] from the [Run] menu, or click the [Step Out] button in the toolbar.



Figure 3.28 [Step Out] Button

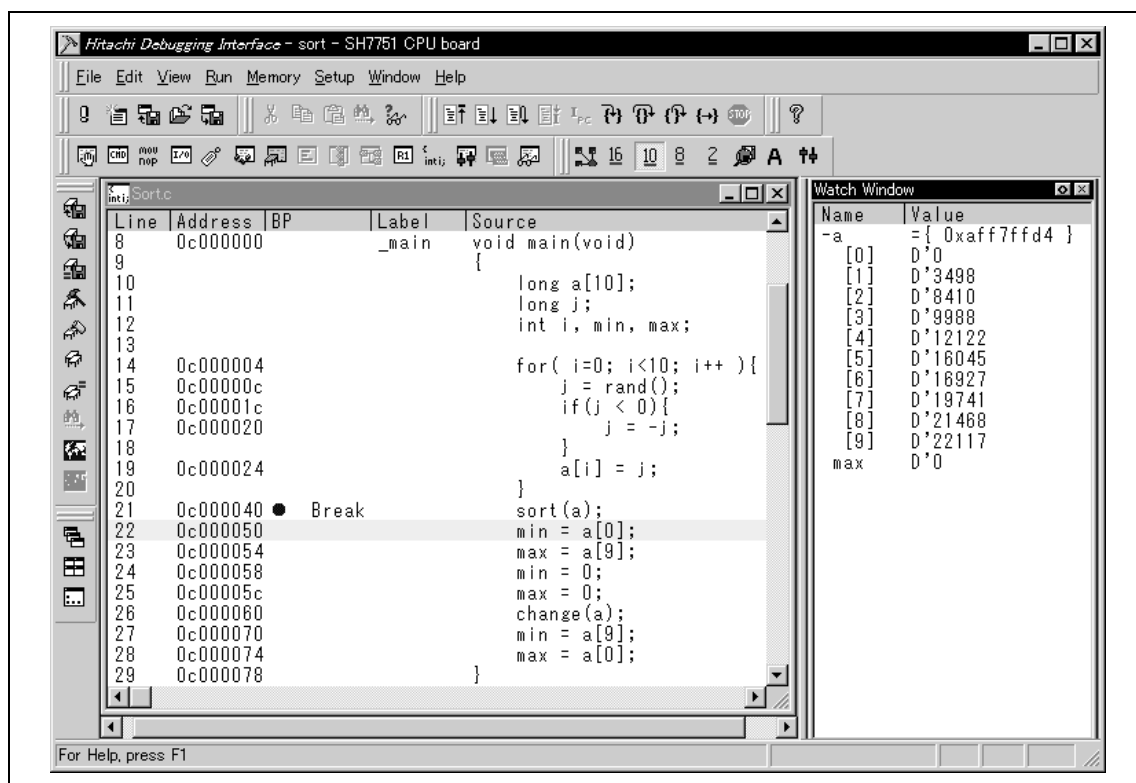

Figure 3.29 [Program] Window (Step Out)

- The values of array `a` is sorted in ascending order.
- To execute two steps, use [Step In] twice.

- The value of max displayed in the [Watch Window] window is changed to the maximum data value.

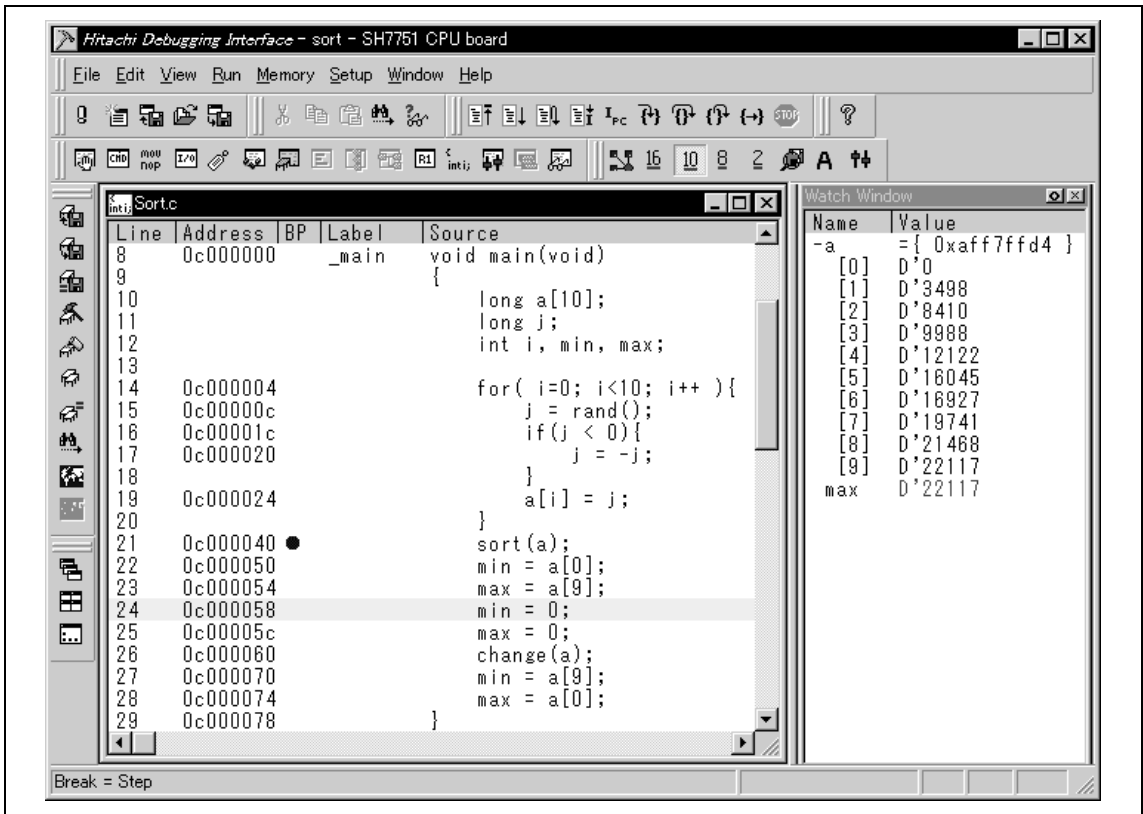

Figure 3.30 [Program] Window (Step In → Step In)

### 3.13.3 Executing [Step Over] Command

The [Step Over] executes a function call as a single step and stops at the next statement of the main program.

- Using [Step In], execute two steps to reach the change function statement.
- To step through all statements in the change function at a single step, select [Step Over] from the [Run] menu, or click the [Step Over] button in the toolbar.



Figure 3.31 [Step Over] Button

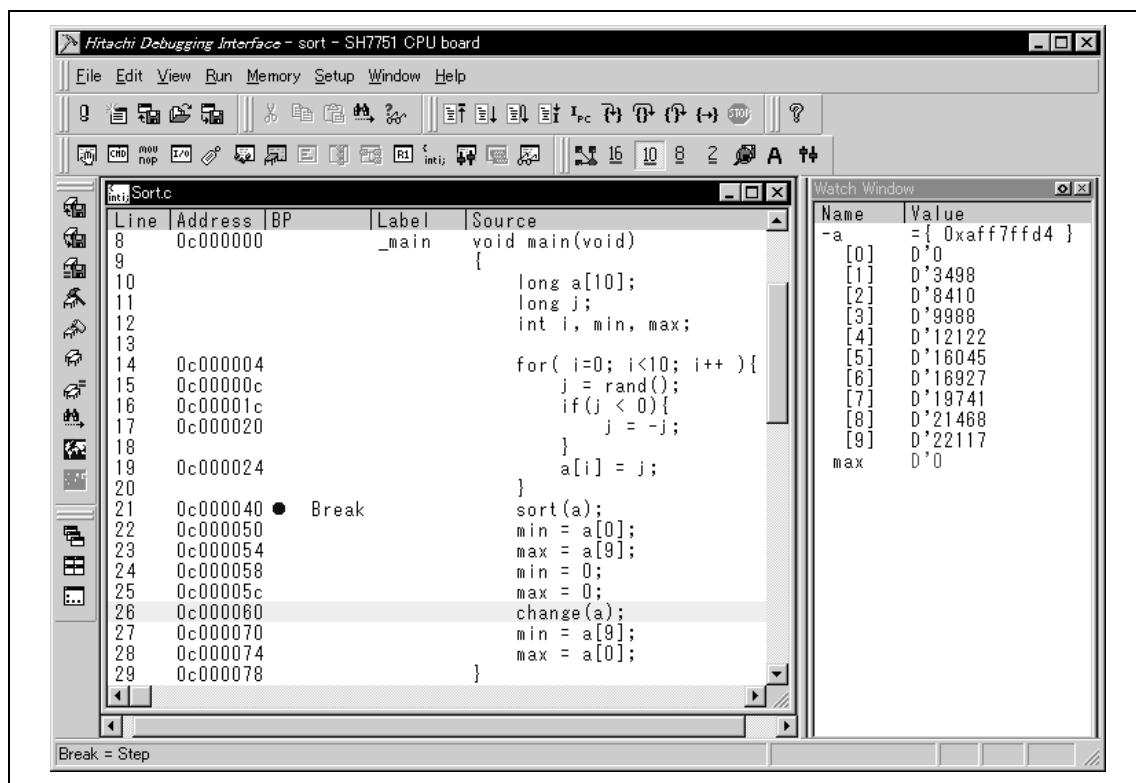
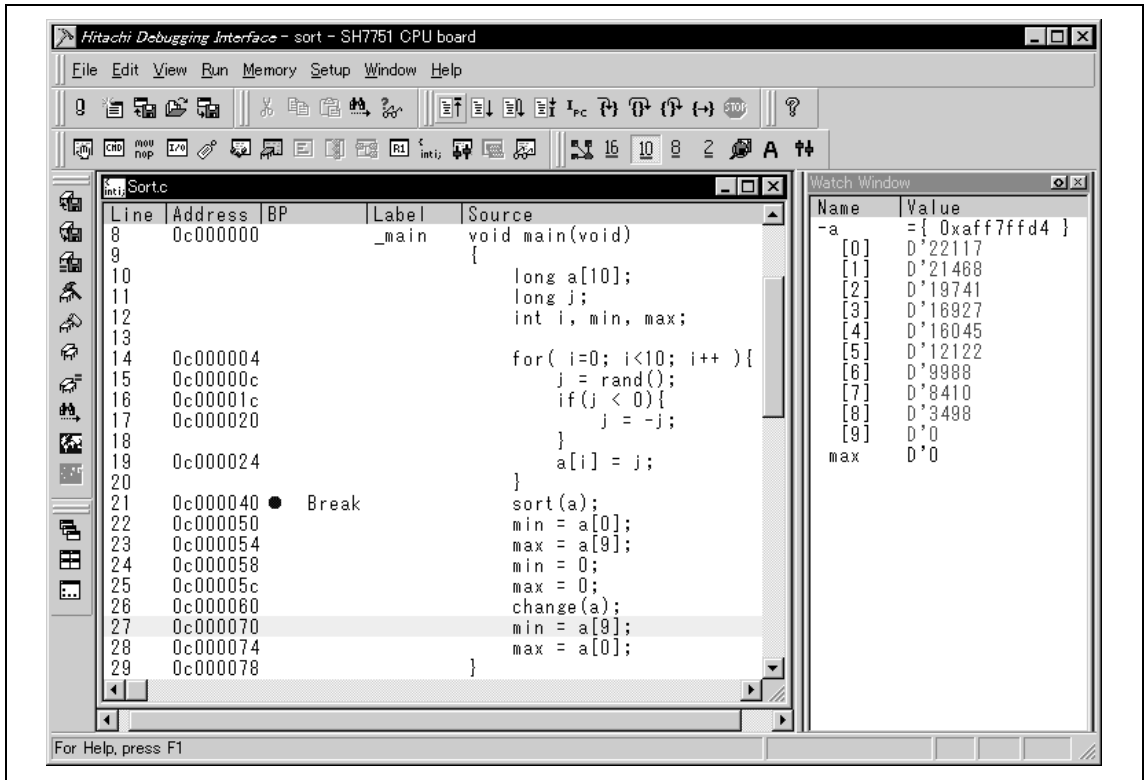

Figure 3.32 [Program] Window (Before Step Over Execution)



**Figure 3.33 [Program] Window (Step Over)**

When the last statement of the change function is executed, the data of array a, which is displayed in the [Watch Window] window, is sorted in descending order.

### 3.14 Displaying Local Variables

The user can display local variables in a function using the [Locals] window. For example, we will examine the local variables in the `main` function, which declares five local variables: `a`, `j`, `i`, `min`, and `max`.

- Select [Locals] from the [View] menu. The [Locals] window is displayed.

If no local variable exists, none is displayed on the [Locals] window.

- Select [Step In] from the [Run] menu to execute another step.

The local variables and the corresponding values are displayed in the [Locals] window.

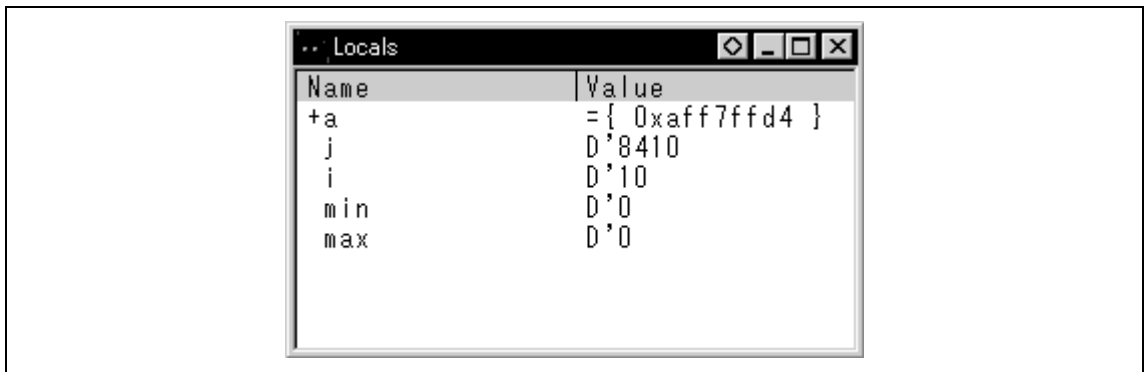

Figure 3.34 [Locals] Window

- Double-click the + symbol in front of array `a` in the [Locals] window to display the elements of array `a`.
- When the elements of the array `a` are referenced before and after executing the `sort` function in the program, the random data should be sorted in descending order. This confirms that the program is operating normally.

### 3.15 Software Break Function

The CPU board has software break function. With the HDI, a software breakpoint can be set using the [Breakpoints] window. The CPU board can set up to 255 software breakpoints.

Setting a software breakpoint is described below.

- Select [Breakpoints] from the [View] menu. The [Breakpoints] window is displayed.
- Right-click in the [Breakpoints] window to open a pop-up menu, and select the [Del All] button to cancel all the breakpoints that have been set. A dialog box will prompt you to confirm the deletion of breakpoints. Click [Yes] to delete the breakpoints.

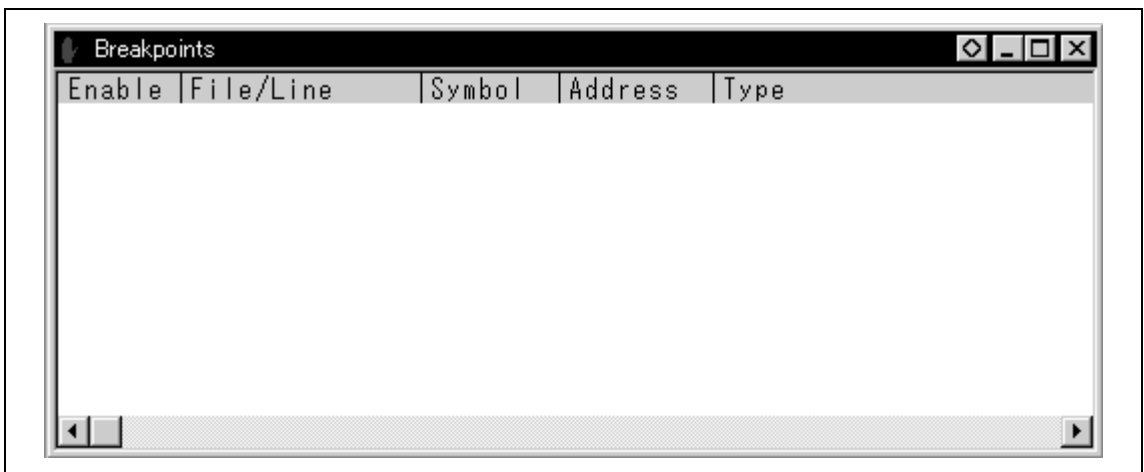
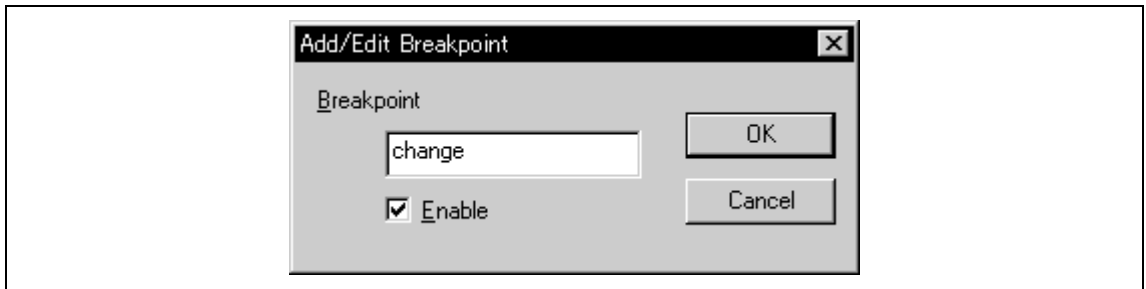

Figure 3.35 [Breakpoints] Window (Before setting software break)

Right-click in the [Breakpoints] window to open a pop-up menu, and select [Add].

The [Add/Edit Breakpoint] dialog box is displayed. Either an address or a symbol can be entered.

- Enter change and check the [Enable] checkbox.



**Figure 3.36 [Add/Edit Breakpoint] Dialog Box**

- Click the [OK] button.

The software breakpoint that has been set is displayed in the [Breakpoints] window.

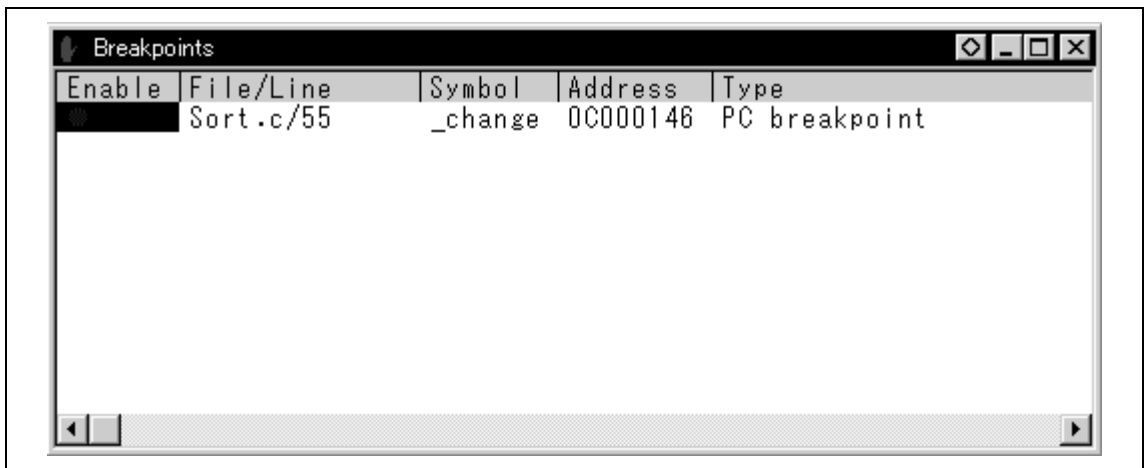
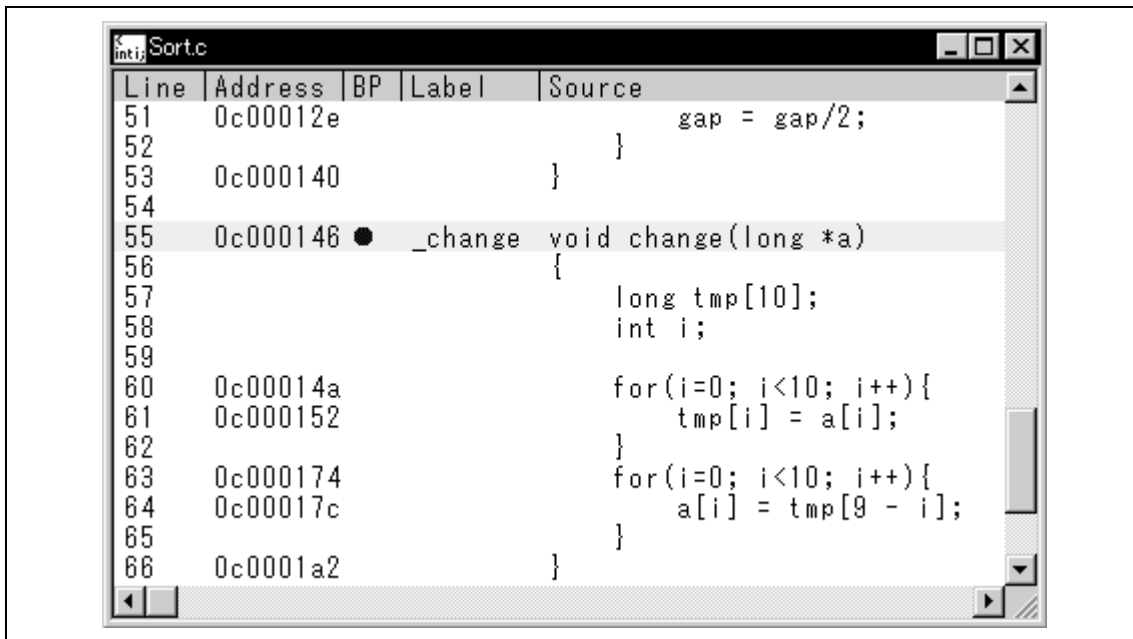

**Figure 3.37 [Breakpoints] Window (Software Breakpoint Setting)**

To stop the tutorial program at the breakpoint, the following procedure must be executed:

- Close the [Breakpoints] window.
- Set the program counter and stack pointer values that have been set in section 3.8, Setting Registers, (PC = H'0C000000, R15 = H'AFF80000) in the [Registers] window. Click the [Go] button.

The program runs, and stops at the set breakpoint.



**Figure 3.38 [Program] Window at Execution Stop (Software Break)**

Select [Status] from the [View] menu. The [System Status] window displays the following contents. The window confirms that execution was stopped at a breakpoint.

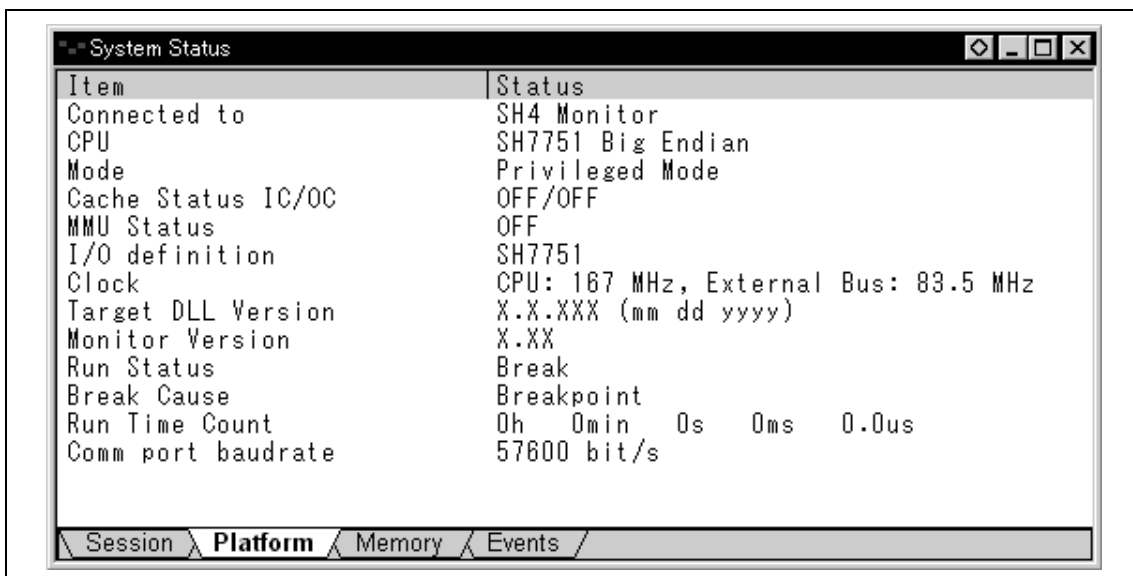

**Figure 3.39 Displayed Contents of the [System Status] Window (Software Break)**

### 3.16 Run Time Count Function

By enabling the run time count function and executing the user program, the user program run time can be measured. In the following example, the run time of the `sort` function is measured.

- Select [Delete All] from the pop-up menu in the [Breakpoints] window, and double-click the [BP] column on the 21st and 22nd lines in the [Program] window to set breakpoints.
- Set the program counter and stack pointer values that have been set in section 3.8, Setting Registers, (PC = H'0C000000, R15 = H'AFF80000) in the [Registers] window. Click the [Go] button.

The program runs and stops at the breakpoint.

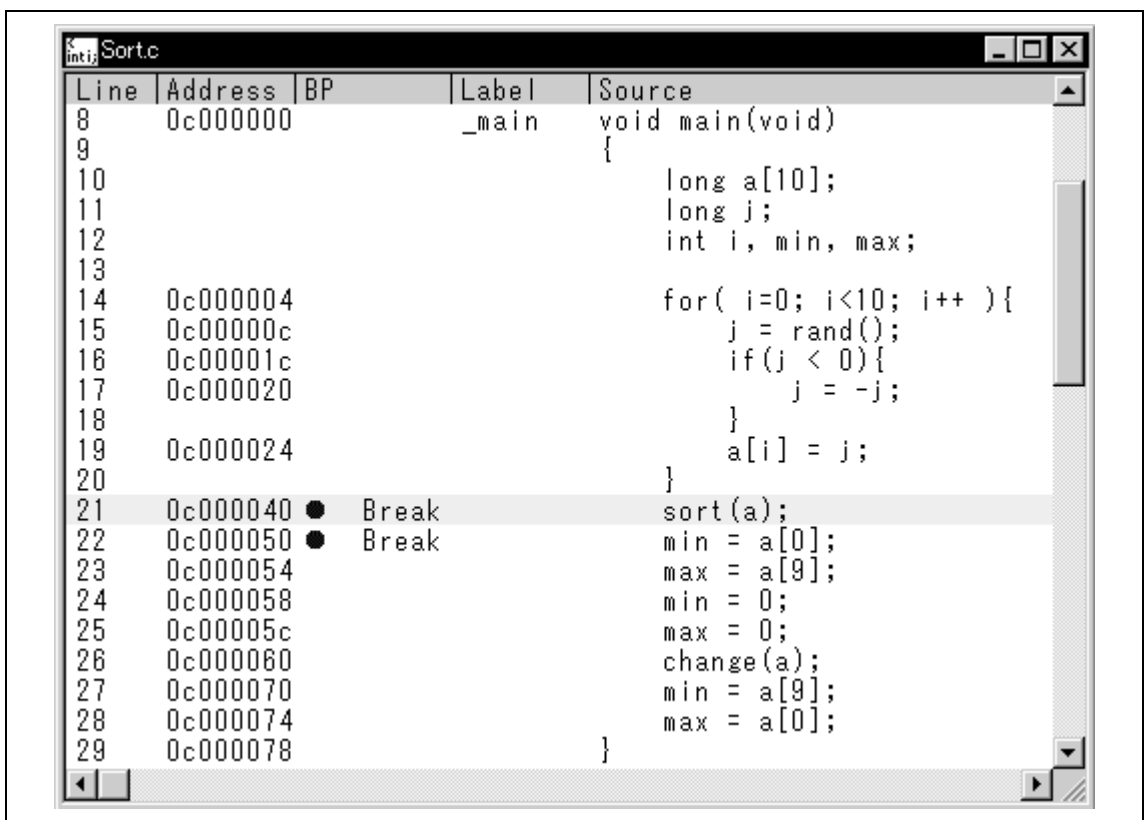
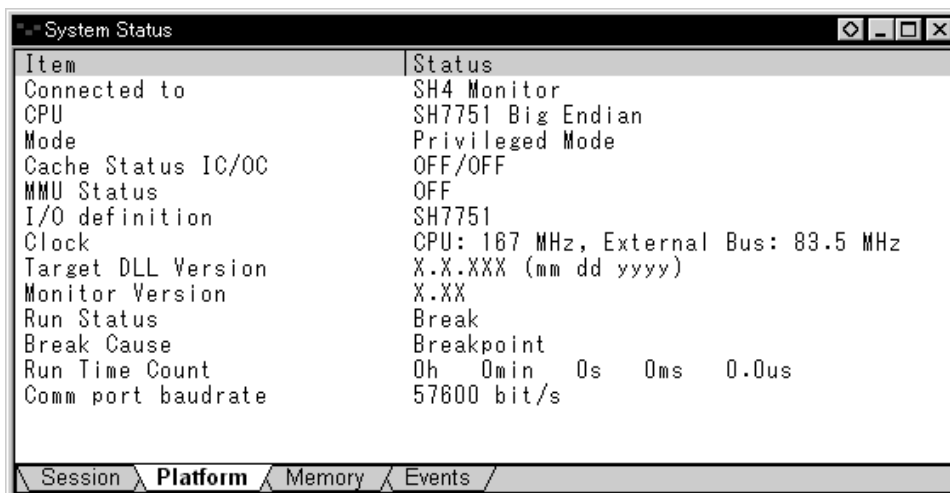

Figure 3.40 [Program] Window (Break before Run Time Count)

- Select [Status] from the [View] menu. The [System Status] window will appear.



**Figure 3.41 [System Status] Window (Run Time Count Disabled)**

The time taken from the start of the program to the break is shown as the Run Time Count on the [Platform] sheet in the [System Status] window. In this example, the run time count function has not been enabled, "0h 0min 0s 0ms 0.0us" is displayed.

- Select [Run Time...] from the [View] menu. The [Run Time Count Condition] dialog box will appear.
- Check the [Enable] check button, select a measurement unit from [Measurement Mode], and click the [OK] button. In this example, 0.10us (Max 6min50s) is selected.

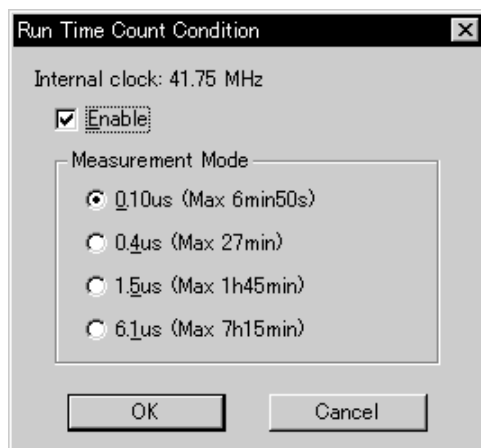

**Figure 3.42 [Run Time Count Condition] Dialog Box**

The items listed in table 3.6 can be set in the [Run Time Count Condition] dialog box. The run time can be checked in the [System Status] window.

**Table 3.6 Items Set in [Run Time Count Condition] Dialog Box**

Item	Description
Enable	Check this box to enable the run time count function. The default setting is "disable".
Measurement Mode	Select a measurement unit here.

The selectable measurement units depend on the jumper setting (J23: bus frequency setting) on the CPU board as shown in table 3.7.

**Table 3.7 Selectable Measurement Units**

J23 Setting	Internal Peripheral Module Operating Clock	Measurement Unit	Maximum Measurable Time
Closed	27.83 MHz	0.15 $\mu$ s	Approximately 10 minutes
		0.6 $\mu$ s	Approximately 41 minutes
		2.3 $\mu$ s	Approximately 2 hours 45 minutes
		9.2 $\mu$ s	Approximately 11 hours
Open	41.75 MHz	0.10 $\mu$ s	Approximately 6 minutes 50 seconds
		0.4 $\mu$ s	Approximately 27 minutes
		1.5 $\mu$ s	Approximately 1 hour 45 minutes
		6.1 $\mu$ s	Approximately 7 hours 15 minutes

- Click the [OK] button to enable the run time count function.

- Click the [Go] button. Execution will stop at the line following the `sort` function, and the run time will be displayed in a message box.

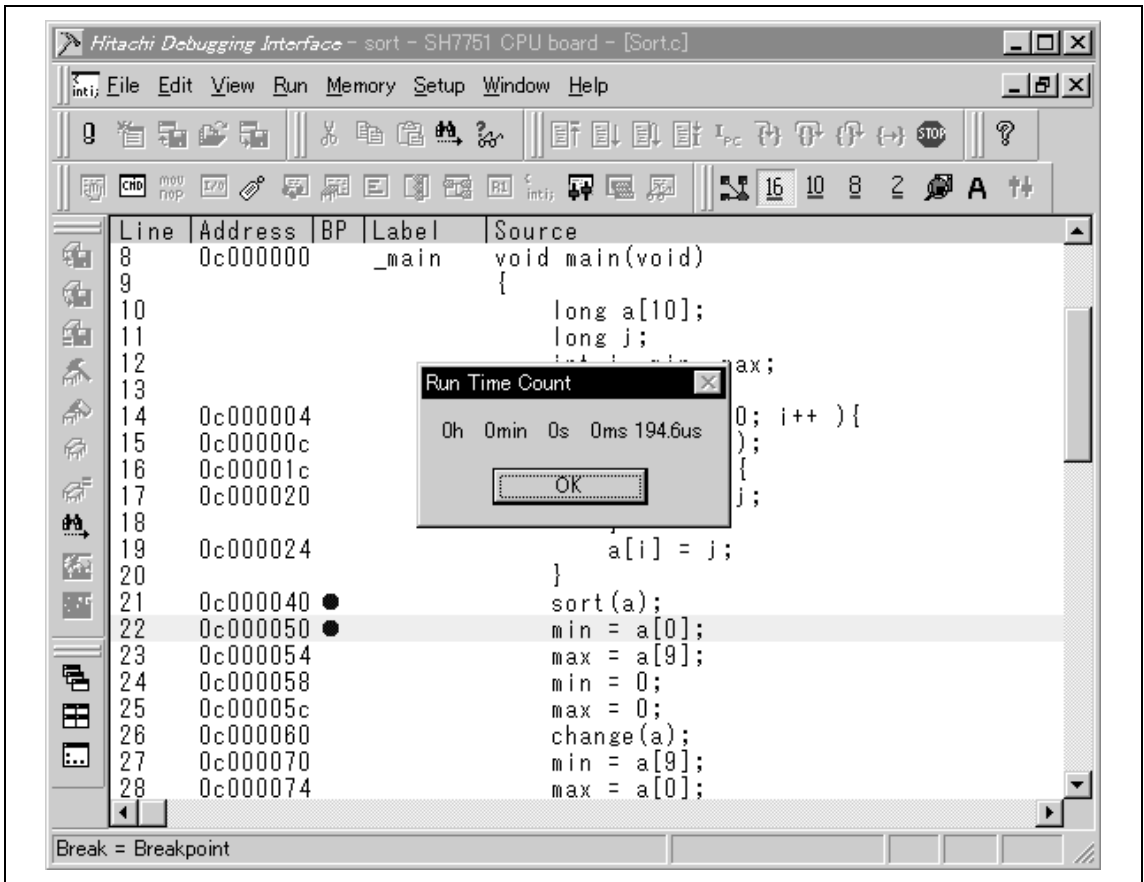

**Figure 3.43 [Program] Window (Stopped at a Breakpoint after Run Time Count)**

The time from the `sort` function call to the return to the caller can be checked at Run Time Count on the [Platform] sheet in the [System Status] window.

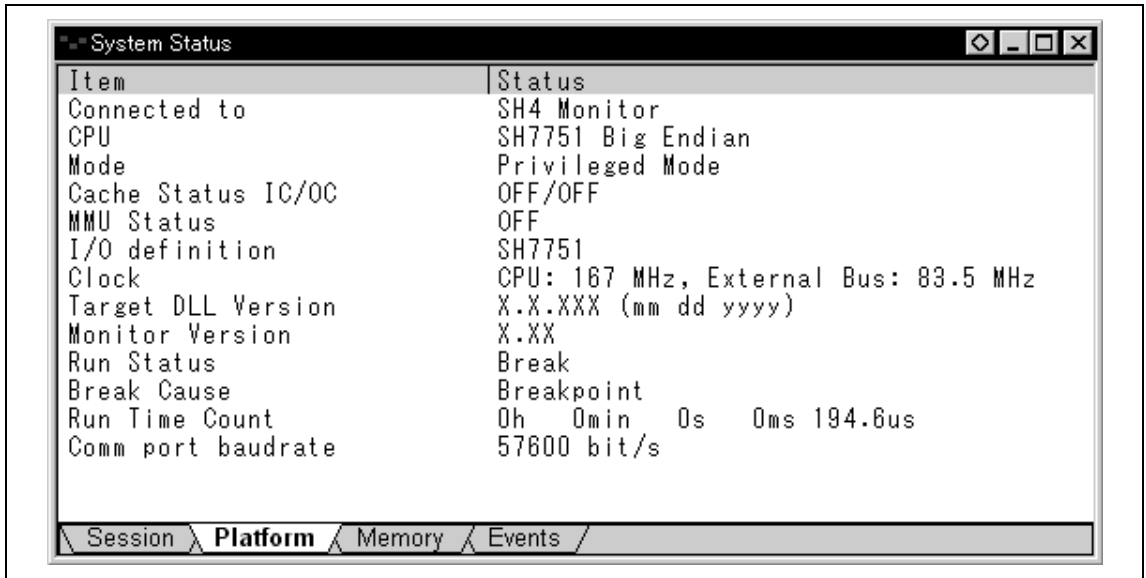

**Figure 3.44 [System Status] Window (Run Time Count Result)**

- Notes:
1. The run time will vary depending on the execution environment.
  2. The run time can be measured by executing with [Go] but cannot be measured by [Step In], [Step Out], or [Step Over].

### 3.17 Saving a Session

If a program has been downloaded, the corresponding source file is displayed, and numerous windows are opened, it can take some time to restore this setup the next time the program is downloaded. The HDI is able to save the current settings for retrieval the next time the program is loaded, in order to reduce setup time.

In order to save a session which has already been named, or to save the session with the same name as the current object file, select [Save Session] from the [File] menu.

To save the current settings as a session with a new name, select the [Save Session As...] command from the [File] menu. A dialog box is displayed; enter the new name for the session. Three files are saved: the HDI session file (\*.hds), the target session file (\*.hdt), and the watch session file (\*.hdw).

The target session file stores the following information:

- Software breakpoint information
- I/O definition file information
- Run time count function information

Note: No symbol or memory information is saved in the session files. If changes are to be used again in future, they must be saved separately. For details, refer to the Hitachi Debugging Interface User's Manual.

### **3.18 What Next?**

In this tutorial, we have introduced as examples program debugging using the CPU board and the HDI.

Further details on the use of the HDI can be found in the Hitachi Debugging Interface User's Manual available in the supplied CD-R.



## Section 4 Descriptions of Windows

### 4.1 HDI Windows

HDI window menu bars and the corresponding pull-down menus are listed in table 4.1.

A **O** mark and/or the relevant section number is shown in the table when menu description is included in the Hitachi Debugging Interface User's Manual or in this manual.

Menu items shown in gray on the screen are not available.

**Table 4.1 HDI Window Menus and Related Manual Entries**

<b>Menu Bar</b>	<b>Pull-Down Menu</b>	<b>Hitachi Debugging Interface User's Manual</b>	<b>This Manual</b>
File Menu	New Session...	O	—
	Load Session...	O	—
	Save Session	O	—
	Save Session As...	O	3.17
	Load Program...	O	3.6.1
	Initialize	O	—
	Exit	O	—
	Edit Menu	Cut	O
Copy		O	—
Paste		O	—
Find...		O	—
Evaluate...		O	—

**Table 4.1 HDI Window Menus and Related Manual Entries (cont)**

Menu Bar	Pull-Down Menu	Hitachi Debugging Interface	
		User's Manual	This Manual
View Menu	Breakpoints	O	3.10, 3.15, 4.2.2
	Command Line <sup>*4</sup>	O	—
	Disassembly...	O	—
	I/O Area	O	—
	Labels	O	—
	Locals	O	3.14
	Memory...	O	3.11
	Performance Analysis <sup>*1</sup>	O	—
	Profile-List <sup>*1</sup>	O	—
	Profile-Tree <sup>*1</sup>	O	—
	Registers	O	3.8
	Source...	O	3.6.2
	Status	O	3.9, 4.2.4
	Trace <sup>*1</sup>	O	—
	Watch	O	—
	Cache Control...	—	4.2.6
	Run Time...	—	3.16, 4.2.5
	Localized Dump	O	—
	Simulated I/O Window	O	4.2.7
Run Menu	Reset CPU <sup>*5</sup>	O	—
	Go	O	3.9
	Reset Go <sup>*3</sup>	O	—
	Go to Cursor	O	—
	Set PC To Cursor	O	—
	Run...	O	—
	Step In	O	3.13.1
	Step Over	O	3.13.3
	Step Out	O	3.13.2
	Step...	O	—
	Halt	O	—

**Table 4.1 HDI Window Menus and Related Manual Entries (cont)**

Menu Bar	Pull-Down Menu	Hitachi Debugging Interface	
		User's Manual	This Manual
Memory Menu	Refresh	O	—
	Load...	O	—
	Save...	O	—
	Verify...	O	—
	Test...	O	—
	Fill...	O	—
	Copy...	O	—
	Compare...	O	—
	Configure Map... <sup>2</sup>	O	—
	Configure Overlay... <sup>1</sup>	O	—
Setup Menu	Status bar	O	—
	Options...	O	—
	Radix	O	—
	Customise	O	—
	Configure Platform...	O	3.5, 4.2.1
Window Menu	Cascade	O	—
	Tile	O	—
	Arrange Icons	O	—
	Close All	O	—
Help Menu	Index	O	—
	Using Help	O	—
	Search for Help on	O	—
	About HDI	O	—

Notes: 1. Function not supported.

2. Only CPU board ROM and RAM information display is supported.

3. User program is executed after setting PC to H'AC000000.

4. Function for test use. Correct operation cannot be guaranteed.

5. PC, SR, and VBR are initialized. The reset signal is not sent to the CPU.

## 4.2 Descriptions of Each Window

This section describes each window.

### 4.2.1 [Monitor Setup] Dialog Box

#### Function:

Specifies the setup conditions for the CPU board. This dialog can be displayed by selecting [Configure Platform...] from the [Setup] menu.

#### Window:

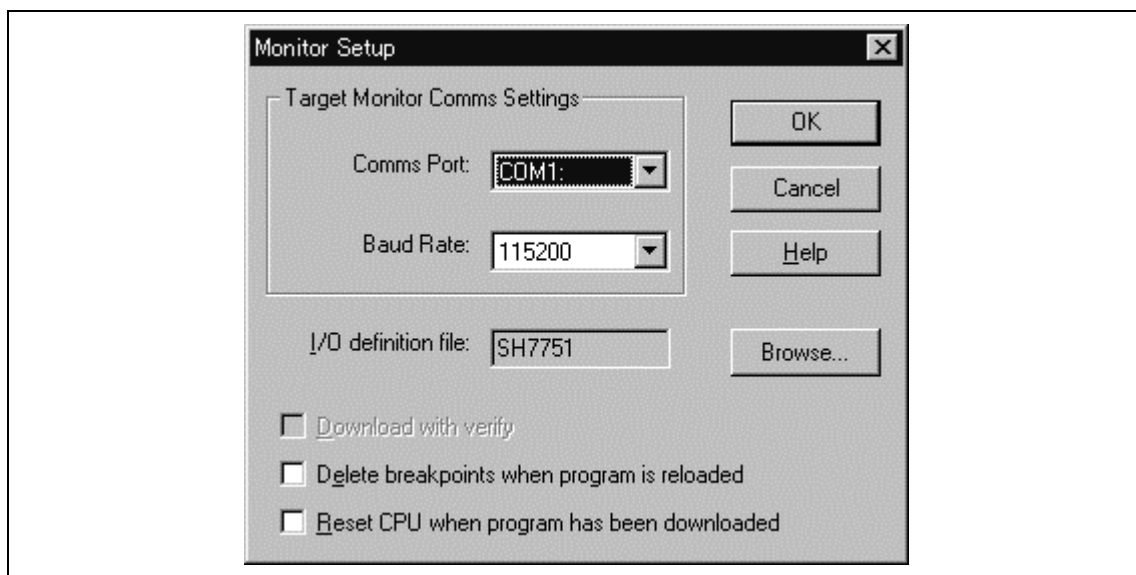

**Figure 4.1 [Monitor Setup] Dialog Box**

- Notes:
1. The I/O register definition file can be selected in this dialog box. Be sure to select a file within the HDI installation directory. Otherwise, the I/O register window will not operate correctly.
  2. The name of the I/O register definition file can consist of up to nine characters. This number does not include the file name's extension.

**Description:**

The settings of the [Monitor Setup] dialog box are indicated below.

**Table 4.2 [Monitor Setup] Dialog Box Page**

<b>Option</b>	<b>Setting</b>
Comms Port:	COM1, COM2, COM3, or COM4 can be selected as the host computer serial port.
Baud Rate:	Sets the serial baud rate. Select either 57600 bit/s or 115200 bit/s, to match the setting of jumper J36. Connection is not possible at any other setting.
I/O definition file	Sets the I/O register definition file. Click the [Browse] button to select the SH7751 definition file. When selecting a file, the [I/O Registers] window (accessed from the [View] menu) can be used to display register information.
Download with verify	The CPU board does not support this function (this box cannot be selected).
Delete breakpoints when program is reloaded	When this box is checked, all breakpoints are deleted when a program is reloaded.
Reset CPU when program has been downloaded	When this box is checked, registers are initialized* when a program is loaded. No reset signal is input to the CPU board.

Note: Initialized as follows: PC = H'AC000000, SR = H'600000E0, and VBR = H'A0080000 (big endian) or H'A0100000 (little endian).

Clicking the [OK] button sets the setup conditions. If the [Cancel] button is clicked, this dialog box is closed without setting the conditions.

## 4.2.2 [Breakpoints] Window

### Function:

This window lists all break conditions that have been set. This window can be displayed by selecting [Breakpoints] on the [View] menu.

### Window:

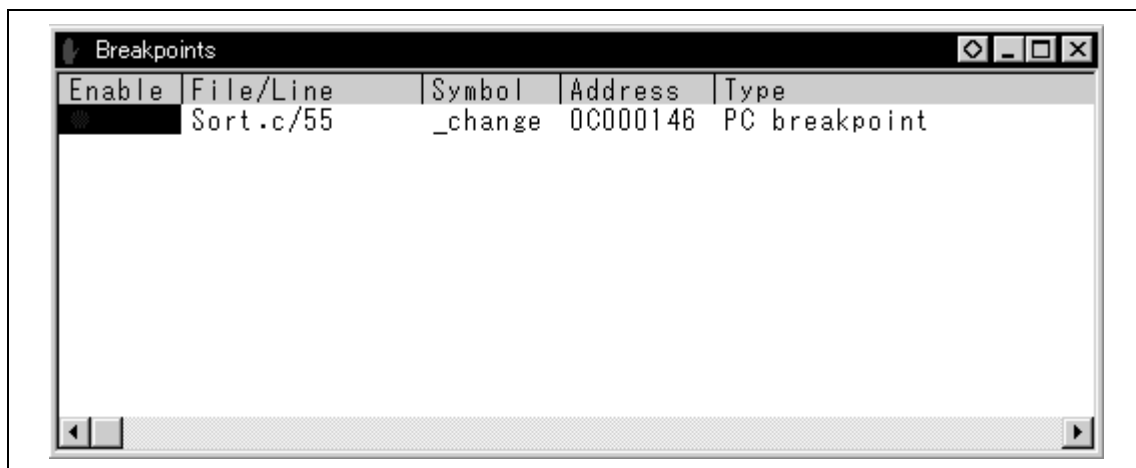

Figure 4.2 [Breakpoints] Window

**Description:**

The [Breakpoints] window displays breakpoint setting information. The items listed in table 4.3 are displayed.

**Table 4.3 [Breakpoints] Window Display Items**

<b>Item</b>	<b>Description</b>
[Enable]	Displays whether the break condition is enabled or disabled. The “•” indicates that the breakpoint is enabled.
[File/Line]	Displays the file name and line number where the breakpoint is set.
[Symbol]	Displays the symbol corresponding to the breakpoint address. If no symbol has been defined for the address, a blank is displayed.
[Address]	Displays the address where the breakpoint is set.
[Type]	Displays “PC breakpoint”

Right-clicking in the [Breakpoints] window will open a pop-up menu, through which breakpoints can be set, changed, deleted, enabled, or disabled. The pop-up menu functions are described in table 4.4.

**Table 4.4 [Breakpoints] Window Pop-up Menu Operation**

<b>Menu</b>	<b>Description</b>
[Add]	Sets break conditions. Selecting this menu will display the [Add/Edit Breakpoint] dialog box, enabling break conditions to be set.
[Edit]	Changes break conditions. Select break conditions to be changed and select this menu. The [Add/Edit Breakpoint] dialog box will be displayed, enabling the break condition to be changed.
[Disable] ([Enable])	Enables or disables break conditions. Select break conditions to be enabled or disabled and select this menu.
[Delete]	Clears break conditions. Select break conditions to be cleared and select this menu.
[Del All]	Clears all break conditions.
[Go to Source]	Jumps to the break address in the [Source] window.

### 4.2.3 [Add/Edit Breakpoint] Dialog Box

#### Function:

Sets a breakpoint. This dialog box is displayed when the [Add] or [Edit] is selected in the pop-up menu in the [Breakpoints] window, which is displayed by selecting the [Breakpoints] item on the [View] menu.

#### Window:

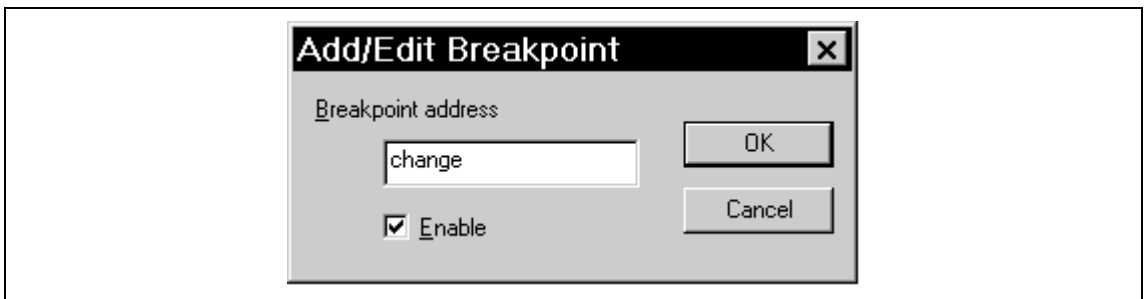

Figure 4.3 [Add/Edit Breakpoint] Dialog Box

#### Description:

The [Add/Edit Breakpoint] dialog box is made up of the components listed in the table below.

Table 4.5 [Add/Edit Breakpoint] Dialog Box Items

Item	Description
[Breakpoint address]	Enter the address or symbol for which a breakpoint is to be set.
[Enable]	The breakpoint is enabled when this box is checked.

After clicking [OK], the breakpoint is set.

#### 4.2.4 [System Status] Window

##### Function:

This window lists information, such as conditions that have been set to the CPU board and execution results. It is displayed by selecting the [Status] item on the [View] menu.

##### Window:

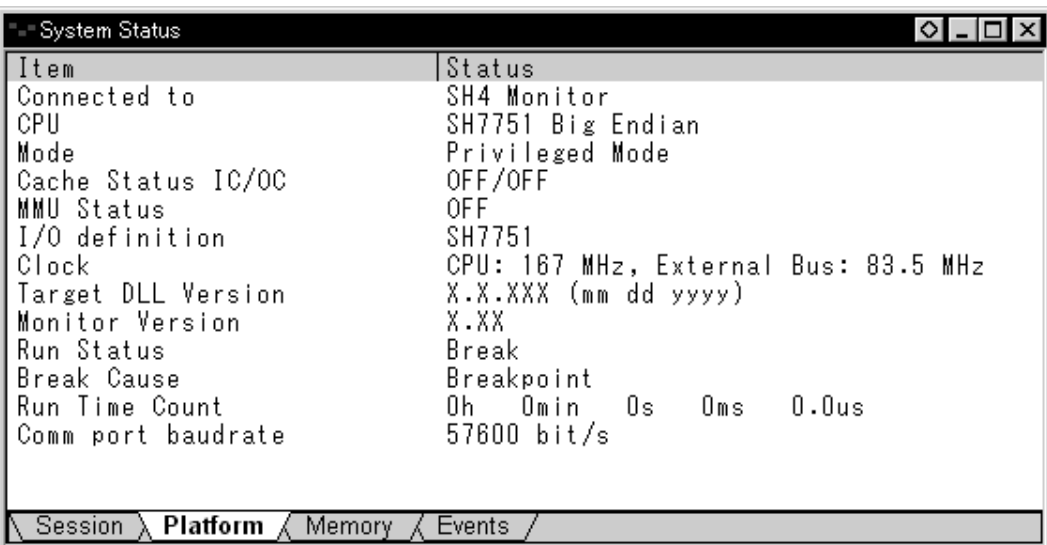

The screenshot shows a window titled "System Status" with a table of system parameters. The table has two columns: "Item" and "Status". The items listed include connection details, CPU information, cache/MMU status, I/O definition, clock speeds, target DLL and monitor versions, run status, break cause, run time count, and communication port baudrate. At the bottom of the window, there is a navigation bar with tabs for "Session", "Platform", "Memory", and "Events".

Item	Status
Connected to	SH4 Monitor
CPU	SH7751 Big Endian
Mode	Privileged Mode
Cache Status IC/OC	OFF/OFF
MMU Status	OFF
I/O definition	SH7751
Clock	CPU: 167 MHz, External Bus: 83.5 MHz
Target DLL Version	X.X.XXX (mm dd yyyy)
Monitor Version	X.XX
Run Status	Break
Break Cause	Breakpoint
Run Time Count	0h 0min 0s 0ms 0.0us
Comm port baudrate	57600 bit/s

Figure 4.4 [System Status] Window

**Description:**

The items listed in the following table are displayed in the [System Status] window.

**Table 4.6 [System Status] Window Display Items**

Sheet	Item	Description
[Session]	Target System	Indicates whether the CPU board is connected or not.
	Session Name	Displays the session file name.
	Program Name	Displays the load module file name.
[Platform]	Connected to	Displays the name of the connected CPU board monitor program.
	CPU	Displays the target CPU and endian setting.
	Mode	Displays the CPU processor mode (privileged mode or user mode).
	Cache Status IC/OC	Shows whether the cache is enabled or disabled.
	MMU Status	Shows whether the MMU is enabled or disabled.
	I/O definition	Displays the selected I/O register definition file.
	Clock	Displays the clock frequency (CPU operating frequency and external bus frequency) being used.
	Target DLL Version	Indicates the version of the target DLL for connection to the CPU board.
	Monitor Version	Displays the monitor program version.
	Run Status	Displays the user program execution status: Run: Being executed Break: Stopped
	Break Cause	Displays the cause of the program stopping at break.
	Run Time Count	Shows the time from the start of the user program to the break. When the run time count function is disabled, "0h 0min 0s 0ms 0.0us" is displayed.
	Comm port baudrate	Indicates the data baud rate for the serial interface.
[Memory]	Target Device Configuration	Not supported by this CPU board.
	System Memory Resources	Not supported by this CPU board.
	Loaded Memory Areas	Shows the area where the load module is loaded.
[Events]	Resources	Shows the number of breakpoints set.

## 4.2.5 [Run Time Count Condition] Dialog Box

### Function:

Specifies the condition for measuring the run time. It is displayed by selecting [Run Time...] from the [View] menu.

### Window:

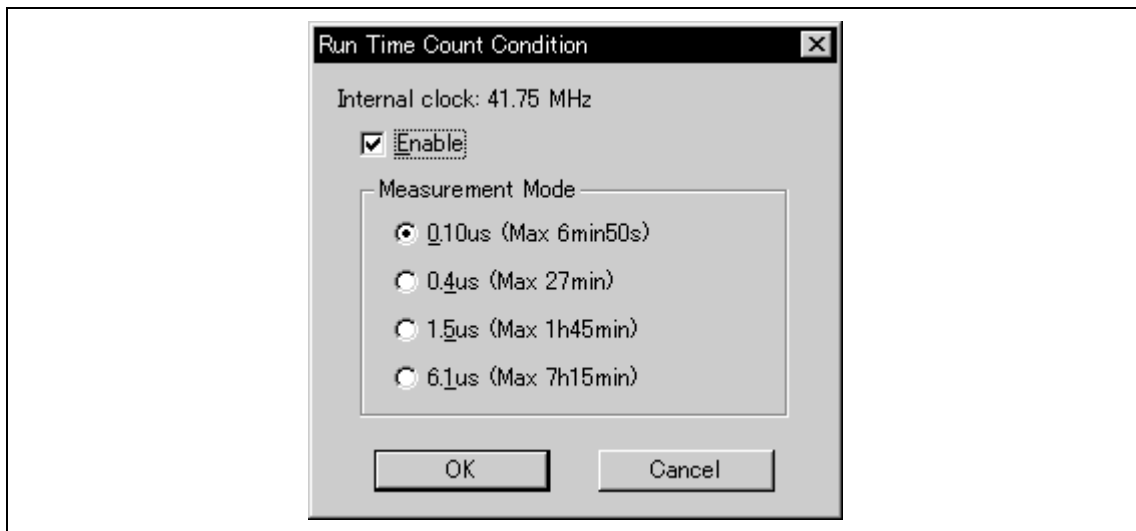

Figure 4.5 [Run Time Count Condition] Window

### Description:

The items listed in table 4.7 can be set in the [Run Time Count Condition] dialog box. The run time can be checked in a message box displayed at break or in the [System Status] window.

Table 4.7 [Run Time Count Condition] Dialog Box Items

Item	Description
Enable	Check this box to enable the run time count function. The default setting is "disable".
Measurement Mode	Select a measurement unit here.

The setting is stored when the [OK] button is clicked.

The selectable measurement units depend on the jumper setting (J23: bus frequency setting) on the CPU board as shown in table 4.8.

**Table 4.8 Selectable Measurement Units**

J23 Setting	Internal Peripheral Module Operating Clock	Measurement Unit	Maximum Measurable Time
Closed	27.83 MHz	0.15 $\mu$ s	Approximately 10 minutes
		0.6 $\mu$ s	Approximately 41 minutes
		2.3 $\mu$ s	Approximately 2 hours 45 minutes
		9.2 $\mu$ s	Approximately 11 hours
Open	41.75 MHz	0.10 $\mu$ s	Approximately 6 minutes 50 seconds
		0.4 $\mu$ s	Approximately 27 minutes
		1.5 $\mu$ s	Approximately 1 hour 45 minutes
		6.1 $\mu$ s	Approximately 7 hours 15 minutes

Note: When the maximum measurable time shown in table 4.8 is exceeded, the measured value will be invalid.

#### 4.2.6 [Cache Control] Dialog Box

**Function:**

Specifies the cache functions. This dialog is displayed on selecting [Cache Control...] from the [View] menu.

**Window:**

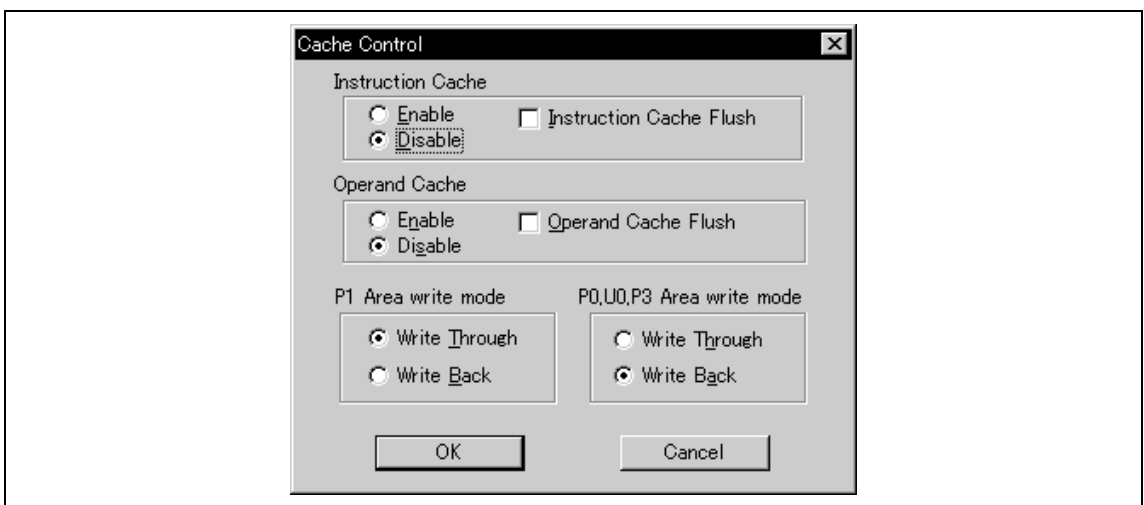

**Figure 4.6 [Cache Control] Dialog Box**

**Description:**

The items listed in table 4.9 are displayed and set in the [Cache Control] dialog box. The cache control register settings are displayed when the dialog box is opened. When the [OK] button is clicked, the settings are sent to the cache control registers.

Operation can be specified separately for the instruction cache and operand cache.

**Table 4.9 [Cache Control] Dialog Box Items**

Item	Description
Instruction Cache	Enables or disables the instruction cache. Check the [Instruction Cache Flush] check box then click the [OK] button to flush all entries from the instruction cache.
Operand Cache	Enables or disables the operand cache. Check the [Operand Cache Flush] check box then click the [OK] button to flush all entries from the operand cache.
P1 Area write mode	Specifies the operating mode (write-through or write-back) for the P1 area.
P0,U0,P3 Area write mode	Specifies the operating mode (write-through or write-back) for the P0, U0, and P3 areas.

**4.2.7 [Simulated I/O Window] Window****Function:**

This window displays data input to or output from the serial line during user program execution. It is valid only during execution of a user program. Serial data output by the user program is displayed in this window.

- Data input from the keyboard of the host computer is displayed in this window in addition to being sent to the CPU board.

This window is displayed on selecting the [Simulated I/O Window] item from the [View] menu.

Right-clicking the mouse on this window displays the following pop-up menu.

[Copy] Copies the text appearing in highlighted to the Windows® clipboard.

[Paste] Pastes the contents of the Windows® clipboard to the [Simulated I/O Window], and sends the same contents to the CPU board.

[Clear Window] Clears the contents of the [Simulated I/O Window] window.

## Window:

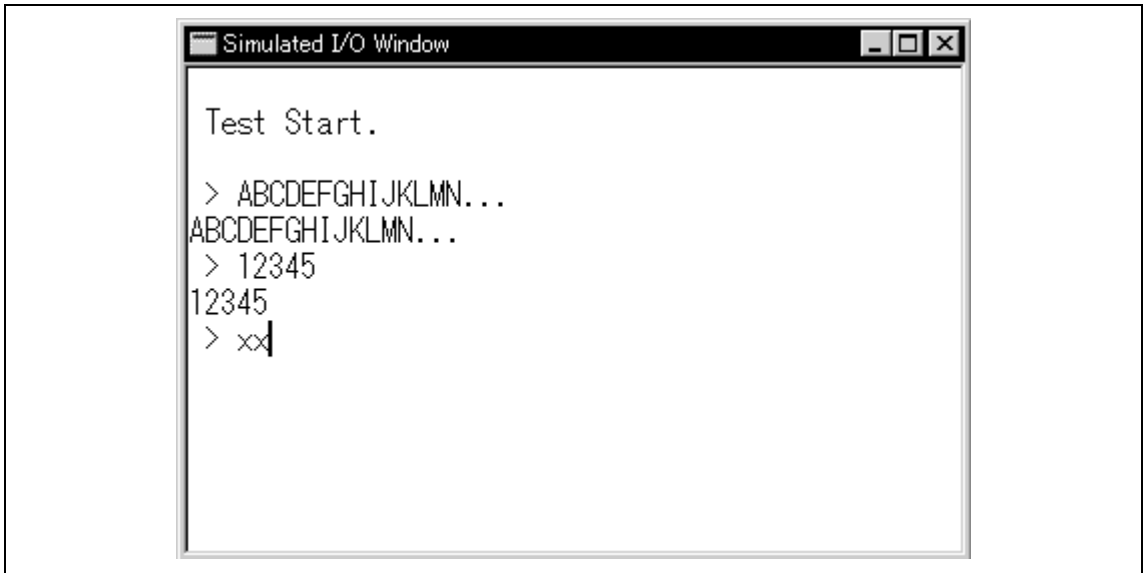

**Figure 4.7 [Simulated I/O Window] Window**

The above is the window displayed when the sample program supplied with this CPU board is used. For details on the sample program, refer to section 7.3, Sample Program.

**Note:** When using the [Simulated I/O Window] window, an interrupt handler must be prepared in the user program. For details on the interrupt handler, refer to section 7, Creation of User Interrupt Handler.

### 4.2.8 [Command Line] Window

The SH7751 CPU board does not guarantee the [Command Line] window operation; do not use the [Command Line] window.

## Section 5 CPU Board Specifications

### 5.1 Block Diagram

A block diagram of the CPU board is shown in figure 5.1.

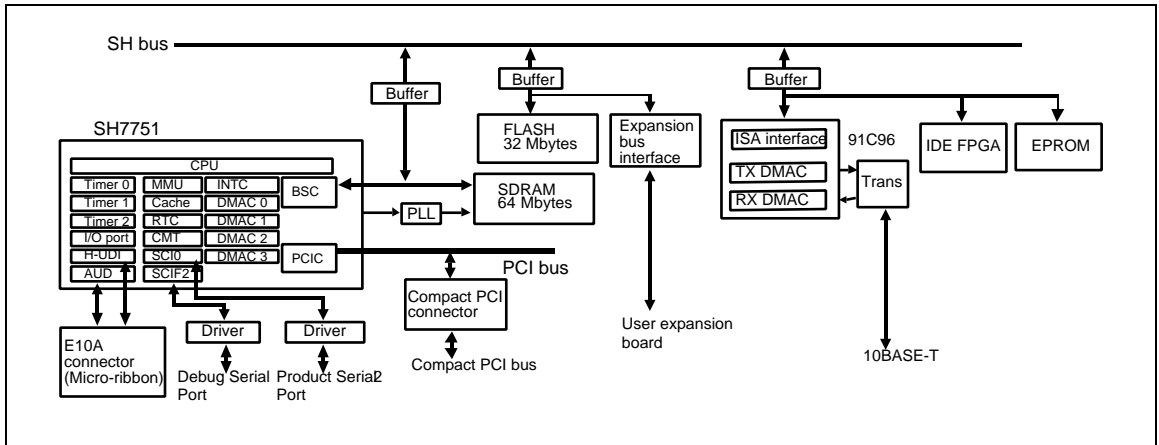

**Figure 5.1 Block Diagram of the CPU board**

## 5.2 Specifications

Table 5.1 lists the components of the CPU board.

**Table 5.1 External Specifications**

Item		Specifications	
Microcomputer (U1)	SH7751	Type name: HD6417751F167 Package: 256-pin QFP	
Operating frequency	CPU internal clock: 167 MHz Bus clock: 83.5 or 55.7 MHz (switchover by jumpers)		
Endian	Little or big endian (switchover by jumpers)		
Memory	RAM (M1, M2)	SDRAM	Capacity: 64 Mbytes Bus width: 32 bits Type number: HM5225165TT-A60 x 2
	ROM (M7)	EPROM (only the socket is mounted)	Capacity: 512 kbytes Bus width: 16 bits Type number: HN27C4096A x 1
	ROM (M3-M6)	Flash memory (monitor program)	Capacity: 32 Mbytes Bus width: 32 bits Type number: G28F640J5-150 x 4
Serial interface (CN15)	One channel: Conforms to RS-232C Transfer rate: 57600 or 115200 bit/s (switchover by jumpers) Connector: 9-pin D-sub connector Connector on CPU board: DELC-J9PAF-20L9 manufactured by Japan Aviation Electronics Industry, Ltd. Cable length: 1.5 m (use the supplied cable)		
LAN interface (CN2)	One channel: 10BASE-T Transfer rate: 10 Mbit/s max. Controller: LAN91C96 manufactured by Standard Microsystems Corporation Configuration ROM: M93C46 manufactured by STMicroelectronics Connector on CPU board: NT10-8SAG-10L9 manufactured by Japan Aviation Electronics Industry, Ltd.		

**Table 5.1 External Specifications (cont)**

Item	Specifications				
User expansion board interface (CN1)	Expansion board connector Connector on CPU board: 53481-1809 manufactured by Molex Incorporated. Connector on user board: 52760-1809 manufactured by Molex Incorporated.				
Compact PCI interface (CN19 and CN20)	System board conforming to PICMG2.0 rev. 2.1. Only J1 and J2 connectors are mounted. Interface voltage: 3.3 V PCI clock: 33 MHz Data bus width: 32 bits Supported expansion slots: Up to four slots Interface connectors J1 connector (CN19): 27-8071-110-011-833 manufactured by Kyocera Elco Corporation J2 connector (CN20): 27-8071-110-010-833 manufactured by Kyocera Elco Corporation				
E10A emulator interface (CN23)	Connector on CPU board: DX20M-36S manufactured by Hirose Electric Co., Ltd.				
Switches	SW1: Power supply switch SW2: Manual reset switch SW3: Power-on reset switch SW4: Abort switch				
External dimensions	<table border="1"> <thead> <tr> <th data-bbox="307 1093 375 1112">Board</th> <th data-bbox="450 1093 852 1112">Width: 233.35 mm, Length: 160 mm</th> </tr> <tr> <th data-bbox="307 1132 389 1151">Product</th> <th data-bbox="450 1132 998 1151">Width: 236 mm, Length: 175 mm, Height: 42 mm</th> </tr> </thead> </table>	Board	Width: 233.35 mm, Length: 160 mm	Product	Width: 236 mm, Length: 175 mm, Height: 42 mm
Board	Width: 233.35 mm, Length: 160 mm				
Product	Width: 236 mm, Length: 175 mm, Height: 42 mm				

### 5.3 Memory Map

Memory map of the CPU board is shown in figure 5.2. Each area of the CPU is allocated as follows:

- Area 0: Monitor program area. Allocated to flash memory. Bus width is 32 bits for flash memory. However, when using the EPROM mode (J25 is closed), the bus width is set to 16 bits.
- Area 1: System register area. The LAN controller (LAN91C96) can be accessed in this area.
- Area 2: User expansion board interface area. The user expansion board can be allocated. Note that when the EPROM mode is used (J25 is closed), flash memory is allocated to this area. In this case, the user expansion board cannot be used in this area.
- Area 3: 64Mbyte SDRAM is allocated. The first 63.5Mbyte area is assigned to the user area and the remaining 0.5Mbyte area is assigned to the monitor program work area. Bus width is 32 bits fixed.
- Area 4: User expansion board interface area. The user expansion board can be allocated.
- Area 5: User expansion board interface area. The user expansion board can be allocated.
- Area 6: User expansion board interface area. The user expansion board can be allocated.

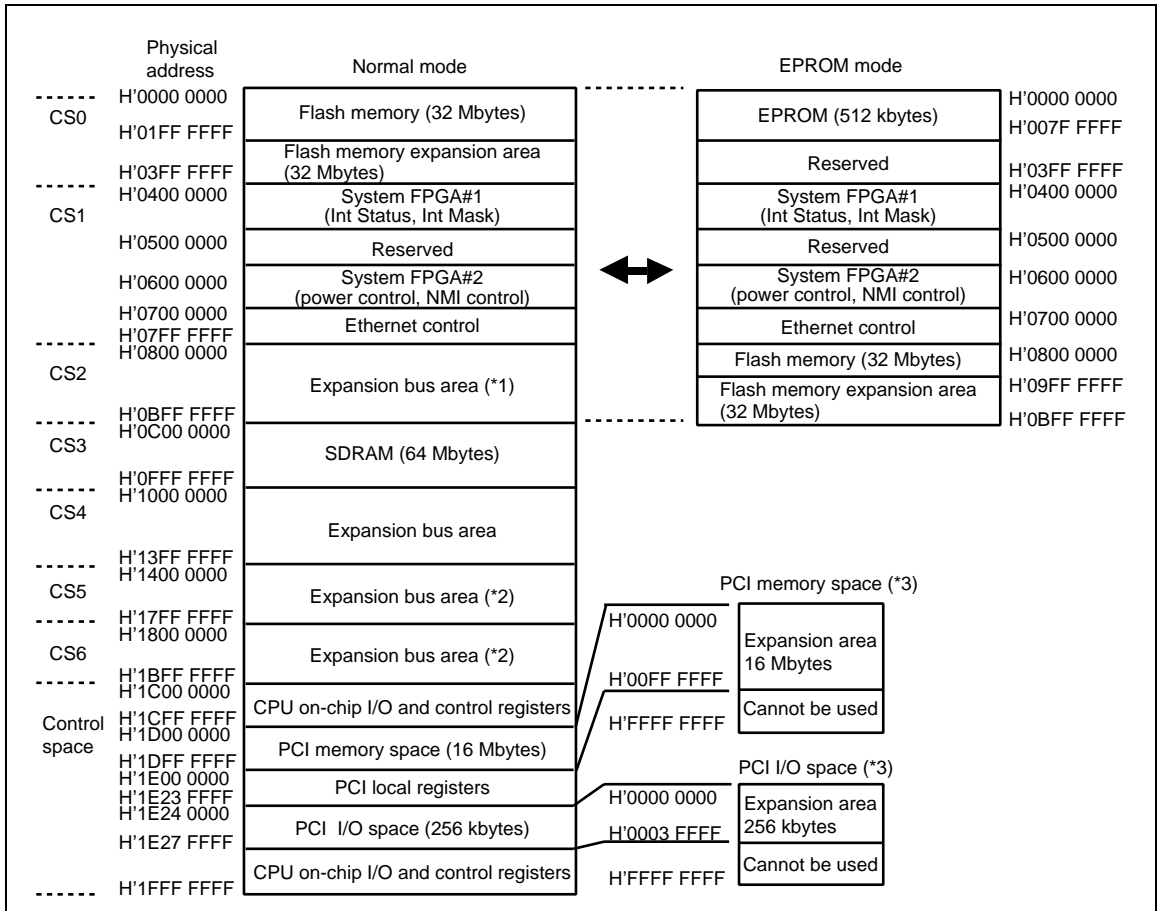

**Figure 5.2 CPU Board Memory Map**

- Notes
1. When the EPROM mode is used, flash memory is allocated to area CS2. In this case, the expansion bus area cannot be accessed.
  2. Accesses to the CS5 and CS6 areas can be enabled or disabled by the setting of the CS56EN bit of NMIMASK.
  3. Address assignment to the PCI memory space and PCI I/O space in this CPU board can be modified by setting the respective SH7751 registers.

## 5.4 External Interface

### 5.4.1 Serial Interface

# WARNING

**Always switch OFF the CPU board and the user system before connecting or disconnecting any CABLES or CONNECTORS. Failure to do so will result in a FIRE HAZARD and will damage the user system and the CPU board or will result in PERSONAL INJURY. The USER PROGRAM will be LOST.**

The CPU board has a serial interface (1 channel) that conforms to RS-232C and can be used as an interface with the host computer. This interface is implemented by using an on-chip serial communication interface (SCIF: serial interface with FIFO) in the CPU. Therefore, when the user wants to directly use the SCIF in the CPU, the user must create an interrupt handler and use the Simulated I/O window. For details, refer to section 7, Creation of User Interrupt Handlers. The connector is a 9-pin D-sub connector, and the interface cable is supplied with the CPU board. A baud rate of 57600 bit/s or 115200 bit/s can be selected. To set the baud rate, refer to section 2.8, Jumpers.

Table 5.2 lists the pin assignment for the serial interface connector. Table 5.3 shows the serial interface specifications. For details on serial interface cable connection, refer to section 2.4, Connecting Cables.

**Table 5.2 Pin Assignment of the Serial Interface Connector**

Pin No.	Signal Name	Description
1	Reserved	No connection
2	RXD	Received serial data
3	TXD	Transmitted serial data
4	DTR	Data terminal ready (connected to DSR on the board)
5	SG	Signal ground
6	DSR	Data set ready (connected to DTR on the board)
7	RTS	Request to send
8	CTS	Clear to send
9	Reserved	No connection

**Table 5.3 Serial Interface Specifications**

Item	Specifications
Synchronization method	Asynchronous method
Transfer rate	57600 or 115200 bit/s (can be switched with jumpers)
Bit configuration	Start bit: 1 bit Stop bit: 1 bit Parity: None Data length: 8 bits Flow control: RTS/CTS control
Controller	On-chip SCIF (serial communication interface with FIFO) in the SH7751
Driver	LT1330CG (manufactured by LINEAR TECHNOLOGY CORP.)
Connector	Connector on CPU board: DELC-J9PAF-20L9 manufactured by Japan Aviation Electronics Industry, Ltd.

Figure 5.3 shows the wiring connection between the host computer (IBM PC compatible machine) serial interface connector and the CPU board interface connector. Figure 5.4 shows the serial interface connector pin arrangement. For details on serial interface cable connection, refer to section 2.4, Connecting Cables.

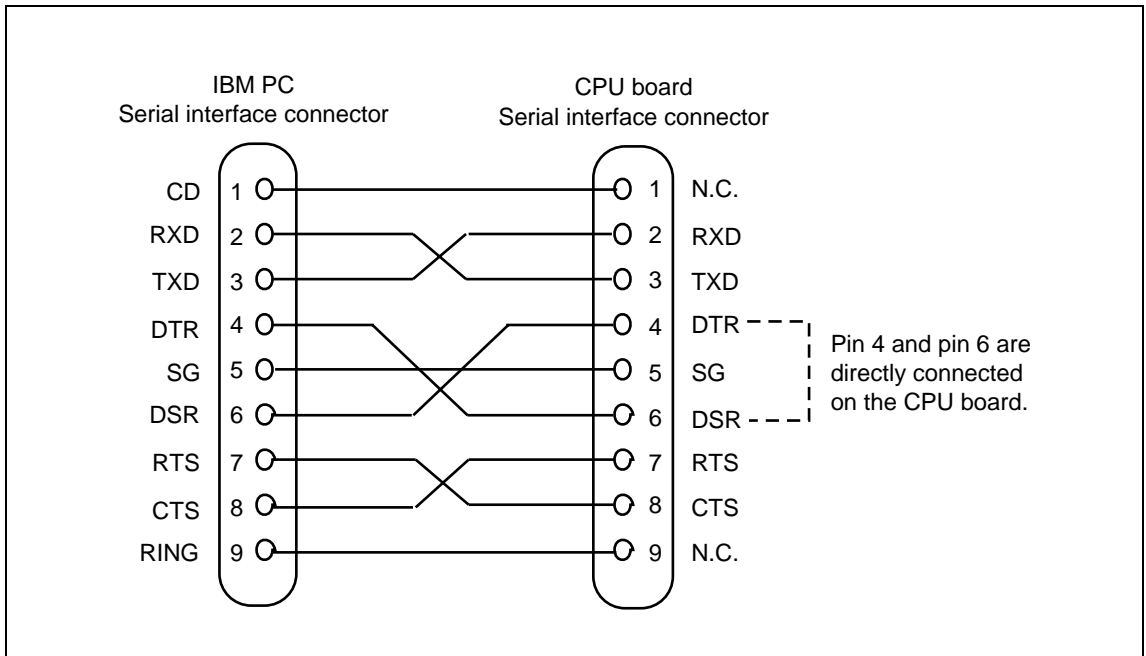

**Figure 5.3 Connection to Host Computer**

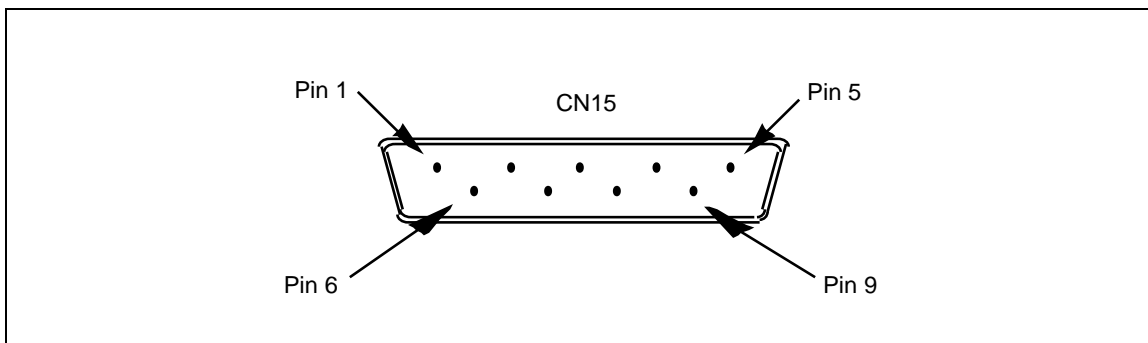

**Figure 5.4 Serial Interface Connector Pin Arrangement**

#### 5.4.2 EPROM Socket Interface

### **⚠ WARNING**

**Always switch OFF the CPU board and the user system before connecting or disconnecting any CABLES or CONNECTORS. Failure to do so will result in a FIRE HAZARD and will damage the user system and the CPU board or will result in PERSONAL INJURY. The USER PROGRAM will be LOST.**

The CPU board has an EPROM socket (M7) for the HN27C4096, through which an ROM-ICE can be connected to the CPU board. Close the J25 and turn on the power to start the CPU board in the EPROM mode. The EPROM socket area is allocated to the 512 kbytes from the start address of area 0. In the EPROM mode, the bus width of area 0 is set to 16 bits.

In this mode, the flash memory for monitor program is allocated to area 2. Table 5.4 lists the pin assignment for the EPROM socket.

**Table 5.4 Pin Assignment of the EPROM Socket**

Pin No.	Signal Name	Pin No.	Signal Name	Pin No.	Signal Name	Pin No.	Signal Name
1	VPP	11	Vss	21	A0	31	A9
2	/CE	12	I/O7	22	A1	32	A10
3	I/O15	13	I/O6	23	A2	33	A11
4	I/O14	14	I/O5	24	A3	34	A12
5	I/O13	15	I/O4	25	A4	35	A13
6	I/O12	16	I/O3	26	A5	36	A14
7	I/O11	17	I/O2	27	A6	37	A15
8	I/O10	18	I/O1	28	A7	38	A16
9	I/O9	19	I/O0	29	A8	39	A17
10	I/O8	20	/OE	30	Vss	40	Vcc

Some types of ROM-ICE use the NMI and RESET signals of the CPU to implement debugging functions. In this CPU board, these signals are assigned to TP56 and TP57.

TP56: Reset input; ORed with the logic on the board to create the \_RESET signal for the CPU.

TP57: NMI input; ORed with the logic on the board to create the \_NMI signal for the CPU. This input can be masked by using the on-board register NMIMASK.

### 5.4.3 LAN Interface

## WARNING

**Always switch OFF the CPU board and the user system before connecting or disconnecting any CABLES or CONNECTORS. Failure to do so will result in a FIRE HAZARD and will damage the user system and the CPU board or will result in PERSONAL INJURY. The USER PROGRAM will be LOST.**

The CPU board has one channel of LAN interface, to which the user application program can access.

The LAN91C96 LAN controller manufactured by Standard Microsystems Corporation is used to support a 10BASE-T interface. The MAC address and configuration information are stored in the EEPROM (M93C46 manufactured by STMicroelectronics) on the CPU board. Be careful not to modify the contents of the EEPROM accidentally. The MAC address in the EEPROM is also displayed on the board.

Note that the monitor program of the CPU board does not include the LAN interface driver; the driver software must be prepared as part of the user program to use the LAN interface. Tables 5.5 to 5.9 list the register specifications of the LAN91C96 LAN controller. For details of the LAN controller, refer to the documents released by Standard Microsystems Corporation.

**Table 5.5 LAN91C96 LAN Controller Register Specifications (Bank 0)**

<b>BANK0 Register</b>	<b>Abbrev.</b>	<b>R/W</b>	<b>Initial Value</b>	<b>Address</b>	<b>Access Size (bit)</b>
Transmit control register	TCR	R/W	0XX0h	07000000	16
EPH status register	EPHSR	R	0000h	07000002	16
Receive control register	RCR	R/W	0000h	07000004	16
Counter register	ECR	R	0000h	07000006	16
Memory information register	MIR	R	1818h	07000008	16
Memory configuration register	MCR	R/W	3300h	0700000A	16
Bank select register	BSR	R/W	33XXh	0700000E	16

**Table 5.6 LAN91C96 LAN Controller Register Specifications (Bank 1)**

<b>BANK1 Register</b>	<b>Abbrev.</b>	<b>R/W</b>	<b>Initial Value</b>	<b>Address</b>	<b>Access Size (bit)</b>
Configuration register	CR	R/W	XXXXh	07000000	16
Base address register	BAR	R	1867h	07000002	16
Individual address register	IAR	R/W	XXXXh	07000004	16
Individual address register	IAR	R/W	XXXXh	07000006	16
Individual address register	IAR	R/W	XXXXh	07000008	16
General address register	GPR	R/W	0000h	0700000A	16
Control register	CTR	R/W	0XXXh	0700000C	16
Bank select register	BSR	R/W	33XXh	0700000E	16

**Table 5.7 LAN91C96 LAN Controller Register Specifications (Bank 2)**

<b>BANK2 Register</b>	<b>Abbrev.</b>	<b>R/W</b>	<b>Initial Value</b>	<b>Address</b>	<b>Access Size (bit)</b>
MMU command register	MMUCR	W	00h	07000000	8
Auto TX start register	AUTOTX	R/W	00h	07000001	8
Packet number register	PNR	R/W	00h	07000002	8
Allocation result register	ARR	R	80h	07000003	8
FIFO ports register	FIFO	R	8080h	07000004	16
Pointer register	PTR	R/W	0000h	07000006	16
Data register	DATA	R/W	XXXXh	07000008	16
Data register	DATA	R/W	XXXXh	0700000A	16
Interrupt status register	IST	R	03h	0700000C	8
Interrupt acknowledge register	ACK	W	XXh	0700000C	8
Interrupt mask register	MSK	R/W	00h	0700000D	8
Bank select register	BSR	R/W	33XXh	0700000E	16

**Table 5.8 LAN91C96 LAN Controller Register Specifications (Bank 3)**

<b>BANK3 Register</b>	<b>Abbrev.</b>	<b>R/W</b>	<b>Initial Value</b>	<b>Address</b>	<b>Access Size (bit)</b>
Multicast table	MT	R/W	00h	07000000	16
Multicast table	MT	R/W	00h	07000001	16
Multicast table	MT	R/W	00h	07000002	16
Multicast table	MT	R/W	00h	07000003	16
Multicast table	MT	R/W	00h	07000004	16
Multicast table	MT	R/W	00h	07000005	16
Multicast table	MT	R/W	00h	07000006	8
Multicast table	MT	R/W	00h	07000007	8
Management interface	MGMT	R/W	3X30h	07000008	16
Revision register	REV	R	3340h	0700000A	16
Early RCV register	ERCV	R	331Fh	0700000C	16
Bank select register	BSR	R/W	33XXh	0700000E	16

**Table 5.9 LAN91C96 LAN Controller Register Specifications (Bank 4)**

<b>BANK4 Register</b>	<b>Abbrev.</b>	<b>R/W</b>	<b>Initial Value</b>	<b>Address</b>	<b>Access Size (bit)</b>
Ethernet configuration option register	ECOR		40h	07000000	8
Ethernet configuration and status register	ECSR		00h	07000001	8
Bank select register	BSR	R/W	33XXh	0700000E	16

#### **5.4.4 User Expansion Board Interface**

The CPU board has a user expansion board interface connector for the user expansion board interface.

The maximum currents that can be supplied through the expansion board interface are shown below. When designing a user expansion board, note that the following values must not be exceeded.

- 5.0V system: 3.0 A
- 3.3V system: 1.2 A

 <b>WARNING</b>
<b>Always switch OFF the CPU board and the user system before connecting or disconnecting any CABLES or CONNECTORS. Failure to do so will result in a FIRE HAZARD and will damage the user system and the CPU board or will result in PERSONAL INJURY. The USER PROGRAM will be LOST.</b>

Figure 5.5 shows the pin arrangement of user expansion board interface connector CN1. Table 5.10 lists the pin assignment of the user expansion board connector CN1. Refer to the CPU hardware manual for those pins that have no numbers in the pin function column. The pin signal level is 3.3 V, which is equivalent to that of the SH7751 CPU. For details on expansion board connection, refer to section 2.4, Connecting the User Expansion Board.



**Figure 5.5 User Expansion Board Interface Connector CN1 Pin Arrangement**

**Table 5.10 Pin Assignment of User Expansion Board Interface Connector CN1**

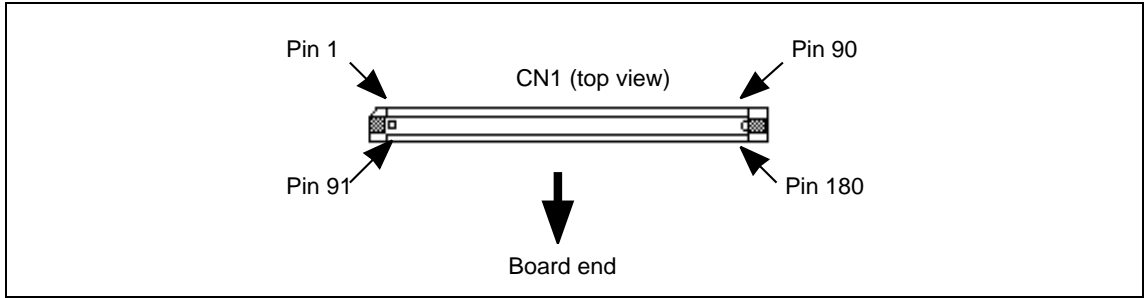
Pin No.	Pin Name	Pin Function	Pin No.	Pin Name	Pin Function	Pin No.	Pin Name	Pin Function
1	+5V		31	GND		61	GND	
2	GND		32	A20	(2)	62	D19	(1)
3	+12V		33	A21	(2)	63	D20	(1)
4	GND		34	A22	(2)	64	D21	(1)
5	+1.8V		35	A23	(2)	65	D22	(1)
6	GND		36	A24	(2)	66	D23	(1)
7	GND		37	GND		67	GND	
8	A0	(2)	38	A25	(2)	68	D24	(1)
9	A1	(2)	39	D0	(1)	69	D25	(1)
10	A2	(2)	40	D1	(1)	70	D26	(1)
11	A3	(2)	41	D2	(1)	71	D27	(1)
12	A4	(2)	42	D3	(1)	72	D28	(1)
13	GND		43	GND		73	GND	
14	A5	(2)	44	D4	(1)	74	D29	(1)
15	A6	(2)	45	D5	(1)	75	D30	(1)
16	A7	(2)	46	D6	(1)	76	D31	(1)
17	A8	(2)	47	D7	(1)	77	STATUS0	
18	A9	(2)	48	D8	(1)	78	STATUS1	
19	GND		49	GND		79	GND	
20	A10	(2)	50	D9	(1)	80	GND	
21	A11	(2)	51	D10	(1)	81	B_CKIO	(12)
22	A12	(2)	52	D11	(1)	82	GND	
23	A13	(2)	53	D12	(1)	83	CKIO	(12)
24	A14	(2)	54	D13	(1)	84	GND	
25	GND		55	GND		85	+5V	
26	A15	(2)	56	D14	(1)	86	GND	
27	A16	(2)	57	D15	(1)	87	+12V	
28	A17	(2)	58	D16	(1)	88	GND	
29	A18	(2)	59	D17	(1)	89	+1.8V	
30	A19	(2)	60	D18	(1)	90	GND	

**Table 5.10 Pin Assignment of Expansion Connector CN1 (cont)**

Pin No.	Pin Name	Pin Function	Pin No.	Pin Name	Pin Function	Pin No.	Pin Name	Pin Function
91	+5V		121	+3.3V		151	EBREQ0A#	(10)
92	GND		122	IRL2#	(7)	152	EBREQ0B#	(10)
93	+12V		123	TCK	(6)	153	TCLK	
94	GND		124	TMS	(6)	154	STBY#	
95	+1.8V		125	+3.3V		155	FLRDY	
96	GND		126	TDO	(6)	156	RXD2	(5)
97	+3.3V		127	ASEBREAK#	(6)	157	+3.3V	
98	WE0#		128	CS0#		158	Mode5	
99	WE1#		129	CS1#		159	CTS2	(5)
100	WE2#		130	CS2#		160	+3.3V	
101	WE3#		131	CS4#		161	RD#	
102	BS#		132	CS5#		162	RDWR#	
103	RXD0		133	+3.3V		163	IRL0#	
104	TXD2	(5)	134	EBACK2#	(10)	164	IRL1#	
105	+3.3V		135	CS6#		165	IRL3#	
106	TRST#	(6)	136	CE2A#		166	RDY	(9)
107	IOIS16		137	BREQ#	(4)	167	MRESET#	(8)
108	SCK2		138	DRAK0		168	RESET#	(8)
109	+3.3V		139	DREQ0#		169	+3.3V	
110	CS3#	(11)	140	+3.3V		170	+3.3V	
111	RTS2	(5)	141	DACK0		171	NMI#	(8)
112	+3.3V		142	DRAK1		172	GND	
113	CE2B#		143	DREQ1#		173	N.C	
114	EBREQ2#	(10)	144	DACK1		174	+3.3V	
115	EBREQ3#	(10)	145	+3.3V		175	+5V	
116	EBACK0#	(10)	146	SCK0		176	GND	
117	TXD0		147	+3.3V		177	+12V	
118	EXINT3#		148	BACK#	(4)	178	GND	
119	EXINT4#		149	EBACK3#	(10)	179	+1.8V	
120	TDI	(6)	150	RESETOUT#	(3)	180	GND	

Note: Some signals are converted and input to the CPU or output to the user expansion board interface connector as follows:

- (1) D[31:0]: See figure 5.9.
- (2) A[25:0]: See figure 5.9.
- (3) RESETOUT#: The reset signal input to the CPU is directly output. Do not drive these signals from the user expansion board.
- (4) BREQ# and BACK#: The CPU signals are directly connected to the connector pins. Do not drive these signals from the user expansion board. To obtain the bus mastership, use the EBREQx and EBACKx signals.
- (5) SCIF-related signals: The HDI uses these signals to communicate with the host computer. Do not drive these signals from the user expansion board.
- (6) H-UDI-related signals: The E10A emulator uses these signals. Do not drive these signals from the user expansion board.
- (7) IRL2: The CPU signal is directly connected to the connector pin. Do not drive this signal from the user expansion board. To request external interrupts, use the IRL0, IRL1, IRL3, EXINT3, and EXINT4 signals.
- (8) RESET#, MRESET#, and NMI: ORed with the related logic on the CPU board, then input to the CPU. Refer to figure 5.9.
- (9) RDY: Pulled down on the CPU board. Control the signal so that it goes high at wait cycle insertion and enters the high-impedance state in other cases.
- (10) Bus release signals: These signals go through the related logic on the CPU board, and are used to generate the BREQ# signal for the CPU. For the bus release timing, refer to figures 5.6 and 5.7.
- (11) CS3: Signal for monitoring the status on the CPU board. This signal is used by the CPU board; do not drive this signal from the user expansion board.
- (12) CKIO and B\_CKIO: As the CKIO output from the CPU is output to the user expansion board interface through an external PLL, no phase error is guaranteed (150 ps max.). As the B\_CKIO output from the CPU is output to the user expansion board interface through a bus buffer, the signal has a high drivability but a large delay (3.6 ns max.).

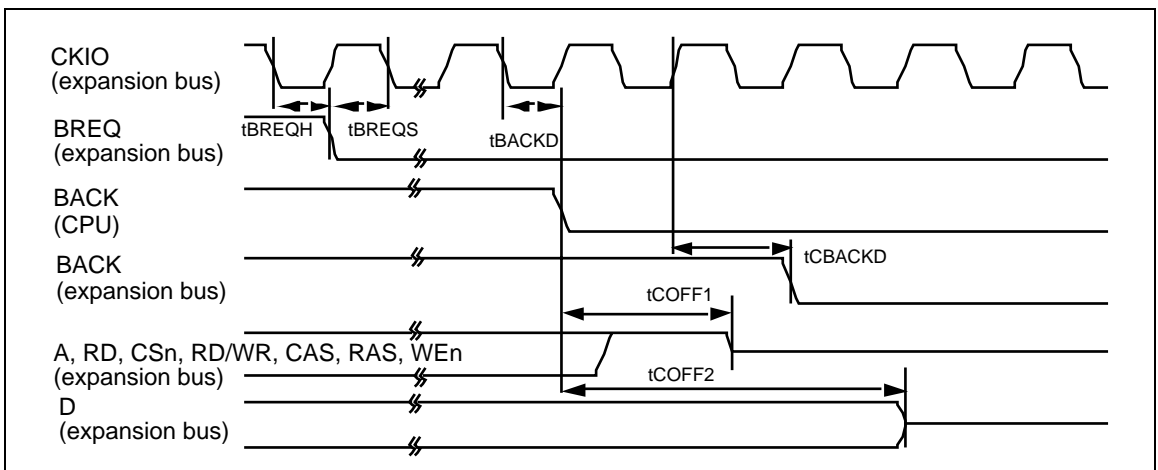
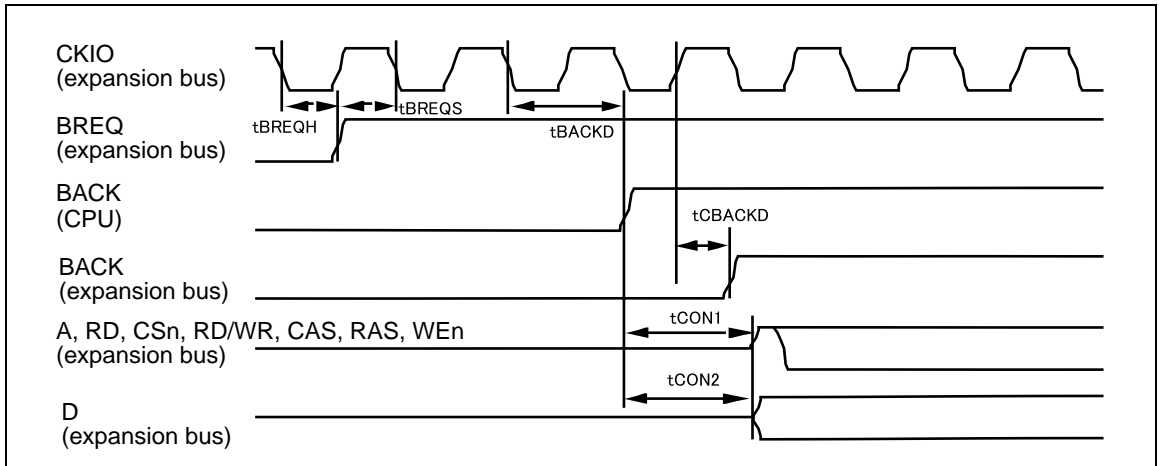

Figure 5.6 Bus Release Timing (1)

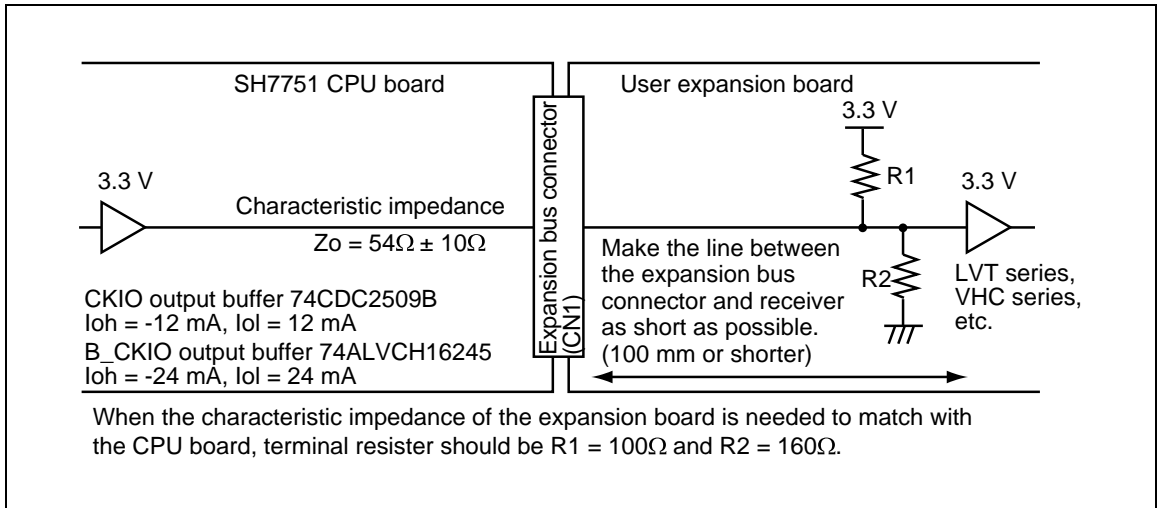

**Figure 5.7 Bus Release Timing (2)**

**Table 5.11 AC Specifications**

Parameter	Minimum	Maximum
tBREQH	1.5 ns	—
tBREQS	6.0 ns	—
tBACKD	=tBACKD	=tBACKD
tCBACKD	—	10.0 ns
tCOFF1	—	8.0 ns
tCOFF2	—	17.0 ns
tCON1	—	8.0 ns
tCON2	—	17.0 ns

Note: =: Equivalent to CPU AC specifications



**Figure 5.8 Example of CKIO Terminal Resistor Connection**

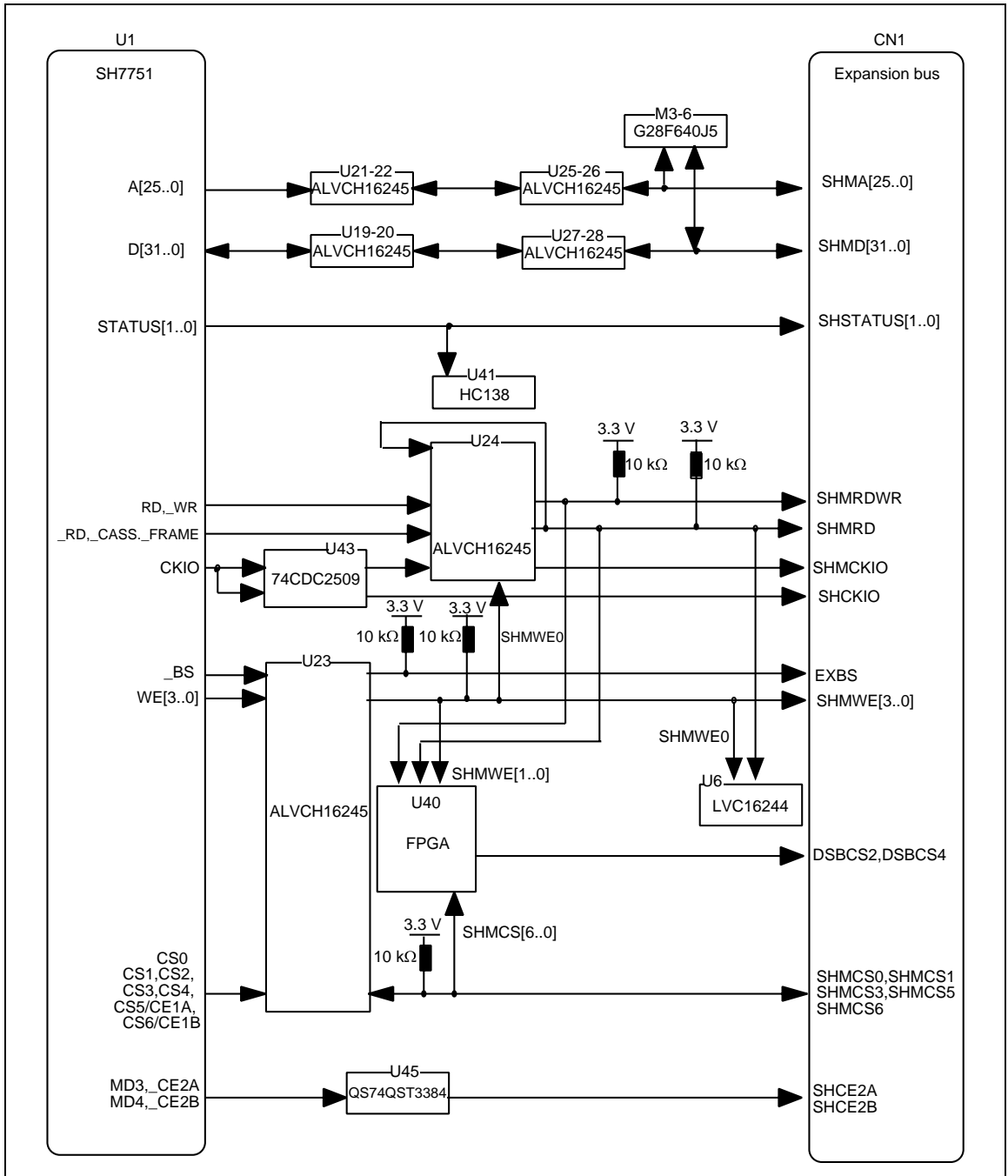

**Figure 5.9 Configuration of User Expansion Board Interface Circuit (CN1)-1**

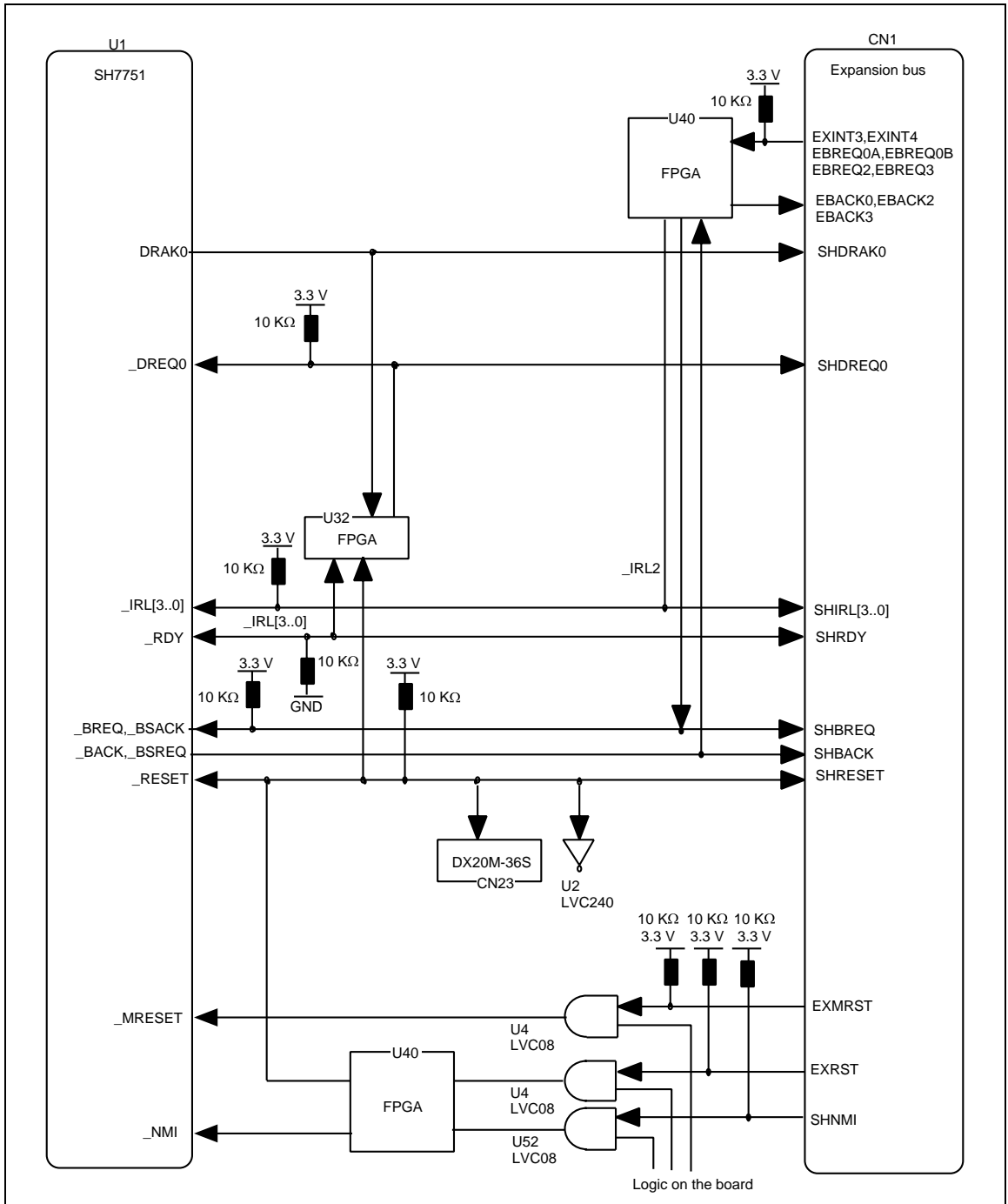

**Figure 5.10 Configuration of User Expansion Board Interface Circuit (CN1)-2**

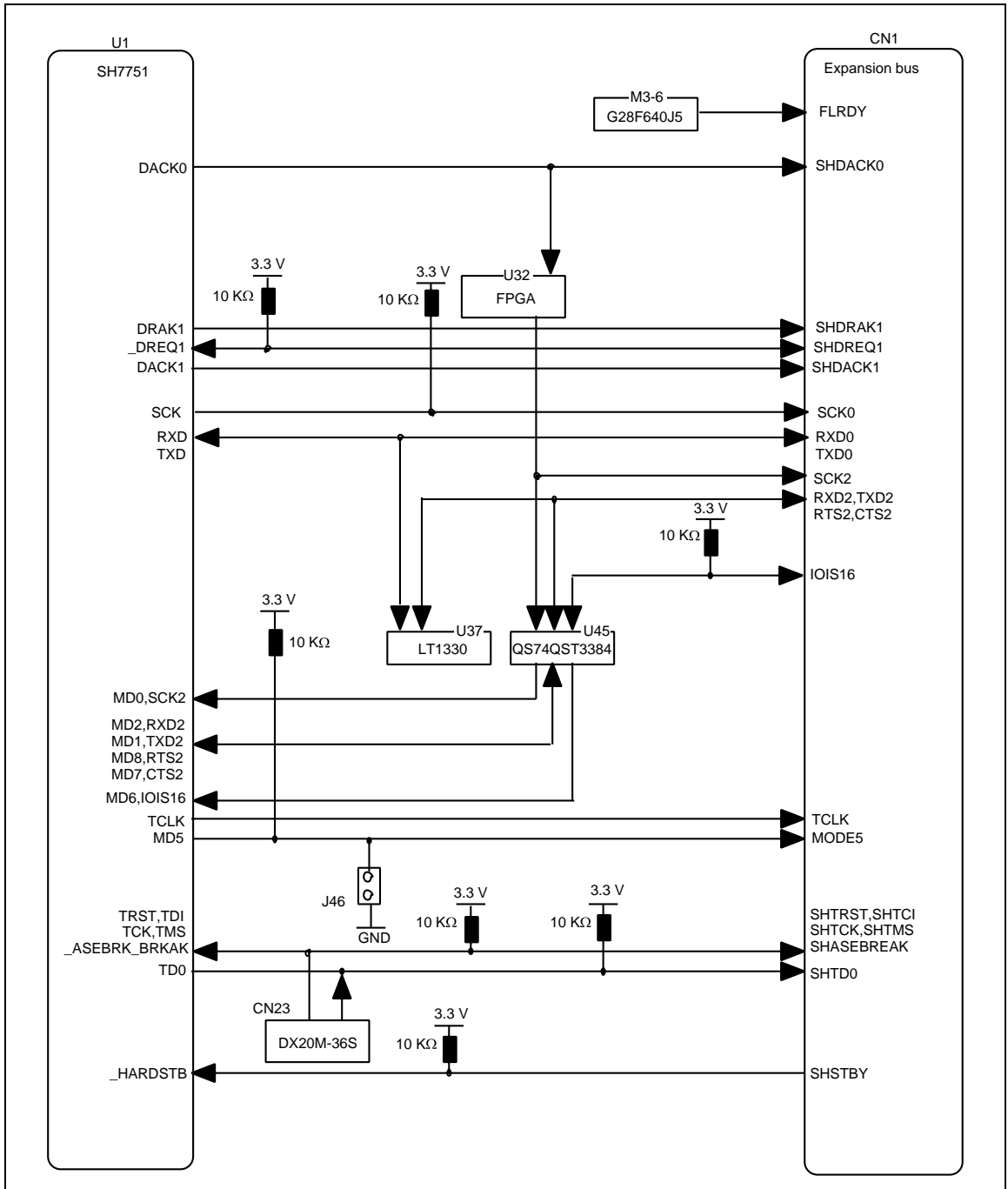

**Figure 5.11 Configuration of User Expansion Board Interface Circuit (CN1)-3**

### 5.4.5 PCI Interface

This board is provided with the compact PCI interface using the on-chip PCI bridge in the SH7751. The 33MHz, 32bit, 3.3V PCI interface is supported.

This CPU board is not provided with PCI drivers. When using the PCI interface, you must provide your own driver software.

Figure 5.12 shows the pin arrangements for the compact PCI connectors. Pin assignments for the compact PCI connectors are listed in tables 5.12 and 5.13. Refer to the CPU hardware manual for those pins that have no numbers in the pin function column. The pin signal level is 3.3 V, which is equivalent to that of the SH7751 CPU.

 **WARNING**

- 1. Always switch OFF the CPU board and the compact PCI backplane before connecting or disconnecting any CABLES or CONNECTORS. Failure to do so will result in a FIRE HAZARD and will damage the PCI system and the CPU board or will result in PERSONAL INJURY. The USER PROGRAM will be LOST.**
  
- 2. Do not insert any other boards into the two slots next to the component side (PCI connector side) of the CPU board when the CPU board is inserted into the PCI backplane. Failure to do so will result in a FIRE HAZARD due to contact between the CPU board and another board, and will damage the PCI system and the CPU board or will result in PERSONAL INJURY. The USER PROGRAM will be LOST.**

Note: Before connecting the CPU board to the compact PCI backplane, turn off SW1 to separate the 3.3V generator on the CPU board. In this case, the CPU board receives the 5V and 3.3V power from the backplane and operates with the 3.3V interface (see figure 5.13).

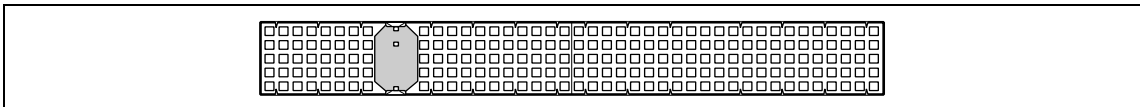

Figure 5.12 Compact PCI interface CN19 and CN20 Pin Arrangements

**Table 5.12 Compact PCI Interface J1 Connector (CN19) Pin Assignments**

Pin No.	Pin Name	Pin Function	Pin No.	Pin Name	Pin Function	Pin No.	Pin Name	Pin Function	Pin No.	Pin Name	Pin Function	Pin No.	Pin Name	Pin Function
A1	5V		B1	-12V		C1	TRST		D1	12V		E1	5V	
A2	TCK		B2	5V		C2	TMS		D2	TDO		E2	TDI	
A3	INTA	(1)	B3	INTB	(1)	C3	INTC	(1)	D3	5V		E3	INTD	(1)
A4	Reserve		B4	GND		C4	V(I/O)	(7)	D4	INTP	(6)	E4	INTS	(6)
A5	Reserve		B5	Reserve		C5	RST		D5	GND		E5	GNT	
A6	REQ		B6	GND		C6	3.3V		D6	CLK		E6	AD31	
A7	AD30		B7	AD29		C7	AD28		D7	GND		E7	AD27	
A8	AD26		B8	GND		C8	V(I/O)	(7)	D8	AD25		E8	AD24	
A9	C/BE3		B9	IDSEL		C9	AD23		D9	GND		E9	AD22	
A10	AD21		B10	GND		C10	3.3V		D10	AD20		E10	AD19	
A11	AD18		B11	AD17		C11	AD16		D11	GND		E11	C/BE2	
A12			B12			C12			D12			E12		
A13			B13			C13			D13			E13		
A14			B14			C14			D14			E14		
A15	3.3V		B15	FRAME		C15	IRDY		D15	GND		E15	TRDY	
A16	DEVSEL		B16	GND		C16	V(I/O)	(7)	D16	STOP		E16	LOCK	
A17	3.3V		B17	SDONE		C17	SBO		D17	GND		E17	PERR	
A18	SERR		B18	GND		C18	3.3V		D18	PAR		E18	C/BE1	
A19	3.3V		B19	AD15		C19	AD14		D19	GND		E19	AD13	
A20	AD12		B20	GND		C20	V(I/O)	(7)	D20	AD11		E20	AD10	
A21	3.3V		B21	AD9		C21	AD8		D21	M66EN		E21	C/BE0	
A22	AD7		B22	GND		C22	3.3V		D22	AD6		E22	AD5	
A23	3.3V		B23	AD4		C23	AD3		D23	5V		E23	AD2	
A24	AD1		B24	5V		C24	V(I/O)	(7)	D24	AD0		E24	ACK64	(2)
A25	5V		B25	REQ64	(2)	C25	ENUM	(4)	D25	3.3V		E25	5V	

**Table 5.13 Compact PCI Interface J2 Connector (CN20) Pin Assignments**

Pin No.	Pin Name	Pin Function	Pin No.	Pin Name	Pin Function	Pin No.	Pin Name	Pin Function	Pin No.	Pin Name	Pin Function	Pin No.	Pin Name	Pin Function
A1	CLK1		B1	GND		C1	REQ1		D1	GNT1		E1	REQ2	
A2	CLK2		B2	CLK3		C2	SYSEN		D2	GNT2		E2	REQ3	
A3	CLK4		B3	GND		C3	GNT3		D3	REQ4	(3)	E3	GNT4	(3)
A4	V(I/O)	(7)	B4	Reserve		C4	C/BE7	(2)	D4	GND		E4	C/BE6	(2)
A5	C/BE5	(2)	B5	GND		C5	V(I/O)	(7)	D5	C/BE4	(2)	E5	PAR64	(2)
A6	AD63	(2)	B6	AD62	(2)	C6	AD61	(2)	D6	GND		E6	AD60	(2)
A7	AD59	(2)	B7	GND		C7	V(I/O)	(7)	D7	AD58	(2)	E7	AD57	(2)
A8	AD56	(2)	B8	AD55	(2)	C8	AD54	(2)	D8	GND		E8	AD53	(2)
A9	AD52	(2)	B9	GND		C9	V(I/O)	(7)	D9	AD51	(2)	E9	AD50	(2)
A10	AD49	(2)	B10	AD48	(2)	C10	AD47	(2)	D10	GND		E10	AD46	(2)
A11	AD45	(2)	B11	GND		C11	V(I/O)	(7)	D11	AD44	(2)	E11	AD43	(2)
A12	AD42	(2)	B12	AD41	(2)	C12	AD40	(2)	D12	GND		E12	AD39	(2)
A13	AD38	(2)	B13	GND		C13	V(I/O)	(7)	D13	AD37	(2)	E13	AD36	(2)
A14	AD35	(2)	B14	AD34	(2)	C14	AD33	(2)	D14	GND		E14	AD32	(2)
A15	Reserve		B15	GND		C15	FAL	(4)	D15	REQ5	(3)	E15	GNT5	(3)
A16	Reserve		B16	Reserve		C16	DEG	(4)	D16	GND		E16	Reserve	
A17	Reserve		B17	GND		C17	PRST	(5)	D17	REQ6	(3)	E17	GNT6	(3)
A18	Reserve		B18	Reserve		C18	Reserve		D18	GND		E18	Reserve	
A19	GND		B19	GND		C19	Reserve		D19	Reserve		E19	Reserve	
A20	CLK5		B20	GND		C20	Reserve		D20	GND		E20	Reserve	
A21	CLK6		B21	GND		C21	Reserve		D21	Reserve		E21	Reserve	
A22	GA4		B22	GA3		C22	GA2		D22	GA1		E22	GA0	

Note: Some signals are converted and input to the CPU or output to the compact PCI connectors, and some pins do not work because part of the PCI functions is not supported by the CPU board, as follows:

- (1) INTA to INTD: The signals are connected to the IRL2 of the CPU through the logic on the CPU board. For details, refer to section 5.5, On-Board Registers.
- (2) 64bit bus signals: NC on the CPU board. If necessary, deal with those signals appropriately on the expansion board. Note that ACK64# and REQ64# are pulled up on the CPU board.
- (3) Signals for slots 6 to 8: Pulled up. No board can be connected to these slots.
- (4) Signals for hot swapping: Pulled up. These pins do not work.
- (5) PRST#: ORed with the related logic on the CPU board, then input to the CPU. Refer to figure 5.14.
- (6) INTP# and INTS#: NC on the CPU board. If necessary, deal with those signals appropriately on the expansion board.
- (7) V(I/O): The CPU board does not use this signal. Note that a decoupling capacitor is inserted between this pin and GND.

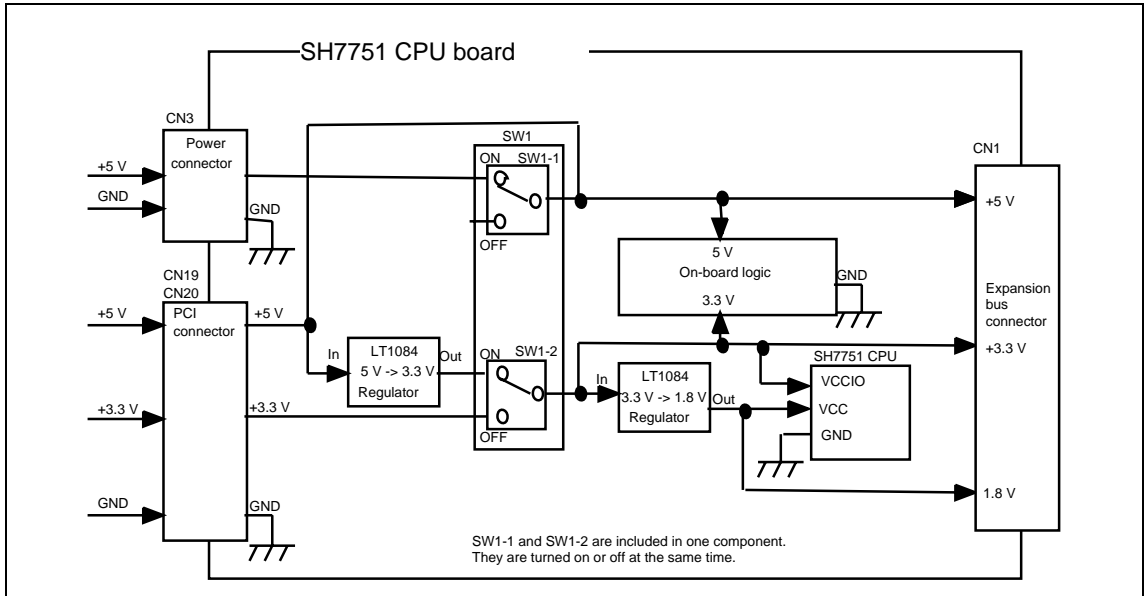

**Figure 5.13 CPU Board Power Supply Lines**

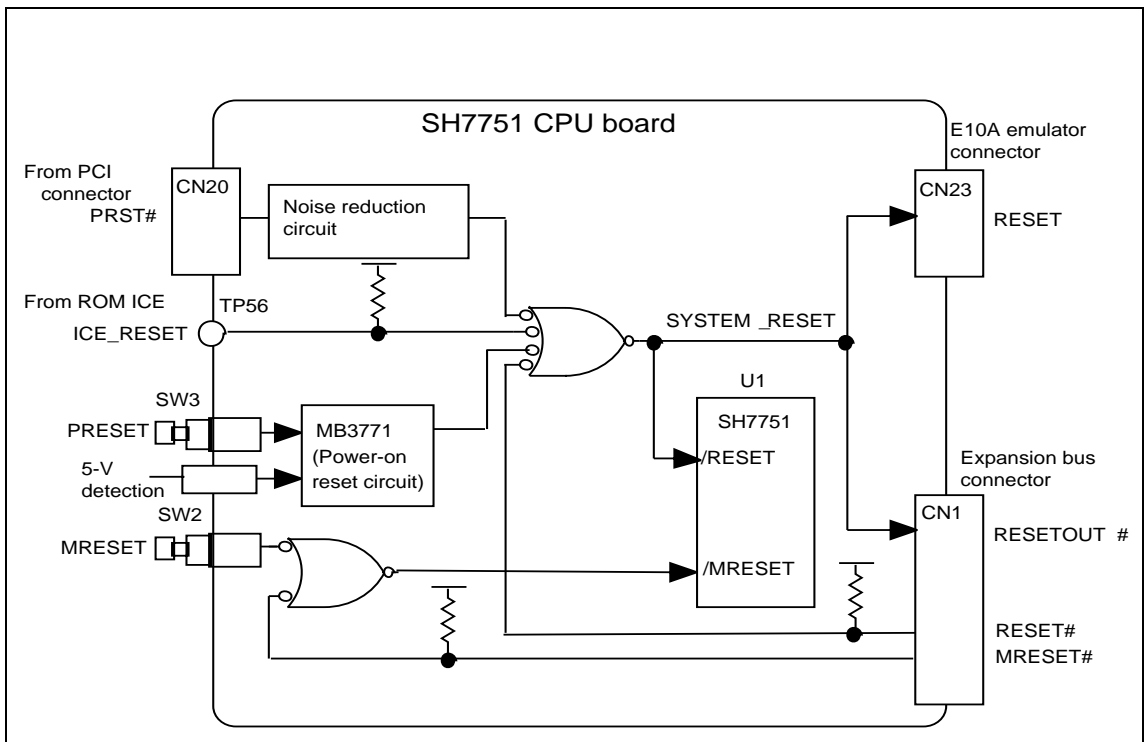

**Figure 5.14 Reset Signal Lines**

## 5.5 On-Board Registers

The CPU board has on-board registers to control interrupts from the external interface. These register contents can be modified by user program. Table 5.14 lists the on-board registers.

**Table 5.14 On-Board Registers**

Register Name	Formal Name	R/W	Address
PINT	PCI interrupt source register	R	H'04000000
PINTMASK	PCI interrupt mask register	R/W	H'04000002
EXINT	External interrupt source register	R	H'04000004
EXINTMASK	External interrupt mask register	R/W	H'04000006
NMIMASK	NMI mask register	R/W	H'04000008

[1] PCI interrupt source register (PINT)

Bit	15	14	13	12	11	10	9	8
Name	Not used	Not used	Not used	Not used	PINT3	PINT2	PINT1	PINT0
R/W	R	R	R	R	R	R	R	R
Initial value	—	—	—	0	—	—	—	—

Bit	7	6	5	4	3	2	1	0
Name	Not used	Not used	Not used	Not used	Not used	Not used	Not used	Not used
R/W	R	R	R	R	R	R	R	R
Initial value	—	—	—	—	—	—	—	—

—: Undetermined

This register monitors the signal levels of the compact PCI interface interrupt lines. When an IRL2 interrupt is requested to the CPU, the source of the interrupt can be determined by reading this register. To clear the interrupt source, access to the corresponding expansion board controller.

Bit 11: PINT3

- 0: PCI INTD signal driven low (interrupt requested)
- 1: PCI INTD signal driven high (interrupt not requested)

Bit 10: PINT2

- 0: PCI INTC signal driven low (interrupt requested)
- 1: PCI INTC signal driven high (interrupt not requested)

Bit 9: PINT1

- 0: PCI INTB signal driven low (interrupt requested)
- 1: PCI INTB signal driven high (interrupt not requested)

Bit 8: PINT0

- 0: PCI INTA signal driven low (interrupt requested)
- 1: PCI INTA signal driven high (interrupt not requested)

[2] PCI interrupt mask register (PINTMASK)

Bit	15	14	13	12	11	10	9	8
Name	Not used	Not used	Not used	Not used	PINTMA SK3	PINTMA SK2	PINTMA SK1	PINTMA SK0
R/W	R	R	R	R	R/W	R/W	R/W	R/W
Initial value	—	—	—	0	0	0	0	0

Bit	7	6	5	4	3	2	1	0
Name	Not used	Not used	Not used	Not used	Not used	Not used	Not used	Not used
R/W	R	R	R	R	R	R	R	R
Initial value	—	—	—	—	—	—	—	—

—: Undetermined

This register masks interrupt input from the compact PCI interface. When a PINT bit becomes 0 while the corresponding bit in this register is set to 1, the IRL2 signal is input to the CPU.

Bit 11: PINTMASK3

- 0: Masks the PCI INTD interrupt
- 1: Accepts the PCI INTD interrupt

Bit 10: PINTMASK2

- 0: Masks the PCI INTC interrupt
- 1: Accepts the PCI INTC interrupt

Bit 9: PINTMASK1

- 0: Masks the PCI INTB interrupt
- 1: Accepts the PCI INTB interrupt

Bit 8: PINTMASK0

- 0: Masks the PCI INTA interrupt
- 1: Accepts the PCI INTA interrupt

[3] External interrupt source register (EXINT)

Bit	15	14	13	12	11	10	9	8
Name	Not used	Not used	Not used	EXINT4	EXINT3	Reserved	Reserved	EXINT0
R/W	R	R	R	R	R	R	R	R
Initial value	—	—	—	—	—	1	1	—

Bit	7	6	5	4	3	2	1	0
Name	Not used	Not used	Not used	Not used	Not used	Not used	Not used	Not used
R/W	R	R	R	R	R	R	R	R
Initial value	—	—	—	—	—	—	—	—

—: Undetermined

This register monitors the signal levels of the external interrupt lines. When an IRL2 interrupt is requested to the CPU, the source of the interrupt can be determined by reading this register. To clear the interrupt source, access to the corresponding resource that has generated the interrupt.

Bit 12: EXINT4

- 0: User expansion board interface EXINT4 signal driven low (interrupt requested)
- 1: User expansion board interface EXINT4 signal driven high (interrupt not requested)

Bit 11: EXINT3

- 0: User expansion board interface EXINT3 signal driven low (interrupt requested)
- 1: User expansion board interface EXINT3 signal driven high (interrupt not requested)

Bit 10: Reserved

Always read as 1

Bit 9: Reserved

Always read as 1

Bit 8: EXINT0

- 0: Serial interface DCD signal driven low (interrupt requested)
- 1: Serial interface DCD signal driven high (interrupt not requested)

[4] External interrupt mask register (EXINTMASK)

Bit	15	14	13	12	11	10	9	8
Name	Not used	Not used	Not used	EXINTM ASK4	EXINTM ASK3	Reserved	Reserved	EXINTM ASK0
R/W	R	R	R	R/W	R/W	R/W	R/W	R/W
Initial value	—	—	—	0	0	0	0	0

Bit	7	6	5	4	3	2	1	0
Name	Not used	Not used	Not used	Not used	Not used	Not used	Not used	Not used
R/W	R	R	R	R	R	R	R	R
Initial value	—	—	—	—	—	—	—	—

—: Undetermined

This register masks external interrupt input. When an EXINT bit becomes 0 while the corresponding bit in this register is set to 1, the IRL2 signal is input to the CPU.

Bit 12: EXINTMASK4

- 0: Masks the user expansion board interface EXINT4 interrupt
- 1: Accepts the user expansion board interface EXINT4 interrupt

Bit 11: EXINTMASK3

- 0: Masks the user expansion board interface EXINT3 interrupt
- 1: Accepts the user expansion board interface EXINT3 interrupt

Bit 10: Reserved

Always write 0.

Bit 9: Reserved

Always write 0.

Bit 8: EXINTMASK0

- 0: Masks the serial interface DCD interrupt
- 1: Accepts the serial interface DCD interrupt

[5] NMI interrupt mask register (NMIMASK)

Bit	15	14	13	12	11	10	9	8
Name	Not used	Not used	Not used	Not used	Not used	CS56EN	SWNMIMASK	EXNMIMASK
R/W	R	R	R	R	R	R/W	R/W	R/W
Initial value	—	—	—	0	0	0	0	0

Bit	7	6	5	4	3	2	1	0
Name	Not used	Not used	Not used	Not used	Not used	Not used	Not used	Not used
R/W	R	R	R	R	R	R	R	R
Initial value	—	—	—	—	—	—	—	—

—: Undetermined

This register masks the input from the abort switch and the NMI input from the user expansion board. It also specifies whether the CS5 and CS6 areas are released to the user expansion bus.

Bit 10: CS56EN

- 1: Outputs CS5 and CS6 area accesses to the expansion bus.
- 0: Does not output CS5 and CS6 area accesses to the expansion bus.

Bit 9: SWNMIMASK

- 1: When the SW4 (abort switch) is pressed, an NMI signal is input to the CPU.
- 0: When the SW4 is pressed, no NMI signal is input to the CPU (execution cannot be aborted).

Bit 8: EXNMIMASK

- 1: Enables the NMI signal to be input from the EXNMI (expansion bus) and ICE\_NMI (the test pin for ROM-ICE).
- 0: Masks the NMI signal from the EXNMI and ICE\_NMI.

## 5.6 E10A Emulator Interface

The CPU board is equipped with a Hitachi-UDI port connector (CN23) to which an SH7751 E10A emulator can be connected. SH7751 H-UDI and AUD signals are connected directly to this connector.

Figure 5.15 shows the pin arrangement of the Hitachi-UDI port connector (CN23). Table 5.15 shows the pin assignment for the Hitachi-UDI port connector (CN23).

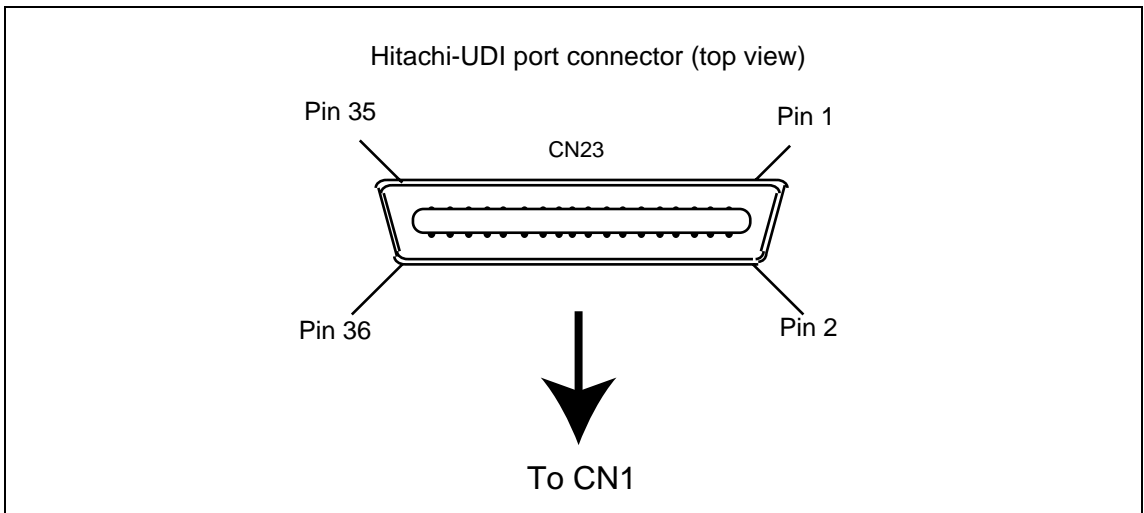

**Figure 5.15 Hitachi-UDI Port Connector (CN23) Pin Arrangement**

**Table 5.15 Hitachi-UDI Port Connector (CN23) Pin Assignment**

Pin No.	Signal Name	Input/Output	Pin No.	Signal Name	Input/Output
1	AUDCK	I/O	19	TMS	I
2	GND		20	GND	
3	AUDATA0	I/O	21	TRST	I
4	GND		22	GND	
5	AUDATA1	I/O	23	TDI	I
6	GND		24	GND	
7	AUDATA2	I/O	25	TDO	O
8	GND		26	GND	
9	AUDATA3	I/O	27	ASEBRKAK	I
10	GND		28	GND	
11	AUDSYNC	I/O	29	NC	
12	GND		30	GND	
13	NC		31	RESET	O
14	GND		32	GND	
15	NC		33	GND	
16	GND		34	GND	
17	TCK	I	35	NC	
18	GND		36	GND	



**Table 5.16 LED Functions**

<b>Part No.</b>	<b>Color</b>	<b>Function Name</b>	<b>Status Indicated When Lit</b>
D1	Green	LNK	Valid link has been made through the LAN interface.
D2	Green	RX	The CPU board is receiving external data through the LAN interface.
D3	Green	TX	The CPU board is sending data through the LAN interface.
D18	Green	Normal	The CPU (SH7751) is in normal operation state.
D19	Green	SLEEP	The CPU (SH7751) is in sleep mode.
D20	Green	STAND-BY	The CPU (SH7751) is in standby mode.
D21	Green	RESET	The CPU (SH7751) is in reset state.
D22	Red	PWR	5.0V, 3.3V, and 1.8V power are all being supplied to the board correctly.

## 5.8 Parts Layout

The parts layout of the CPU board is shown in figure 5.17. The shaded parts are uninstalled. Uninstalled parts are listed in table 5.17.

**Table 5.17 List of Uninstalled Parts**

Part Name	Quantity	Part Number
281E1602-107M	4	C79, C80, C88, C243
269M1602-226M	10	C61, C62, C64, C65, C70, C74, C87, C89, C101, C229
269M1602-335M	4	C68, C72, C429, C430
269M3502-475M	1	C153
GRM39F103Z50	2	C56, C427
GRM39F104Z25	51	C55, C67, C69, C73, C145, C237, C238, C239, C240, C241, C242, C409, C410, C411, C420, C421, C422, C423, C428, C63, C66, C71, C85, C86, C91, C97, C98, C99, C100, C160, C161, C162, C163, C164, C228, C231, C232, C233, C234, C235, C236, C412, C413, C414, C415, C416, C417, C418, C419, C425, C426
GRM39F105Z10	6	C93, C96, C108, C109, C110, C111
GRM40F105Z16	3	C76, C78, C165
GRM39CH150J50	27	C120, C122, C124, C126, C128, C130, C133, C135, C137, C139, C141, C143, C144, C146, C147, C121, C123, C125, C127, C129, C131, C132, C134, C136, C138, C140, C142
GRM39CH181J50	17	C192, C193, C194, C195, C196, C197, C198, C199, C200, C201, C202, C203, C204, C205, C206, C207, C208
GRM39CH220J50	4	C166, C167, C168, C169
GRM39CH221J50	6	C75, C77, C102, C103, C118, C119
GRM39F224Z16	1	C152
GRM39F271J50	2	C94, C95
GRM39F333Z50	1	C90
GRM39F334Z10	2	C106, C107
GRM39CH470J50	4	C148, C149, C150, C151
GRM39F473Z25	1	C92
GRM39CH560J50	6	C112, C113, C114, C115, C116, C117
GRM39CH561J25	2	C104, C105
GRM39F684Z10	2	C83, C84
MCR10EZH-J000	13	R18, R19, R85, R87, R89, R91, R2, R5, R7, R119, R120, R137, R148

**Table 5.17 List of Uninstalled Parts (cont)**

<b>Part Name</b>	<b>Quantity</b>	<b>Part Number</b>
MCR10EZH-J100	1	R26, R83
MCR10EZH-J101	3	R110, R111, R83
MCR10EZH-J102	3	R27, R28, R82
MCR10EZH-J103	9	R71, R72, R37, R77, R78, R79, R94, R131, R132
MCR10EZH-J104	3	R80, R81, R93
MCR10EZH-J105	1	R74
MCR10EZH-J153	4	R86, R88, R90, R92
MCR10EZH-J200	1	R84
MCR10EZH-J220	25	R46, R48, R50, R52, R54, R56, R59, R61, R63, R65, R67, R69, R70, R47, R49, R51, R53, R55, R57, R58, R60, R62, R64, R66, R68
MCR10EZH-J270	2	R44, R45
MCR10EZH-J392	2	R24, R25
MCR10EZH-J432	4	R33, R34, R35, R36
MCR10EZH-J470	1	R73
MCR10EZH-J473	2	R22, R23
MCR10EZH-J512	5	R29, R30, R31, R32, R133
MCR10EZH-J750	6	R38, R39, R40, R41, R42, R43
MNR14-E0AB-J000	3	NR13, NR14, NR68
MNR14-E0AB-103	17	NR11, NR12, NR6, NR7, NR8, NR15, NR16, NR44, NR45, NR46, NR47, NR48, NR49, NR53, NR54, NR55, NR56
MNR14-E0AB-220	3	NR50, NR51, NR52
MNR14-E0AB-221	1	NR10
MNR14-E0AB-472	1	NR9
RJ-6P-103	1	VR1
HSJ1003-01-010	1	CN5
IL-G-2P-S3T2-E	1	CN6
DIC152-8P	1	CN7
IL-G-4P-S3T2-E	1	CN8
D02-M15SAG-13LQ	1	CN9
HIF3F-40PA-2.54DSA	2	CN10, CN11
MH11061-D2	1	CN12
FH10-24S-1SH	1	CN13

**Table 5.17 List of Uninstalled Parts (cont)**

<b>Part Name</b>	<b>Quantity</b>	<b>Part Number</b>
UB1112C-D1	1	CN14
DM11351-Z5-2	1	CN17
53553-1607	1	CN21
DM11351-Z5-3	1	CN22
410-96-202	18	J11, J12, J13, J14, J15, J16, J22, J24, J28, J29, J2A, J2B, J41, J43, J44, J45, J47, J48
310-93-103+310-93-101	2	J31, J32
310-93-103	2	J33, J34
HRF22	8	D4, D5, D6, D7, D8, D9, D10, D11
SML-210MT	4	D13, D14, D15, D16
HSM221C	1	D17
CDRH62B-330	2	L1, L2
LQH3C471	9	L3, L4, L5, L6, L7, L13, L14, L15, L16
BLA62B01	5	L8, L9, L10, L11, L12
SMD150-2	1	F2
LT1031	2	U12, U13
LTC1472	2	U14, U15
TDA1308T	1	U16
NJM386M	1	U17
AD1819AJST	1	U18
HD64465BP	1	U29
HD74LS04FP	1	U30
MQ-200	1	U31
HD6473214F16	1	U33
HD74HC164FP	1	U34
QS3245Q	1	U35
LT1330CG	1	U38
MAX471CSA	1	U39
LT1085CM	1	U50
HD74ALVC16834T-EL	1	U53
CX5F-12.288MHz	1	X1
SG8002CA-12MHz	1	OSC2
SG8002CAPCCB_22MHZ	1	OSC5



## 5.9 Initialization

### 5.9.1 Initializing Resources

Table 5.18 shows which CPU board resources are initialized.

**Table 5.18 Resource Initialization**

Interrupt Resource		Cause of Initialization				Remarks
		Start-up or Power-On Reset Switch Pressed		Manual Reset Switch Pressed		
		Hardware	Monitor Program	Hardware	Monitor Program	
SH7751	CPU	O	—	O	—	
	MMU	O	—	O	—	
	CACHE	O	—	—	—	
	TLB	O	—	—	—	
	CCN	O	—	—	—	
	INTC	O	O	O	O	
	UBC	O	—	—	—	
	CPG	O	O	—	O	
	WDT	O	O	—	O	
	BSC	O	O	—	O	
	DMAC	O	—	O	—	
	TMU	O	—	O	—	
	RTC	O	—	O	—	
	SCI	O	—	O	—	
	SCIF	O	O	O	O	Used by monitor
	PCIC	O	—	O	—	
	I/O PORT	O	—	—	—	
	AUD	—	—	—	—	Initialized by TRST
	H-UDI	—	—	—	—	Initialized by TRST
	ASERAM	—	—	—	—	Initialized by TRST

**Table 5.18 Resource Initialization (cont)**

Interrupt Resource	Cause of Initialization				Remarks
	Start-up or Power-On Reset Switch Pressed		Manual Reset Switch Pressed		
	Hardware	Monitor Program	Hardware	Monitor Program	
Interrupt controller	O	O	O	O	
On-board register	O	O	O	—	
SDRAM (Monitor program work area)	—	O	—	O	
SDRAM (User program area)	—	—	—	—	

Notes: 1. O: Initialized

—: Not initialized

2. When, during HDI and CPU board operation, a power-on reset occurs due to a power supply voltage drop or for other reasons, a "Power on reset is detected." message box is displayed. However, in this case the CPU general registers and control registers are not initialized. Change settings as necessary or restart the HDI.

### 5.9.2 Procedure for Making Initial Settings of the CPU Bus State Controller (BSC)

Figure 5.18 is a flowchart of the procedure for initial settings of the bus state controller (BSC). For information on the settings of each BSC register, please refer to section 5.9.3, Initial Settings of CPU Bus State Controller (BSC).

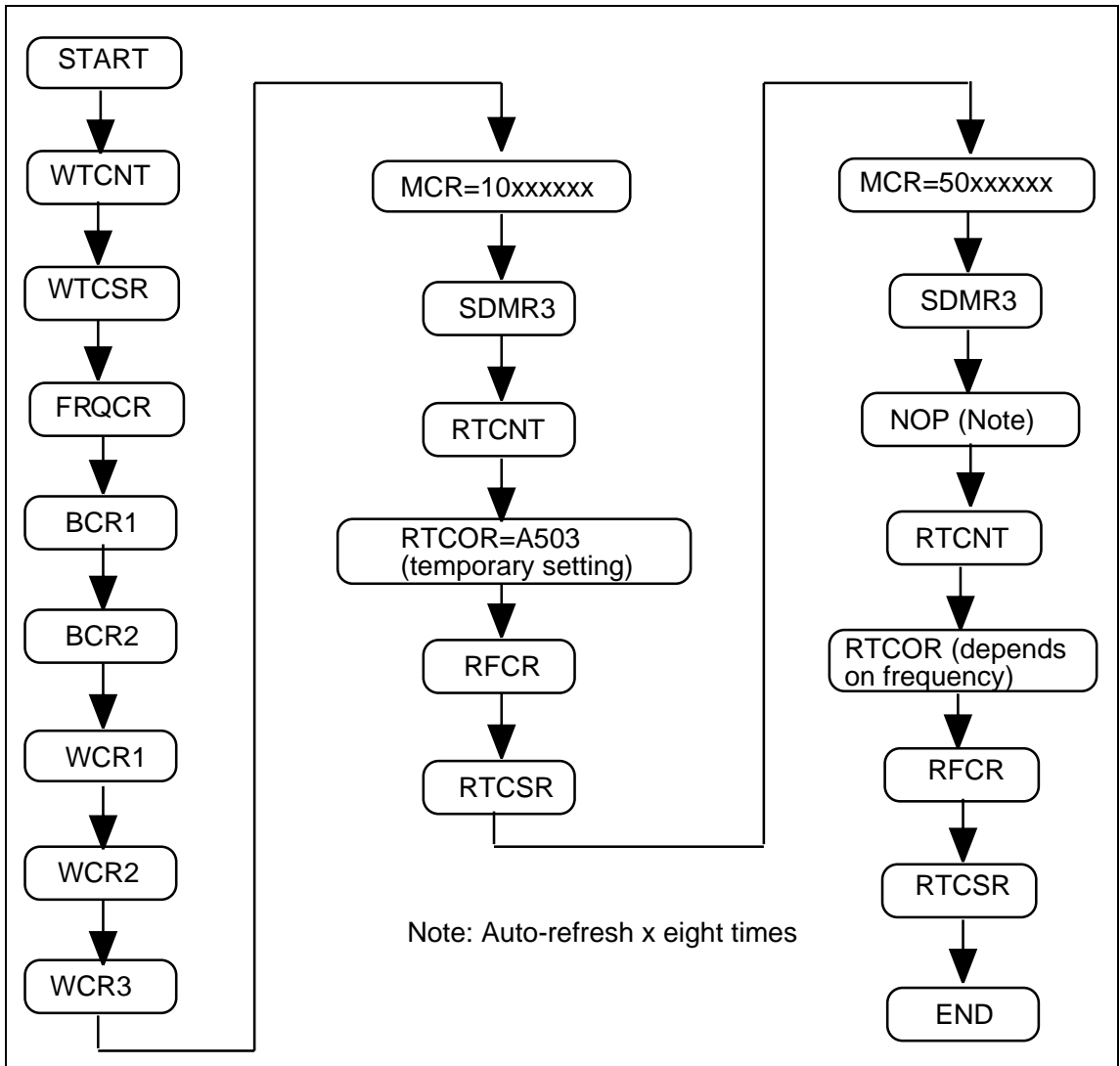

Figure 5.18 Procedure for Setting BSC Settings

### 5.9.3 Initial Settings of CPU Bus State Controller (BSC)

The clock mode is set to 5 in the CPU board. In the bus state controller (BSC) registers, bits corresponding to areas 0, 1 and 3 must not be modified because these areas are assigned to resources of the CPU board. If these bits are modified, the CPU board will not operate. The following shows the initial BSC register values set by the monitor program. In the figures, the shaded bits must not be modified. Separate figures are used to show the register values that depend on the operating frequency (CKIO).

#### Register Values at 83.5 MHz and 55.7 MHz:

- BCR1 (H'FF800000) = H'00080008

Bit No.	31	30	29	28	27	26	25	24	23	22	21	20	19	18	17	16
Bit name	ENDI AN	MAST ER	A0 MPX	-	-	-	DPUP	IPUP	-	-	A1 MBC	A4 MBC	BREQ EN	PSHR	MEM MPX	-
Initial value	0	0	0	0	0	0	0	0	0	0	0	0	1	0	0	0

Bit No.	15	14	13	12	11	10	9	8	7	6	5	4	3	2	1	0
Bit name	HIZ MEM	HIZ CNT	A0 BST2	A0 BST1	A0 BST0	A5 BST2	A5 BST1	A5 BST0	A6 BST2	A6 BST1	A6 BST0	DRA MTP2	DRAM TP1	DRAM TP0	-	A56 PCM
Initial value	0	0	0	0	0	0	0	0	0	0	0	0	1	0	0	0

- BCR2 (H'FF800004) = H' FFF8

Bit No.	15	14	13	12	11	10	9	8	7	6	5	4	3	2	1	0
Bit name	A0 SZ 1	A0 SZ 0	A6 SZ 1	A6 SZ 0	A5 SZ 1	A5 SZ 0	A4 SZ 1	A4 SZ 0	A3 SZ 1	A3 SZ 0	A2 SZ 1	A2 SZ 0	A1 SZ 1	A1 SZ 0	-	PORT EN
Initial value	1	1	1	1	1	1	1	1	1	1	1	1	1	0	0	0

- WCR3 (H'FF800010) = H'07777000

Bit No.	31	30	29	28	27	26	25	24	23	22	21	20	19	18	17	16
Bit name	-	-	-	-	-	A6 S0	A6 H1	A6 H0	-	A5 S0	A5 H1	A5 H0	-	A4 S0	A4 H1	A4 H0
Initial value	0	0	0	0	0	1	1	1	0	1	1	1	0	1	1	1

Bit No.	15	14	13	12	11	10	9	8	7	6	5	4	3	2	1	0
Bit name	-	A3 S0	A3 H1	A3 H0	-	A2 S0	A2 H1	A2 H0	-	A1 S0	A1 H1	A1 H0	-	A0 S0	A0 H1	A0 H0
Initial value	0	1	1	1	0	0	0	0	0	0	0	0	0	0	0	0

- RTCSR (H'FF80001C) = H'A510

Bit No.	15	14	13	12	11	10	9	8	7	6	5	4	3	2	1	0
Bit name	-	-	-	-	-	-	-	-	CMF	CMIE	CKS2	CKS1	CKS0	OVF	OVIE	LMTS
Initial value	1	0	1	0	0	1	0	1	0	0	0	1	0	0	0	0

- RTCNT (H'FF800020) = H'A500

Bit No.	15	14	13	12	11	10	9	8	7	6	5	4	3	2	1	0
Bit name	-	-	-	-	-	-	-	-	-	-	-	-	-	-	-	-
Initial value	1	0	1	0	0	1	0	1	0	0	0	0	0	0	0	0

- RFCR (H'FF800028) = H'A400

Bit No.	15	14	13	12	11	10	9	8	7	6	5	4	3	2	1	0
Bit name	-	-	-	-	-	-	-	-	-	-	-	-	-	-	-	-
Initial value	1	0	1	0	0	1	0	0	0	0	0	0	0	0	0	0

### Register Values at 83.5 MHz:

- FRQCR (H'FFC00000) = H'0E0A

Bit No.	15	14	13	12	11	10	9	8	7	6	5	4	3	2	1	0
Bit name	-	-	-	-	CK OEN	PLL 1EN	PLL 2EN	IFC2	IFC1	IFC0	BFC2	BFC1	BFC0	PFC2	PFC1	PFC0
Initial value	0	0	0	0	1	1	1	0	0	0	0	0	1	0	1	0

- WCR1 (H'FF800008) = H'77771724

Bit No.	31	30	29	28	27	26	25	24	23	22	21	20	19	18	17	16
Bit name	-	DMA IW2	DMA IW1	DMA IW0	-	A6 IW2	A6 IW1	A6 IW0	-	A5 IW2	A5 IW1	A5 IW0	-	A4 IW2	A4 IW1	A4 IW0
Initial value	0	1	1	1	0	1	1	1	0	1	1	1	0	1	1	1

Bit No.	15	14	13	12	11	10	9	8	7	6	5	4	3	2	1	0
Bit name	-	A3 IW2	A3 IW1	A3 IW0	-	A2 IW2	A2 IW1	A2 IW0	-	A1 IW2	A1 IW1	A1 IW0	-	A0 IW2	A0 IW1	A0 IW0
Initial value	0	0	0	1	0	1	1	1	0	0	1	0	0	1	0	0

- WCR2 (H'FF80000C) = H'FFFE4EF7

Bit No.	31	30	29	28	27	26	25	24	23	22	21	20	19	18	17	16
Bit name	A6 W2	A6 W1	A6 W0	A6 B2	A6 B1	A6 B0	A5 W2	A5 W1	A5 W0	A5 B2	A5 B1	A5 B0	A4 W2	A4 W1	A4 W0	-
Initial value	1	1	1	1	1	1	1	1	1	1	1	1	1	1	1	0

Bit No.	15	14	13	12	11	10	9	8	7	6	5	4	3	2	1	0
Bit name	A3 W2	A3 W1	A3 W0	-	A2 W2	A2 W1	A2 W0	A1 W2	A1 W1	A1 W0	A0 W2	A0 W1	A0 W0	A0 B2	A0 B1	A0 B0
Initial value	0	1	0	0	1	1	1	0	1	1	1	1	0	1	1	1

- MCR (H'FF800014) = H'480923F4

Bit No.	31	30	29	28	27	26	25	24	23	22	21	20	19	18	17	16
Bit name	RASD	MR SET	TRC 2	TRC 1	TRC 0	-	-	-	TCAS	-	TPC2	TPC1	TPC0	-	RCD1	RCD0
Initial value	0	1	0	0	1	0	0	0	0	0	0	0	1	0	0	1

Bit No.	15	14	13	12	11	10	9	8	7	6	5	4	3	2	1	0
Bit name	TRWL 2	TRWL 1	TRWL 0	TRAS 2	TRAS 1	TRAS 0	BE	SZ1	SZ0	AMX EXT	AMX 2	AMX 1	AMX 0	RFSH	RMODE	EDO MODE
Initial value	0	0	1	0	0	0	1	1	1	1	1	1	0	1	0	0

- SDMR3 (H'FF940088) = H'00

Bit No.	15	14	13	12	11	10	9	8	7	6	5	4	3	2	1	0
Bit name	-	-	-	-	-	-	-	-	D7	D6	D5	D4	D3	D2	D1	D0
Initial value	-	-	-	-	-	-	-	-	0	0	0	0	0	0	0	0

- RTCOR (H'FF800024) = H'A526

Bit No.	15	14	13	12	11	10	9	8	7	6	5	4	3	2	1	0
Bit name	-	-	-	-	-	-	-	-	-	-	-	-	-	-	-	-
Initial value	1	0	1	0	0	1	0	1	0	0	1	0	0	1	1	0

### Register Values at 55.7 MHz:

- FRQCR (H'FFC00000) = H'0E13

Bit No.	15	14	13	12	11	10	9	8	7	6	5	4	3	2	1	0
Bit name	-	-	-	-	CK OEN	PLL 1EN	PLL 2EN	IFC2	IFC1	IFC0	BFC2	BFC1	BFC0	PFC2	PFC1	PFC0
Initial value	0	0	0	0	1	1	1	0	0	0	0	1	0	0	1	1

• WCR1 (H'FF800008) = H'77771714

Bit No.	31	30	29	28	27	26	25	24	23	22	21	20	19	18	17	16
Bit name	-	DMA IW2	DMA IW1	DMA IW0	-	A6 IW2	A6 IW1	A6 IW0	-	A5 IW2	A5 IW1	A5 IW0	-	A4 IW2	A4 IW1	A4 IW0
Initial value	0	1	1	1	0	1	1	1	0	1	1	1	0	1	1	1

Bit No.	15	14	13	12	11	10	9	8	7	6	5	4	3	2	1	0
Bit name	-	A3 IW2	A3 IW1	A3 IW0	-	A2 IW2	A2 IW1	A2 IW0	-	A1 IW2	A1 IW1	A1 IW0	-	A0 IW2	A0 IW1	A0 IW0
Initial value	0	0	0	1	0	1	1	1	0	0	0	1	0	1	0	0

• WCR2 (H'FF80000C) = H'FFFE4EEF

Bit No.	31	30	29	28	27	26	25	24	23	22	21	20	19	18	17	16
Bit name	A6 W2	A6 W1	A6 W0	A6 B2	A6 B1	A6 B0	A5 W2	A5 W1	A5 W0	A5 B2	A5 B1	A5 B0	A4 W2	A4 W1	A4 W0	-
Initial value	1	1	1	1	1	1	1	1	1	1	1	1	1	1	1	0

Bit No.	15	14	13	12	11	10	9	8	7	6	5	4	3	2	1	0
Bit name	A3 W2	A3 W1	A3 W0	-	A2 W2	A2 W1	A2 W0	A1 W2	A1 W1	A1 W0	A0 W2	A0 W1	A0 W0	A0 B2	A0 B1	A0 B0
Initial value	0	1	0	0	1	1	1	0	1	1	1	0	1	1	1	1

• MCR (H'FF800014) = H'400923F4

Bit No.	31	30	29	28	27	26	25	24	23	22	21	20	19	18	17	16
Bit name	RASD	MR SET	TRC 2	TRC 1	TRC 0	-	-	-	TCAS	-	TPC2	TPC1	TPC0	-	RCD1	RCD0
Initial value	0	1	0	0	0	0	0	0	0	0	0	0	1	0	0	1

Bit No.	15	14	13	12	11	10	9	8	7	6	5	4	3	2	1	0
Bit name	TRWL 2	TRWL 1	TRWL 0	TRAS 2	TRAS 1	TRAS 0	BE	SZ1	SZ0	AMX EXT	AMX 2	AMX 1	AMX 0	RFSH	RMODE	EDO MODE
Initial value	0	0	1	0	0	0	1	1	1	1	1	1	0	1	0	0

- SDMR3 (H'FF940088) = H'00

Bit No.	15	14	13	12	11	10	9	8	7	6	5	4	3	2	1	0
Bit name	-	-	-	-	-	-	-	-	D7	D6	D5	D4	D3	D2	D1	D0
Initial value	-	-	-	-	-	-	-	-	0	0	0	0	0	0	0	0

- RTCOR (H'FF800024) = H'A519

Bit No.	15	14	13	12	11	10	9	8	7	6	5	4	3	2	1	0
Bit name	-	-	-	-	-	-	-	-	-	-	-	-	-	-	-	-
Initial value	1	0	1	0	0	1	0	1	0	0	0	1	1	0	0	1

# Section 6 Notes and Troubleshooting

## 6.1 Notes

### 1. User Program Execution

- (1) When executing a user program, the following interrupts cannot be used. This is because the monitor program is using the following CPU functions for debugging purposes.
  - User Break Controller (UBC)
  - Serial Communication Interface with FIFO (SCIF)
  - TRAPA#255 Trap instruction
- (2) If a single-step execution is performed for an illegal instruction, the program counter will not increment the count; do not perform single-step executions for illegal instructions.
- (3) When a multiple step execution is performed for a program that contains the SLEEP instruction (from the [Step...] menu), the execution speed ([RATE]) must be set to 6 in the Step Program dialog box. Otherwise an error ([Command not ready] error) will occur when the SLEEP instruction is executed, and execution from then on cannot be accepted. In such case, press the abort switch (SW4) and start execution again.
- (4) The abort switch (SW2) input is ORed with the NMI input from the expansion board, then input to the NMI pin in the CPU. Therefore, if the NMI is fixed to low level on the user expansion board, the abort switch will not work.
- (5) During single-step execution, standard C libraries are also executed. To return to a higher-level function, use Step Out. In a for statement or a while statement, executing a single step does not move execution to the next line. To move to the next line, execute two steps.

2. The monitor program uses NMI and SCIF interrupts, so the user can use interrupts of mask level 14 or lower. If an interrupt is set to mask level 15, correct operation cannot be guaranteed. The default mask level is set to 14.

### 3. Interrupt and Exception Display

- (1) The following interrupts and exceptions are displayed on the status bar during user program execution.
  - Address error
  - Illegal general instruction
  - Illegal slot instruction
  - NMI
- (2) When an exception occurs on the CPU board while the user program is not being executed, the HDI will display the EXPEVT code that corresponds to the cause of the exception, and the monitor program will enter the reset-input wait state. In this case, turn the power to the CPU board off and on, or input a reset, and start the HDI to initiate link-up processing.

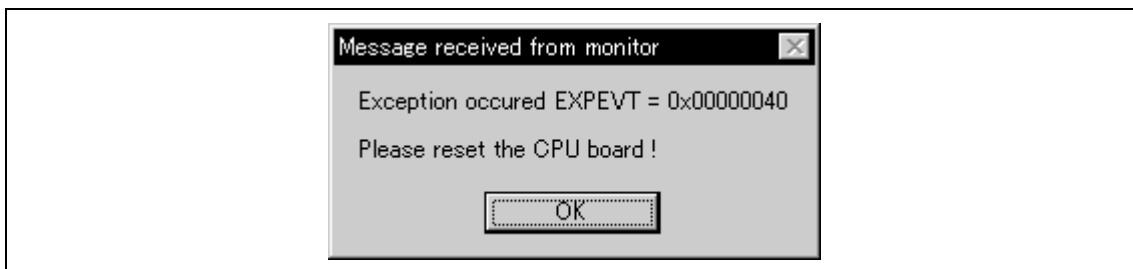

**Figure 6.1 Error Message Displayed at Exception (Instruction TLB Miss Exception)**

#### 4. Breakpoints

- (1) Breakpoints cannot be set in a delay slot of a user program. If an attempt is made to set such a breakpoint, the following message appears.

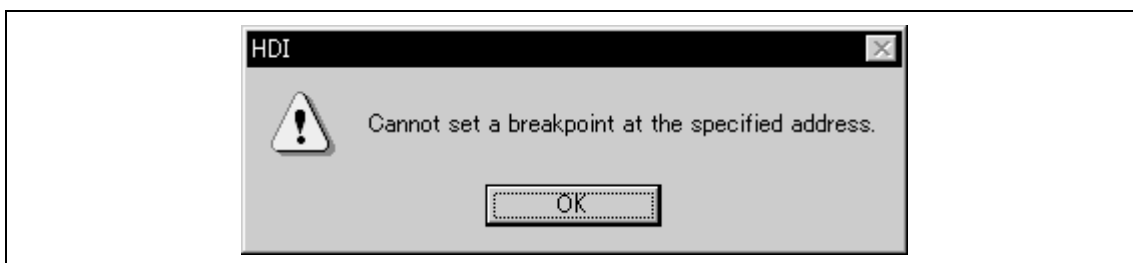

**Figure 6.2 Dialog Box Indicating Breakpoint Cannot Be Set**

For the above reason, a breakpoint may not be set if the initial data in the RAM is invalid when a user program is loaded by specifying a session file. In this case, reload the program by respecifying the session file.

- (2) If a breakpoint is set within an interrupt or exception handler of a user program, it will not cause a break.
- (3) During single-step execution, the settings of the breakpoints are ignored.
- (4) After 255 breakpoints (the maximum number) have been specified, if Add/Edit Breakpoint is selected in the Breakpoints window, an error will occur. In this case, delete any unnecessary breakpoints, and then add or edit breakpoints.
- (5) After setting breakpoints, the CPU board must not be manual reset while the user program is being executed. Otherwise, addresses where breakpoints have been specified will be overwritten with illegal instructions.

To continue debugging the user program, download the user program again.

- (6) A total of 255 breakpoints (including temporary breakpoints) can be set. A temporary breakpoint cannot be set to the same address as an enabled breakpoint.

If a temporary breakpoint is set to the same address as a disabled breakpoint, the breakpoint will be deleted from the breakpoints list after program execution have been completed.

- (7) When the contents of a breakpoint address are modified during user program execution, the breakpoint is disabled. In this case, if user program execution stops by any reason, the modified

contents of the breakpoint address is lost and is replaced with the original contents before user program execution.

- (8) When a breakpoint is set, the block of the data cache that includes the breakpoint address is made invalid when the user program execution starts and after a break occurs.
- (9) When a breakpoint is set, all the entries of the instruction cache is made invalid immediately before user program execution starts and after a break occurs.

5. When a power-on reset or manual reset is input, the dialog box shown in figure. 6.3 and figure. 6.4 respectively is shown.

At this time, general-purpose registers and control registers are not reset. Either settings should be changed as necessary, or the HDI should be restarted. And the run time count function availability also be reset, so must be enabled again by the Run Time Count Condition dialog box if necessary.



**Figure 6.3 Power-on Reset Input Message Box**



**Figure 6.4 Manual Reset Input Message Box**

6. If the power is turned on while pressing and holding the manual reset switch, the CPU board and HDI will not be started. When turning on power, do not operate the manual reset switch.
7. In some cases I/O register values may not be correctly displayed in the memory window. This is because the HDI reads all areas in byte units. In order to display the correct I/O register values, select [I/O Register Window] from the [View] menu.
8. The monitor program sets and uses some of the BSC registers. When rewriting these registers, refer to section 5.9.3, Initial Settings of CPU Bus State Controller (BSC).
9. I/O Ports

Some of the port terminals on this board are also used as pins for other functions, and so some pins cannot be used for port functions. The pin functions that can be used are included as signal names in the pin names of the expansion connector pin assignments in table 5.10 in section 5.4, External Interface. If signal name functions not included in the pin name are used, correct operation is not guaranteed.

#### 10. CPU Operating Mode

The operating mode of this CPU is set at a clock mode 5 and area 0 bus width of 32 bits. For other CPU operating mode setting, only jumper J46 (corresponding to the MD5 signal) can be used to modify the endian.

#### 11. User Expansion Board Interface (User Expansion Area)

##### (1) Areas available for use with the expansion bus

The expansion bus can use areas 2, 4, 5, and 6, and cannot use area 0, 1, or 3. Monitor flash memory is connected to area 0, on-board I/O is connected to area 1, and SDRAM is connected to area 3.

##### (2) Devices which cannot be connected to the expansion bus

DRAM cannot be connected to the expansion bus. (This is because SDRAM on the CPU board is allocated to area 3.)

##### (3) Interrupts

The NMI and external interrupts should all be processed by interrupt handlers in the user program. For details refer to section 7, Creation of User Interrupt Handlers.

#### 12. Refresh Timer

The refresh timer is used as an SDRAM refresh timer, and so cannot be used as an interval timer.

#### 13. SCIF and Host Interface

(1) The serial interface with the host uses the SCIF in the CPU. For this reason, the user cannot use the CPU's internal SCIF except for the standard I/O processing using the [Simulated I/O Window]. For details, refer to section 7.2, User Program Using SCIF. Use SCI instead for a purpose other than standard I/O processing. If the SCIF interface register is accidentally overwritten, the CPU board and HDI will become inoperable.

(2) If the interface is disconnected while a program is being down loaded through the serial interface, the HDI will stop abnormally. In this case, connect the serial interface cable correctly, and start up the CPU board and HDI.

(3) This HDI does not support Motorola S-type files with only the CR code (H'0D) at the end of each record. Load Motorola S-type files with the CR and LF codes (H'0D0A) at the end of each record.

(4) The CPU board and the HDI do not limit the address range for downloading a program. Be sure to download programs to RAM areas. Otherwise operation cannot be guaranteed.

(5) When a Motorola S-type file is down-loaded, two menus, Load Program and Load Memory, can be used, but the Load Program is recommended because it can transfer data faster.

#### 14. Compact PCI Interface

This CPU board is not provided with a PCI driver. When using the compact PCI interface, please provide your own PCI driver.

#### 15. E10A Emulator Interface

If the monitor is used with the E10A emulator connected, correct operation is not guaranteed. Moreover, with the E10A emulator connected the port functions of the Hitachi-UDI and AUD interface signal pins cannot be used.

#### 16. Host Interface Software (HDI)

- (1) In this HDI, the [Command Line] menu can be selected, but operation of the command entered from the command line cannot be guaranteed. Do not use the command line.
- (2) When using this CPU board, always use the included Hitachi Debugging Interface (HDI). If other host interface software is used, the operation of the CPU board and of user programs is not guaranteed.
- (3) User can set default radix value with [Radix] menu from [Setup], but this setting doesn't take effect at line-assemble operation. All input values are assumed as decimal value. Specify H' or 0x as the radix for a hexadecimal input.
- (4) This HDI does not support software breakpoint setting in the [Select Function] dialog box (described in section 10, Selecting Functions, in the Hitachi Debugging Interface User's Manual).
- (5) If the following memory contents are displayed in the [Memory] window, they should be incorrect.
  - Word access from address  $2n + 1$
  - Longword access from address  $4n + 1$ ,  $4n + 2$ , or  $4n + 3$The font size used in the memory window must be 4 or larger. In one window, up to 32768 bytes can be displayed.
- (6) For each Watchdog Timer register, there are two registers, to be used separately, for write and read.

**Table 6.1 Watchdog Timer Register**

Register Name	Usage	Register
WTCSR(W)	Write	Watchdog timer control/status register
WTCNT(W)	Write	Watchdog timer counter
WTCSR(R)	Read	Watchdog timer control/status register
WTCNT(R)	Read	Watchdog timer counter

- (7) Since the CPU board cannot use another HDI, re-install this HDI whenever another previously installed HDI is used.  
If another HDI has been used, initiate this HDI with "Run" as follows, without using the session files.

<Directory path name in which HDI is installed>\hdi /n (RET)  
/n initiates the HDI without loading the recently used session files.

If there is another session file on a different debug platform, the following error message is displayed:

```
invalid target system: <recently used debug platform name>
```

- (8) When another HDI is uninstalled after installation of this HDI, some functions may not work correctly. In this case, re-install this HDI.
- (9) For commands such as [Fill Memory] and [Test Memory], it may take a few minutes to complete command execution. This depends on the size of data specified. Since only 5 seconds is specified for the timeout time in the HDI of the CPU board, the [Command not ready] error may occur. In such cases, the results of the command execution will not be guaranteed; therefore, specify a smaller size and execute the command again.
- (10) The access size and target start and end addresses can be specified in the [Fill Memory] dialog box. If the access size does not match the specified start address, the HDI will treat them as follows:
  - Fill size = end address - start address
  - The fill size is decreased to the nearest integer multiple of the access size.
  - The start address is decreased to the nearest integer multiple of the access size.
  - If the fill size is smaller than the access size, the fill size is increased to the nearest integer multiple of the access size.

After the above processing, the HDI performs the memory-fill operation.

## 17. Watch

### (1) Local variables at optimization

Depending on the generated object code, local variables in a C source file that is compiled with the optimization option enabled will not be displayed correctly. Check the generated object code by displaying the Disassembly window.

If the allocation area of the specified local variable does not exist, the following is displayed.

```
Example:      The variable name is asc.  
asc = ? - target error 2010 (xxxx)
```

### (2) Variable name specification

When a name other than a variable name, such as a symbol name or function name, is specified, no data is displayed.

```
Example:      The function name is main.  
main =
```

### (3) Array display

When the number of array elements exceeds 1000, the number exceeding 1000 will not be displayed.

## 18. Run Time Count Function

- (1) The CPU board uses channel 4 of the internal timer of the SH7751 to implement run time count functions. So, the user program cannot use channel 4 of the timer.
- (2) The run time count function is only valid when user program execution has been started by selecting Go from the Run menu. The run time is not measured during single-step execution.
- (3) The overhead due to run time measurement is about 10  $\mu$ s per execution. For example, the execution time of one NOP instruction measured is about 10  $\mu$ s.

19. The values displayed as Cache Status and MMU Status in the Status window are the values for the last break that occurred during user program execution. Values as updated in the I/O Registers window are not displayed in the Status window.

## 6.2 Troubleshooting

1. On starting the HDI, the "Link up" message does not appear.

Check the following:

- The power-on monitor LED (LED22) on the CPU board should be lit.
- The host computer and CPU board should be properly connected by a serial cable.
- The port settings and transfer rate in the [Monitor Setup] dialog box should be correct.
- The CPU board jumper settings should be correct.

2. "Illegal general instruction" appears on the HDI status bar, and program execution is halted.

This is displayed when a general exception occurs. This message appears when the EXPEVT register value is H'180. It is caused by use of a privileged instruction in user mode, by use of an undefined instruction, or for similar reasons. For further information refer to the SH7751 Hardware Manual.

When a privileged instruction has been used in user mode, please take the following steps.

- In the register window, change the SR (status register) MD bit to 1 (privileged mode).
- Or, execute the [Reset CPU] command on the [Run] menu, and set the register values to the following initial values.

**Table 6.2 Register Initial Value Settings**

Register	Initial Value	Description
PC	H'AC000000	User program area start address
SR	H'600000E0	Privileged mode, mask level 14
R15 (SP)	H'AFF80000	Final address of user program area
VBR	H'A0080000 (big endian) H'A0100000 (little endian)	Monitor VBR (different from actual chip)

3. Step command execution is slow.

When the watch window and I/O register window are open, the data in these windows must be rewritten each time a step is executed, and so execution speed will be reduced. Decrease the sizes of these windows to speed execution.

## Section 7 Creation of User Interrupt Handlers

### 7.1 Creation of User Interrupt Handlers

**Cases where exceptions and interrupts are not used in the user program (no user interrupt handlers are created):**

Set the value of VBR to the initial value (big-endian: H'A0080000, little-endian: H'A0100000). By doing so, step execution, breaks, and other debugging functions can be used when an exception or interrupt occurs.

**Cases where exceptions and interrupts are used in the user program (user interrupt handlers are created):**

Set the value of VBR to the start address of the user interrupt handler. By doing so, execution will branch to the user interrupt handler when an exception or interrupt occurs. Add a routine to branch to the following addresses to the user interrupt handler; this will enable step execution, breaks and other debugging functions when an exception or interrupt occurs.

Table 7.1 lists the branch addresses for different interrupt causes.

**Table 7.1 Interrupt Causes and Branch Addresses for User Interrupt Handlers**

<b>Interrupt Cause</b>	<b>Code</b>	<b>Branch Address (Big-Endian)</b>	<b>Branch Address (Little-Endian)</b>
UBC trap	EXPEVT=1E0	H'A0082000	H'A0102000
Unconditional trap (FF)	EXPEVT=160	H'A0082020	H'A0102020
Reserved instruction code exception	EXPEVT=180	H'A0082040	H'A0102040
Slot illegal instruction exception	EXPEVT=1A0	H'A0082060	H'A0102060
CPU address error (load)	EXPEVT=0E0	H'A0082080	H'A0102080
CPU address error (store)	EXPEVT=100	H'A0082080	H'A0102080
NMI	INTEVT=1C0	H'A00820C0	H'A01020C0
SCIF-RXI*	INTEVT=720	H'A00820E0	H'A01020E0

Note: When the SCIF is not used, a program to branch to the SCI-RXI destination address must be prepared.

Attention should be paid to the following when creating an interrupt handler.

1. When branching to a branch address from the user interrupt handler, the values of R0 and R1 (BANK1) must be saved on the stack.

In other words,            @(R15-8) = R1 at time of exception (BANK1)  
                              @(R15-4) = R0 at time of exception (BANK1)

The following is an example of code which achieves this.

```
MOV.L    R0, @-R15; save R0_BANK1
MOV.L    R1, @-R15; save R1_BANK1
```

By this means, register values can be displayed during debugging when an exception or interrupt occurs.

2. The values of control registers and general-purpose registers other than R0 and R1 should be saved at the time of occurrence of an exception or interrupt.
3. The BL bit of the SR register should be kept as 1 from the occurrence of an exception until branching to the branch address.
4. The values of the SSR, SPC, EXPEVT, INTEVT, and TRA registers should be saved at the time of occurrence of an exception.
5. Branching from a user interrupt handler should be performed with the RB and MD bits of the SR register both set to 1 (the state of occurrence of an exception or interrupt).

## 7.2 User Program Using SCIF

The user program cannot usually access the serial communication interface with FIFO (SCIF) in the SH7751 because the CPU board uses it to communicate with the host PC. The CPU board provides the [Simulated I/O Window] window to allow the user to use the SCIF.

When the SCIF is used from the user program, the SCIF driver in the user program communicates with the [Simulated I/O Window] window on the host PC rather than with the actual SCIF directly. As processing for interrupts of the CPU must be added to the user program, a user interrupt handler must be created according to the directions in section 7.1, Creation of User Interrupt Handlers.

The HDI installer CD-R supplied with the CPU board contains a sample program for the user interrupt handler and SCIF driver. For details on the sample program, refer to section 7.3, Sample Program.

### 7.2.1 Creation of SCIF Driver

Note the following when creating the SCIF driver.

- To receive serial data, an interrupt must be used. Create a SCIF-RXI (receive data full interrupt request) processing routine.
- When the [HALT] button is pressed during serial receiving operation, the HDI sends the HALT code (H'12) to the CPU board. When the HALT code is received, execution must branch to the HALT break processing address in the CPU board.

**Table 7.2 HALT Break Destination Address**

Endian	HALT Break Destination Address
Big endian	H'A00820E0
Little endian	H'A01020E0

- The branch to the HALT break processing is performed in the same interface as the branch to user interrupt handlers. For details, refer to section 7.1, Creation of User Interrupt Handlers.

Notes: 1. The SCIF is used for communication between the CPU board and the host computer. If the user uses the SCIF for a purpose other than the communication with the [Simulated I/O Window] window, correct operation cannot be guaranteed. For such purposes, use the SCI.  
2. If processing that branches execution to the HALT break when the HALT code is received is not prepared, the program cannot be stopped by clicking the [HALT] button in the HDI.

### 7.2.2 SCIF-Related Register Settings

The initial values of the SCIF-related registers are shown below. The shaded bits must not be modified.

#### Serial Communication Interface with FIFO (SCIF):

SCSMR2 (H'FFE80000) = H'0000

Bit	15	14	13	12	11	10	9	8	7	6	5	4	3	2	1	0
	-	-	-	-	-	-	-	-	-	CHR	PE	O/E	STO P	-	CKS 1	CKS 0
Initial value	0	0	0	0	0	0	0	0	0	0	0	0	0	0	0	0

SCFCR2 (H'FFE80018) = H'0008

Bit	15	14	13	12	11	10	9	8	7	6	5	4	3	2	1	0
	-	-	-	-	-	RST RG2	RST RG1	RST RG0	RTR G1	RTR G0	TTR G1	TTR G0	MCE	TFR ST	RFR ST	LOO P
Initial value	0	0	0	0	0	0	0	0	0	0	0	0	1	0	0	0

SCSCR2 (H'FFE80008) = H'0033

Bit	15	14	13	12	11	10	9	8	7	6	5	4	3	2	1	0
	-	-	-	-	-	-	-	-	TIE	RIE	TE	RE	REI E	-	CKE 1	CKE 0
Initial value	0	0	0	0	0	0	0	0	0	0	1	1	0	0	1	1

No restrictions are placed on accesses to the SCBRR2, SCFTDR2, SCFSR2, SCFRDR2, SCFDR2, SCSPTR2, and SCLSR2.

### Interrupt Controller (INTC):

For the interrupts used by the user program, any interrupt level from 0 to 14 can be set, but interrupt level 15 must not be used except for the SCIF.

IPRA (H'FFD00004) = H'0000

Bit	15	14	13	12	11	10	9	8	7	6	5	4	3	2	1	0
	TMU0				TMU1				TMU2				RTC			
Initial value	0	0	0	0	0	0	0	0	0	0	0	0	0	0	0	0

IPRB (H'FFD00008) = H'0000

Bit	15	14	13	12	11	10	9	8	7	6	5	4	3	2	1	0
	WDT				REF				SCI				—	—	—	—
Initial value	0	0	0	0	0	0	0	0	0	0	0	0	0	0	0	0

IPRC (H'FFD0000C) = H'00F0

Bit	15	14	13	12	11	10	9	8	7	6	5	4	3	2	1	0
	GPIO				DMAC				SCIF				H-UDI			
Initial value	0	0	0	0	0	0	0	0	1	1	1	1	0	0	0	0

IPRD (H'FFD00010) = H'0000

Bit	15	14	13	12	11	10	9	8	7	6	5	4	3	2	1	0
	IRL0				IRL1				IRL2				IRL3			
Initial value	0	0	0	0	0	0	0	0	0	0	0	0	0	0	0	0

ICR (H'FFD00000) = Undefined

Bit	15	14	13	12	11	10	9	8	7	6	5	4	3	2	1	0
	NM IL						NM IB	NM IE	IRL M							
Initial value	0/1	0	0	0	0	0	0	0	0	0	0	0	0	0	0	0

No restrictions are placed on accesses to the INTPRI00, INTREQ00, INTMSK00, and INTMSKCLR00.

### 7.3 Sample Program

This section describes how to create user interrupt handlers and the SCIF driver by using sample programs.

The sample program files were created in C language and in SH-series assembly language by the work space of the HEW. This program performs echo-back of the characters input from the [Simulated I/O Window] window, line by line, by using the SCIF. The sample program files, including source and object files, are automatically copied to the Sample directory under the HDI installation directory.

Load the compiled load module (Simio.abs), set the program counter and stack pointer values (PC = H'0C000000, R15 = H'AFF80000), and click the [Go] button to execute the program.



**Figure 7.1 Executing the Sample Program**

Note: The HEW work space supplied by this sample program was created by HEW Version 1.1a (Release 3). The program cannot be opened by a HEW version earlier than 1.1a. For details, refer to the Hitachi Embedded Workshop User's Manual.

## File Configuration:

Table 7.3 shows the files that compose the sample program.

**Table 7.3 Sample Program Files**

File Name	Description
(install directory)\Sample\Simio.hws	HEW work space file
(install directory)\Sample\Simio.hww	HEW HWW file
(install directory)\Sample\Simio\Brkaddr.inc	Branch address definition
(install directory)\Sample\Simio\Env.inc	EXPEVT/INTEVT register definition
(install directory)\Sample\Simio\Intprg.src	Interrupt processing program
(install directory)\Sample\Simio\lodefine.h	SH7751 register definition
(install directory)\Sample\Simio\lodevel.c	SCIF driver program
(install directory)\Sample\Simio>Main.c	Main program
(install directory)\Sample\Simio\Resetprg.src	Start program
(install directory)\Sample\Simio\Serial.h	SCIF relation definition
(install directory)\Sample\Simio\Stacksct.src	Global variable/stack area
(install directory)\Sample\Simio\Vect.inc	Vector definition
(install directory)\Sample\Simio\Vecttbl.src	Vector table area
(install directory)\Sample\Simio\Vhandler.src	Interrupt handler
(install directory)\Sample\Simio\Simio.hwp	HEW HWP file
(install directory)\Sample\Simio\Syntax.txt	Syntax text
(install directory)\Sample\Simio\Big\Simio.abs	ABS file for big endian
(install directory)\Sample\Simio\Little\Simio.abs	ABS file for little endian
(install directory)\Sample\Simio\Make\Big.mak	Make file for big endian
(install directory)\Sample\Simio\Make\Little.mak	Make file for little endian

## Sections:

Table 7.4 shows the sections for the sample program.

**Table 7.4 Sections for the Sample Program**

Address	Section Name
H'0C000000 -	Start, IntPRG, P, and C
H'0CF7F000 -	Dataarea
H'0CF7FC00 - H'0CF7FFFF	Stack
H'AC010000 -	INTHandler and INTTBL

## Interrupt Handlers:

The interrupt sources and their processing are shown in table 7.5. If an interrupt that is not listed in table 7.5 occurs, a sleep instruction will be executed.

**Table 7.5 Interrupt Processing in the Sample Program**

<b>Interrupt Source</b>	<b>Code</b>	<b>Processing</b>
UBC trap	EXPEVT = 1E0	Branches to the CPU board. This processing is used by Step execution.
Unconditional trap (FF)	EXPEVT = 160	Branches to the CPU board. This processing is used by breakpoint function.
Reserved instruction code exception	EXPEVT = 180	Branches to the CPU board and informs the occurrence of a reserved instruction code exception.
Slot illegal instruction exception	EXPEVT = 1A0	Branches to the CPU board and informs the occurrence of a slot illegal instruction exception.
CPU address error (load)	EXPEVT = 0E0	Branches to the CPU board and informs the occurrence of a CPU address error exception.
CPU address error (store)	EXPEVT = 100	Branches to the CPU board and informs the occurrence of a CPU address error exception.
NMI	INTEVT = 1C0	Branches to the CPU board. This processing is used when execution is stopped by using the abort switch.
SCIF-RXI	INTEVT = 720	Buffers the characters received through the SCIF. When the HALT code (H'12) is received, execution branches to the CPU board. This processing is used when execution is stopped by the [HALT] button.

---

## **SH7751 CPU Board HS7751STC01H User's Manual**

Publication Date: 1st Edition, September 2000

Published by: Electronic Devices Sales & Marketing Group  
Semiconductor & Integrated Circuits  
Hitachi, Ltd.

Edited by: Technical Documentation Group  
Hitachi Kodaira Semiconductor Co., Ltd.

Copyright © Hitachi, Ltd., 2000. All rights reserved. Printed in Japan.