

To our customers,

---

## Old Company Name in Catalogs and Other Documents

---

On April 1<sup>st</sup>, 2010, NEC Electronics Corporation merged with Renesas Technology Corporation, and Renesas Electronics Corporation took over all the business of both companies. Therefore, although the old company name remains in this document, it is a valid Renesas Electronics document. We appreciate your understanding.

Renesas Electronics website: <http://www.renesas.com>

April 1<sup>st</sup>, 2010  
Renesas Electronics Corporation

Issued by: Renesas Electronics Corporation (<http://www.renesas.com>)

Send any inquiries to <http://www.renesas.com/inquiry>.

## Notice

1. All information included in this document is current as of the date this document is issued. Such information, however, is subject to change without any prior notice. Before purchasing or using any Renesas Electronics products listed herein, please confirm the latest product information with a Renesas Electronics sales office. Also, please pay regular and careful attention to additional and different information to be disclosed by Renesas Electronics such as that disclosed through our website.
2. Renesas Electronics does not assume any liability for infringement of patents, copyrights, or other intellectual property rights of third parties by or arising from the use of Renesas Electronics products or technical information described in this document. No license, express, implied or otherwise, is granted hereby under any patents, copyrights or other intellectual property rights of Renesas Electronics or others.
3. You should not alter, modify, copy, or otherwise misappropriate any Renesas Electronics product, whether in whole or in part.
4. Descriptions of circuits, software and other related information in this document are provided only to illustrate the operation of semiconductor products and application examples. You are fully responsible for the incorporation of these circuits, software, and information in the design of your equipment. Renesas Electronics assumes no responsibility for any losses incurred by you or third parties arising from the use of these circuits, software, or information.
5. When exporting the products or technology described in this document, you should comply with the applicable export control laws and regulations and follow the procedures required by such laws and regulations. You should not use Renesas Electronics products or the technology described in this document for any purpose relating to military applications or use by the military, including but not limited to the development of weapons of mass destruction. Renesas Electronics products and technology may not be used for or incorporated into any products or systems whose manufacture, use, or sale is prohibited under any applicable domestic or foreign laws or regulations.
6. Renesas Electronics has used reasonable care in preparing the information included in this document, but Renesas Electronics does not warrant that such information is error free. Renesas Electronics assumes no liability whatsoever for any damages incurred by you resulting from errors in or omissions from the information included herein.
7. Renesas Electronics products are classified according to the following three quality grades: "Standard", "High Quality", and "Specific". The recommended applications for each Renesas Electronics product depends on the product's quality grade, as indicated below. You must check the quality grade of each Renesas Electronics product before using it in a particular application. You may not use any Renesas Electronics product for any application categorized as "Specific" without the prior written consent of Renesas Electronics. Further, you may not use any Renesas Electronics product for any application for which it is not intended without the prior written consent of Renesas Electronics. Renesas Electronics shall not be in any way liable for any damages or losses incurred by you or third parties arising from the use of any Renesas Electronics product for an application categorized as "Specific" or for which the product is not intended where you have failed to obtain the prior written consent of Renesas Electronics. The quality grade of each Renesas Electronics product is "Standard" unless otherwise expressly specified in a Renesas Electronics data sheets or data books, etc.

"Standard": Computers; office equipment; communications equipment; test and measurement equipment; audio and visual equipment; home electronic appliances; machine tools; personal electronic equipment; and industrial robots.

"High Quality": Transportation equipment (automobiles, trains, ships, etc.); traffic control systems; anti-disaster systems; anti-crime systems; safety equipment; and medical equipment not specifically designed for life support.

"Specific": Aircraft; aerospace equipment; submersible repeaters; nuclear reactor control systems; medical equipment or systems for life support (e.g. artificial life support devices or systems), surgical implantations, or healthcare intervention (e.g. excision, etc.), and any other applications or purposes that pose a direct threat to human life.

8. You should use the Renesas Electronics products described in this document within the range specified by Renesas Electronics, especially with respect to the maximum rating, operating supply voltage range, movement power voltage range, heat radiation characteristics, installation and other product characteristics. Renesas Electronics shall have no liability for malfunctions or damages arising out of the use of Renesas Electronics products beyond such specified ranges.
9. Although Renesas Electronics endeavors to improve the quality and reliability of its products, semiconductor products have specific characteristics such as the occurrence of failure at a certain rate and malfunctions under certain use conditions. Further, Renesas Electronics products are not subject to radiation resistance design. Please be sure to implement safety measures to guard them against the possibility of physical injury, and injury or damage caused by fire in the event of the failure of a Renesas Electronics product, such as safety design for hardware and software including but not limited to redundancy, fire control and malfunction prevention, appropriate treatment for aging degradation or any other appropriate measures. Because the evaluation of microcomputer software alone is very difficult, please evaluate the safety of the final products or system manufactured by you.
10. Please contact a Renesas Electronics sales office for details as to environmental matters such as the environmental compatibility of each Renesas Electronics product. Please use Renesas Electronics products in compliance with all applicable laws and regulations that regulate the inclusion or use of controlled substances, including without limitation, the EU RoHS Directive. Renesas Electronics assumes no liability for damages or losses occurring as a result of your noncompliance with applicable laws and regulations.
11. This document may not be reproduced or duplicated, in any form, in whole or in part, without prior written consent of Renesas Electronics.
12. Please contact a Renesas Electronics sales office if you have any questions regarding the information contained in this document or Renesas Electronics products, or if you have any other inquiries.

(Note 1) "Renesas Electronics" as used in this document means Renesas Electronics Corporation and also includes its majority-owned subsidiaries.

(Note 2) "Renesas Electronics product(s)" means any product developed or manufactured by or for Renesas Electronics.

To all our customers

---

## **Regarding the change of names mentioned in the document, such as Hitachi Electric and Hitachi XX, to Renesas Technology Corp.**

---

The semiconductor operations of Mitsubishi Electric and Hitachi were transferred to Renesas Technology Corporation on April 1st 2003. These operations include microcomputer, logic, analog and discrete devices, and memory chips other than DRAMs (flash memory, SRAMs etc.) Accordingly, although Hitachi, Hitachi, Ltd., Hitachi Semiconductors, and other Hitachi brand names are mentioned in the document, these names have in fact all been changed to Renesas Technology Corp. Thank you for your understanding. Except for our corporate trademark, logo and corporate statement, no changes whatsoever have been made to the contents of the document, and these changes do not constitute any alteration to the contents of the document itself.

Renesas Technology Home Page: <http://www.renesas.com>

Renesas Technology Corp.  
Customer Support Dept.  
April 1, 2003

## Cautions

Keep safety first in your circuit designs!

1. Renesas Technology Corporation puts the maximum effort into making semiconductor products better and more reliable, but there is always the possibility that trouble may occur with them. Trouble with semiconductors may lead to personal injury, fire or property damage.  
Remember to give due consideration to safety when making your circuit designs, with appropriate measures such as (i) placement of substitutive, auxiliary circuits, (ii) use of nonflammable material or (iii) prevention against any malfunction or mishap.

Notes regarding these materials

1. These materials are intended as a reference to assist our customers in the selection of the Renesas Technology Corporation product best suited to the customer's application; they do not convey any license under any intellectual property rights, or any other rights, belonging to Renesas Technology Corporation or a third party.
2. Renesas Technology Corporation assumes no responsibility for any damage, or infringement of any third-party's rights, originating in the use of any product data, diagrams, charts, programs, algorithms, or circuit application examples contained in these materials.
3. All information contained in these materials, including product data, diagrams, charts, programs and algorithms represents information on products at the time of publication of these materials, and are subject to change by Renesas Technology Corporation without notice due to product improvements or other reasons. It is therefore recommended that customers contact Renesas Technology Corporation or an authorized Renesas Technology Corporation product distributor for the latest product information before purchasing a product listed herein.  
The information described here may contain technical inaccuracies or typographical errors.  
Renesas Technology Corporation assumes no responsibility for any damage, liability, or other loss rising from these inaccuracies or errors.  
Please also pay attention to information published by Renesas Technology Corporation by various means, including the Renesas Technology Corporation Semiconductor home page (<http://www.renesas.com>).
4. When using any or all of the information contained in these materials, including product data, diagrams, charts, programs, and algorithms, please be sure to evaluate all information as a total system before making a final decision on the applicability of the information and products. Renesas Technology Corporation assumes no responsibility for any damage, liability or other loss resulting from the information contained herein.
5. Renesas Technology Corporation semiconductors are not designed or manufactured for use in a device or system that is used under circumstances in which human life is potentially at stake. Please contact Renesas Technology Corporation or an authorized Renesas Technology Corporation product distributor when considering the use of a product contained herein for any specific purposes, such as apparatus or systems for transportation, vehicular, medical, aerospace, nuclear, or undersea repeater use.
6. The prior written approval of Renesas Technology Corporation is necessary to reprint or reproduce in whole or in part these materials.
7. If these products or technologies are subject to the Japanese export control restrictions, they must be exported under a license from the Japanese government and cannot be imported into a country other than the approved destination.  
Any diversion or reexport contrary to the export control laws and regulations of Japan and/or the country of destination is prohibited.
8. Please contact Renesas Technology Corporation for further details on these materials or the products contained therein.

**SH7729R E10A  
Emulation Memory Board  
(HS7729REJH02H)  
User's Manual**

# Cautions

1. Hitachi neither warrants nor grants licenses of any rights of Hitachi's or any third party's patent, copyright, trademark, or other intellectual property rights for information contained in this document. Hitachi bears no responsibility for problems that may arise with third party's rights, including intellectual property rights, in connection with use of the information contained in this document.
2. Products and product specifications may be subject to change without notice. Confirm that you have received the latest product standards or specifications before final design, purchase or use.
3. Hitachi makes every attempt to ensure that its products are of high quality and reliability. However, contact Hitachi's sales office before using the product in an application that demands especially high quality and reliability or where its failure or malfunction may directly threaten human life or cause risk of bodily injury, such as aerospace, aeronautics, nuclear power, combustion control, transportation, traffic, safety equipment or medical equipment for life support.
4. Design your application so that the product is used within the ranges guaranteed by Hitachi particularly for maximum rating, operating supply voltage range, heat radiation characteristics, installation conditions and other characteristics. Hitachi bears no responsibility for failure or damage when used beyond the guaranteed ranges. Even within the guaranteed ranges, consider normally foreseeable failure rates or failure modes in semiconductor devices and employ systemic measures such as fail-safes, so that the equipment incorporating Hitachi product does not cause bodily injury, fire or other consequential damage due to operation of the Hitachi product.
5. This product is not designed to be radiation resistant.
6. No one is permitted to reproduce or duplicate, in any form, the whole or part of this document without written approval from Hitachi.
7. Contact Hitachi's sales office for any questions regarding this document or Hitachi semiconductor products.

# IMPORTANT INFORMATION

## READ FIRST

- **READ** this user's manual before using this emulation memory board.
- **KEEP** the user's manual handy for future reference.

**Do not attempt to use the emulation memory board until you fully understand its mechanism.**

### **Emulation Memory Board:**

Throughout this document, the term "emulation memory board" shall be defined as the following products produced only by Hitachi, Ltd. excluding all subsidiary products.

- Emulation memory board
- Power cables supplied together with this emulation memory board

The user system or a host computer is not included in this definition.

### **Purpose of the Emulation Memory Board:**

This emulation memory board is an optional board for supporting the development of the systems using the SH7729R. This memory board must only be used for the above purpose.

### **Improvement Policy:**

Hitachi, Ltd. (including its subsidiaries, hereafter collectively referred to as Hitachi) pursues a policy of continuing improvement in design, functions, performance, and safety of the emulation memory board. Hitachi reserves the right to change, wholly or partially, the specifications, design, user's manual, and other documentation at any time without notice.

### **Target User of the Emulation Memory Board:**

This emulation memory board should only be used by those who have carefully read and thoroughly understood the information and restrictions contained in the user's manual. Do not attempt to use the emulation memory board until you fully understand its mechanism.

It is highly recommended that first-time users be instructed by users that are well versed in the operation of the emulation memory board.

# **LIMITED WARRANTY**

Hitachi warrants its emulation memory boards to be manufactured in accordance with published specifications and free from defects in material and/or workmanship. Hitachi, at its option, will repair or replace any emulation memory boards returned intact to the factory, transportation charges prepaid, which Hitachi, upon inspection, determine to be defective in material and/or workmanship. The foregoing shall constitute the sole remedy for any breach of Hitachi's warranty. See the Hitachi warranty booklet for details on the warranty period. This warranty extends only to you, the original Purchaser. It is not transferable to anyone who subsequently purchases the emulation memory board from you. Hitachi is not liable for any claim made by a third party or made by you for a third party.

## **DISCLAIMER**

HITACHI MAKES NO WARRANTIES, EITHER EXPRESS OR IMPLIED, ORAL OR WRITTEN, EXCEPT AS PROVIDED HEREIN, INCLUDING WITHOUT LIMITATION THEREOF, WARRANTIES AS TO MARKETABILITY, MERCHANTABILITY, FITNESS FOR ANY PARTICULAR PURPOSE OR USE, OR AGAINST INFRINGEMENT OF ANY PATENT. IN NO EVENT SHALL HITACHI BE LIABLE FOR ANY DIRECT, INCIDENTAL OR CONSEQUENTIAL DAMAGES OF ANY NATURE, OR LOSSES OR EXPENSES RESULTING FROM ANY DEFECTIVE EMULATION MEMORY BOARD, THE USE OF ANY EMULATION MEMORY BOARD, OR ITS DOCUMENTATION, EVEN IF ADVISED OF THE POSSIBILITY OF SUCH DAMAGES. EXCEPT AS EXPRESSLY STATED OTHERWISE IN THIS WARRANTY, THIS EMULATION MEMORY BOARD IS SOLD "AS IS", AND YOU MUST ASSUME ALL RISK FOR THE USE AND RESULTS OBTAINED FROM THE EMULATION MEMORY BOARD.

**State Law:**

Some states do not allow the exclusion or limitation of implied warranties or liability for incidental or consequential damages, so the above limitation or exclusion may not apply to you. This warranty gives you specific legal rights, and you may have other rights which may vary from state to state.

**The Warranty is Void in the Following Cases:**

Hitachi shall have no liability or legal responsibility for any problems caused by misuse, abuse, misapplication, neglect, improper handling, installation, repair or modifications of the emulation memory board without Hitachi's prior written consent or any problems caused by the user system.

**All Rights Reserved:**

This user's manual and emulation memory board are copyrighted and all rights are reserved by Hitachi. No part of this user's manual, all or part, may be reproduced or duplicated in any form, in hard-copy or machine-readable form, by any means available without Hitachi's prior written consent.

**Other Important Things to Keep in Mind:**

1. Circuitry and other examples described herein are meant merely to indicate the characteristics and performance of Hitachi's semiconductor products. Hitachi assumes no responsibility for any intellectual property claims or other problems that may result from applications based on the examples described herein.
2. No license is granted by implication or otherwise under any patents or other rights of any third party or Hitachi.

**Figures:**

Some figures in this user's manual may show items different from your actual system.

**Limited Anticipation of Danger:**

Hitachi cannot anticipate every possible circumstance that might involve a potential hazard. The warnings in this user's manual and on the emulation memory board are therefore not all inclusive. Therefore, you must use the emulation memory board safely at your own risk.

# SAFETY PAGE

## READ FIRST

- **READ** this user's manual before using this emulation memory board.
- **KEEP** the user's manual handy for future reference.

Do not attempt to use the emulation memory board until you fully understand its mechanism.

## DEFINITION OF SIGNAL WORDS



This is the safety alert symbol. It is used to alert you to potential personal injury hazards. Obey all safety messages that follow this symbol to avoid possible injury or death.



**DANGER** indicates an imminently hazardous situation which, if not avoided, will result in death or serious injury.



**WARNING** indicates a potentially hazardous situation which, if not avoided, could result in death or serious injury.



**CAUTION** indicates a potentially hazardous situation which, if not avoided, may result in minor or moderate injury.



**CAUTION** used without the safety alert symbol indicates a potentially hazardous situation which, if not avoided, may result in property damage.

**NOTE** emphasizes essential information.

# **WARNING**

**Observe the precautions listed below. Failure to do so will result in a FIRE HAZARD and will damage the user system, the emulation memory board, and the emulator product or will result in PERSONAL INJURY. The USER PROGRAM will be LOST.**

- 1. Do not repair or remodel the emulation memory board by yourself for electric shock prevention and quality assurance.**
- 2. Always switch OFF the emulator product, the emulation memory board, and the user system before connecting or disconnecting any CABLES or JUMPERS.**
- 3. Always switch OFF the emulation memory board and the user system before connecting or disconnecting the IC socket or the user system interface connector.**
- 4. When connecting the user system interface connector to the IC socket on the user system, ensure that pin 1 on both sides are correctly aligned.**
- 5. Supply power according to the power specifications and do not supply an incorrect power voltage. Use only the provided power cables.**

# Warnings on Emulation Memory Board Usage

Be sure to read and understand the warnings below before using this emulation memory board. Note that these are the main warnings, not a complete list.

## **WARNING**

**Always switch OFF the emulator product, the emulation memory board, and the user system before connecting or disconnecting any CABLES, JUMPERS, or PARTS. Failure to do so will result in a FIRE HAZARD and will damage the emulator product, the emulation memory board, or the user system, or will result in PERSONAL INJURY. The USER PROGRAM will be LOST.**

## **CAUTION**

**Position the emulator product, the emulation memory board, and the user system so that no cable is bent or twisted. A bent or twisted cable will impose stress on the user system interface leading to connection or contact failure. Make sure that the emulation memory board is placed in a secure position so that it does not move during use nor impose stress on the user system interface.**

# Preface

Thank you for purchasing the SH7729R E10A emulation memory board. The emulation memory board supports the development of systems using Hitachi microcomputer SH7729R.

Read this user's manual before using the emulation memory board, and keep the manual handy for future reference.

## **CAUTION**

**READ this user's manual before using the emulation memory board. Incorrect operation or connection will damage the emulation memory board and the user system. The USER PROGRAM will be LOST.**

### **Related Manuals:**

- SH7729R Hardware Manual
- SH7729R E10A Emulator User's Manual

### **Related Hardware:** SH7729R E10A Emulators

- HS7729RKCM01H
- HS7729RKCM02H
- HS7729RKCI01H
- HS7729RKCI02H



# Contents

Section 1	Overview .....	1
1.1	Features .....	1
1.2	Components .....	2
Section 2	Notes on Use .....	5
Section 3	Emulation Memory Board Functions.....	7
3.1	List of Functions .....	7
Section 4	Emulation Memory Board Operation .....	9
4.1	Switch Setting .....	10
4.1.1	Setting of the Switch for Selecting the Power Source (SW3).....	10
4.1.2	Jumper Switch Setting .....	10
4.1.3	DIP Switch (SW2) Setting .....	12
4.1.4	RESET Switch (SW1).....	14
4.2	Monitor LEDs .....	15
Section 5	Connection Procedures .....	17
5.1	Connecting Emulation Memory Board to Emulator and User System .....	17
5.2	Operating Emulation Memory Board Alone (Not Connected to User System).....	23
5.3	Disconnecting Emulation Memory Board from User System.....	25
5.4	Recommended Dimensions for User System Mount Pad .....	26
Section 6	Limitations .....	27
6.1	Unusable Signals.....	27
6.2	Limitations on User System.....	27
Section 7	User System Interface .....	29
7.1	Pin Assignment and Handling of User System Interface Signals .....	29
7.2	Signal Line Handling on the Emulation Memory Board and User System .....	33
Section 8	Emulation Memory Board Block Diagram.....	35
Section 9	Using the Emulator in a Case.....	37



# Section 1 Overview

The SH7729R E10A emulation memory board (hereinafter referred to as the emulation memory board) has an SH7729R (hereafter referred to as the MCU), interface connectors (H-UDI port connectors) for the E10A emulator (hereinafter called the emulator), a user system interface connector, and SRAM devices. User programs can be emulated by connecting this emulation memory board to the emulator.

## 1.1 Features

1. The emulation memory board has emulator connectors and a user system interface connector (YQPACK208SD). When the user system has an IC socket (NQPACK208SD) but has no H-UDI connector, the user system can be connected to the emulator through the emulation memory board and the user program can be emulated.
2. The emulation memory board has SRAM devices that can be used as a substitute for the flash memory or EPROM devices. User programs can be emulated by connecting the emulation memory board to the emulator and supplying power to the emulation board, even when no user system is connected to the emulator.
3. The emulation memory board has jumper switches for various settings. These jumper switches can select
  - (1) the source of the power supplied to the emulation memory board,
  - (2) the source of the clock supplied to the MCU on the emulation memory board, and
  - (3) the destination of the CS0 signal output from the MCU.
4. The emulation memory board has a DIP switch, which can set the MCU's MD terminal status.

## 1.2 Components

Figure 1.1 and table 1.1 show the components of the emulation memory board. Please make sure you have all of these components when unpacking.

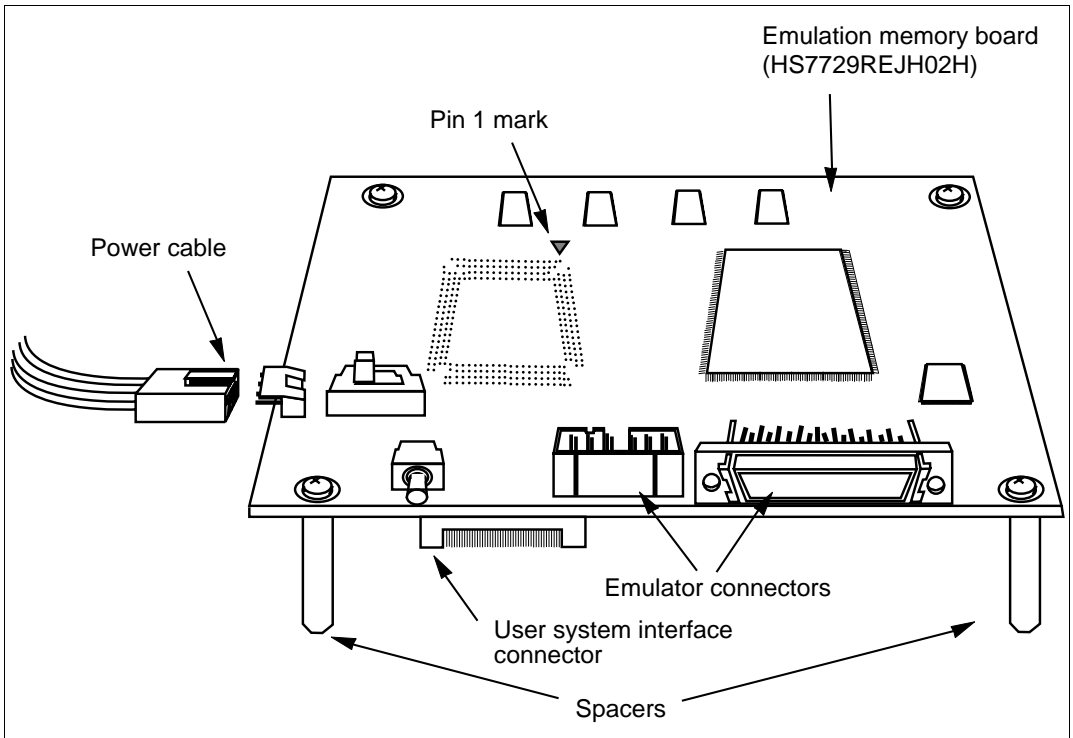

**Figure 1.1 Emulation Memory Board Appearance**

**Table 1.1 Emulation Memory Board Components (HS7729REJH02H)**

<b>Item</b>	<b>Quantity</b>	<b>Notes</b>
Emulation memory board	1	
Power cables (2 cables for 5.0 V and 2 cables for GND)	1 set	For an external power supply
Screws (M2 x 10 mm)	4	For fastening user system interface connector
NQPACK208SD	1	Connector for interfacing with the user system
Guide pins for NQPACK208SD	3	For determining the connector location
Screwdriver	1	For tightening screws
Spacers (13 mm)	4	Fixed to the emulation memory board
SH7729R E10A Emulation Memory Board User's Manual	1	This manual



### **CAUTION**

**READ the following warnings before using the emulation memory board. Incorrect operation will damage the emulation memory board, the user system, and the emulator product. The USER PROGRAM will be LOST.**

1. Cover the emulation memory board with a casing before using it. When using the emulation memory board without a case, do not touch any component and prevent any short circuit.
2. Never place heavy objects on the emulation memory board.
3. Protect the emulation memory board from excessive impacts and stresses.
4. Do not supply power outside the specified voltage range.
5. When moving the emulation memory board, take care not to vibrate or damage it.
6. Supply power to the connected equipment only after connecting all cables. Cables must not be connected or removed while the power is on.
7. The emulation memory board may operate incorrectly due to static electricity. In this case, connect the GND patterns (the spacer-fixed sections at the four corners) on the emulation memory board to those of the user system through cables to discharge static electricity.
8. The emulation memory board can operate only when connected to the emulator; the emulation memory board cannot be used alone or only by connecting to the user system.



# Section 3 Emulation Memory Board Functions

## 3.1 List of Functions

The functions of the emulation memory board are listed in table 3.1.

**Table 3.1 Emulation Memory Board Functions**

Function	Specifications
Clock	<ul style="list-style-type: none"><li>• <math>I\phi</math> (CPU clock): 200 MHz (max.)</li><li>• Clock installed on the emulation memory board: 16.6 MHz (EXTAL input)</li></ul>
Substitution emulation memory	<ul style="list-style-type: none"><li>• Capacity: 4 Mbytes (8 blocks of 256 kwords x 16 bits)</li><li>• 16.6 MHz = <math>B\phi</math> (bus clock): No wait cycle inserted</li><li>• 66 MHz = <math>B\phi</math> (bus clock): Two wait cycles inserted by WCR2</li><li>• Can be allocated to the CS0 area (Substitution memory area: H'00000000 to H'003FFFFFF)</li><li>• Data bus width can be selected from 16 or 32 bits (8-bit width is not supported)</li></ul>
Jumper settings	<ul style="list-style-type: none"><li>• SW3: Selects the power source</li><li>• JP3: Selects the clock source</li><li>• JP4: Selects the CS0 signal output destination</li></ul>
DIP switch settings	<ul style="list-style-type: none"><li>• SW2-1 to SW2-3: Selects the clock operating mode</li><li>• SW2-4 and SW2-5: Selects the memory bus width</li><li>• SW2-6: Selects the endian</li><li>• SW2-7: Specifies the chip mode</li><li>• SW2-8: Specifies the MD0 to MD5 signal input source</li></ul>
RESET switch settings	SW1: Issues a RESET signal
LEDs	<ul style="list-style-type: none"><li>• LED1: RESET and POWER</li><li>• LED2: WAIT and RUN</li><li>• LED3: BREQ and NMI</li><li>• LED4: STATUS1 and STATUS0</li></ul>

**Table 3.1 Emulation Memory Board Functions (cont)**

<b>Function</b>	<b>Specifications</b>
Power supply	<ul style="list-style-type: none"><li>• The emulation memory board can operate alone by supplying +5.0 V through power connector J1 (IL-4P-S3FP2: manufactured by Japan Aviation Electronics Industry, Ltd.) The power connector pins work as follows: Pin 1: GND (black) Pin 2: 5.0 V (red) Pin 3: 5.0 V (red) Pin 4: GND (black)</li><li>• When the emulation memory board is connected to the user system, supply +3.3 V from the VccQ pin on the YQPACK208SD connector.</li></ul>

**Note:** For the substitution emulation memory, a 16-bit bus and a 32-bit bus are supported. Do not set the bus width to 8 bits when using the substitution emulation memory.

## **CAUTION**

### **Restriction on Buffer Control Using the RD Signal:**

**RD signal output cannot be disabled from the emulator. Consequently, when the buffer control on the user system uses only the RD signal, data read from this emulation memory board and data output from the buffer may conflict. For this reason, when using the emulation memory board, be sure to control the data bus buffer of the user system with both the CS and RD (used in direction control) signals.**

# Section 4 Emulation Memory Board Operation

The emulation memory board has a RESET switch (SW1) for issuing a reset signal, a DIP switch (SW2), a switch (SW3) for selecting the power source, and jumper switches (JP3 to JP4) for various settings, and LEDs (LED1 to LED4) for signal monitoring. Figure 4.1 shows the switches and LEDs.

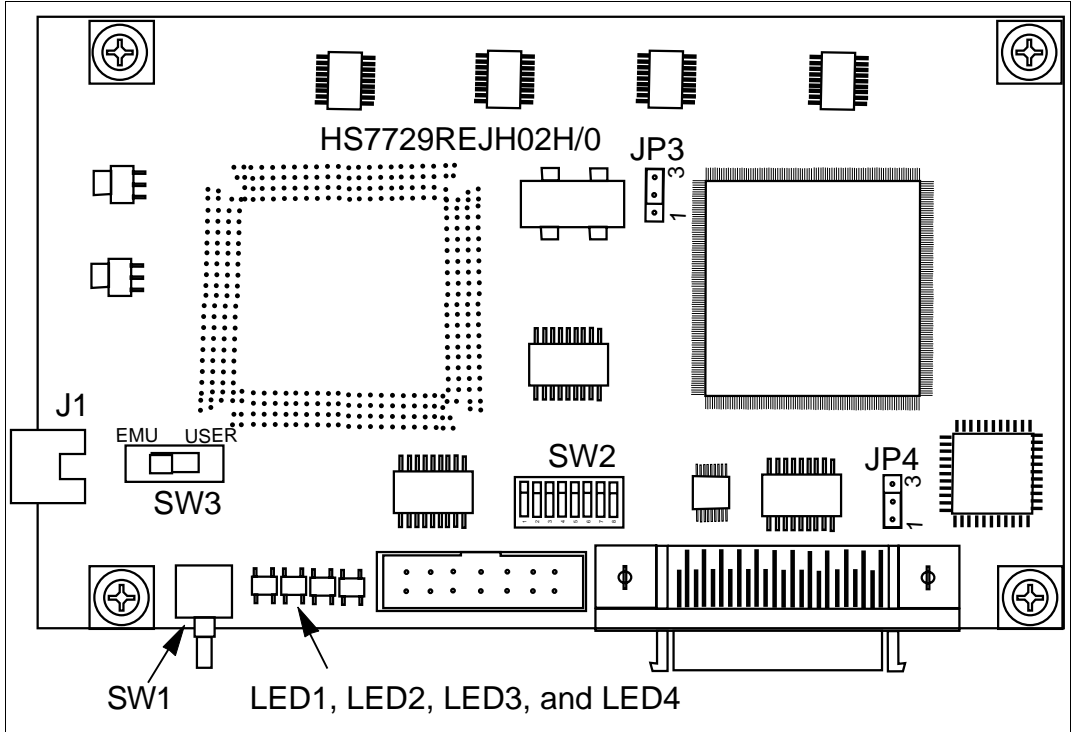

Figure 4.1 Switches and LEDs

## 4.1 Switch Setting

### 4.1.1 Setting of the Switch for Selecting the Power Source (SW3)

SW3 selects whether the power for the emulation memory board is supplied from an external source or through the user system interface.

# WARNING

**Always switch OFF the user system and the emulation memory board before setting the switch (SW3) for selecting the power source. Failure to do so will result in a FIRE HAZARD and will damage the user system and the emulation memory board.**

To supply power from an external source (shifted to EMU\_VCC):



To supply power through the user system interface (shifted to USER\_VCC):

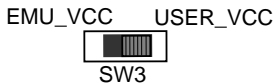

### 4.1.2 Jumper Switch Setting

The emulation memory board has two jumper switches JP3 and JP4 for the following various settings.

**JP3 Function:** The JP3 selects whether the clock for the MCU is supplied from the emulation memory board or from the user system.

To supply the clock from the emulation memory board:

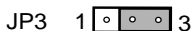

To supply the clock from the user system:

JP3 1  3

**Note:** On the emulation memory board, the clock can be input only through the EXTAL pin. Therefore, be sure to supply the clock to the EXTAL pin when using the user system clock. If the clock is supplied to the XTAL, EXTAL2, or XTAL2 pin, the emulation memory board cannot operate.

**JP4 Function:** The JP4 selects the CS0 signal output destination to specify whether the substitution memory on the emulation memory board or the memory of the user system is used.

## CAUTION

### 1. Restriction on Buffer Control Using the RD Signal:

RD signal output cannot be disabled from the emulator. Consequently, when the buffer control on the user system uses only the RD signal, data read from this emulation memory board and data output from the buffer may conflict. For this reason, when using the emulation memory board, be sure to control the data bus buffer of the user system with both the CS and RD (used in direction control) signals.

2. The substitution emulation memory is allocated to the 4 Mbytes from the start address of area 0. If the memory of the user system is allocated to area 0, that is, the same area as the substitution emulation memory, only the memory selected by the JP4 setting is used. When the substitution emulation memory is selected by JP4, the CS0 signal is not output to the user system.

To use the substitution memory on the emulation memory board:

JP4 1  3

To use the memory of the user system:

JP4 1  3

### 4.1.3 DIP Switch (SW2) Setting

The emulation memory board has one DIP switch for the following settings.

- Selecting the clock operating mode: Three switches
- Selecting the memory bus width: Two switches
- Selecting the endian: One switch
- Selecting the chip mode: One switch
- Selecting the SELECT (MD0 to MD5 input source) : One switch

The methods of setting are shown in tables 4.1 to 4.5.

**Note:** For details on the mode control terminals (MD0 to MD5) and chip mode select terminal (ASEMD0), refer to the SH7729R Hardware Manual.

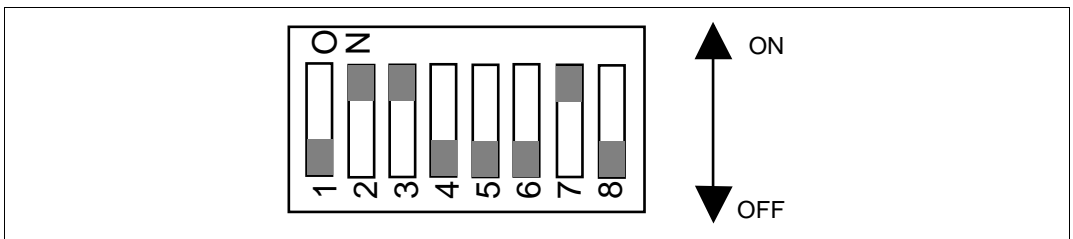

**Figure 4.2 DIP Switch (SW2) Appearance and Settings at Shipment**

**Clock Operating Mode Setting:** Select the clock operating mode as shown in table 4.1.

**Table 4.1 Clock Operating Mode Setting (Switches 1 to 3 in SW2)**

**Switches in SW2 (Corresponding Mode Pins)**

1 (MD0)	2 (MD1)	3 (MD2)	Clock Mode	Remarks
ON	ON	ON	0	
OFF	ON	ON	1	Initial setting at shipment
ON	OFF	ON	2	Not supported* <sup>1</sup>
OFF	OFF	OFF	7* <sup>3</sup>	Not supported when the user system is not connected* <sup>2</sup>

**Notes:** 1. The emulation memory board does not support clock mode 2.

2. Clock mode 7 is valid only when the user system is connected to the emulation memory board and the clock is input to the CKIO pin.

3. When using clock mode 7, select the clock supplied from the user system by setting jumper JP3.

**Memory Bus Width Setting:** Select the memory bus width for area 0 as shown in table 4.2.

**Table 4.2 Memory Bus Width Setting (Switches 4 and 5 in SW2)**

**Switches in SW2**

**(Corresponding Mode Pins)**

<b>4 (MD3)</b>	<b>5 (MD4)</b>	<b>Memory Bus Width</b>	<b>Remarks</b>
ON	ON	Reserved	Do not use this setting
OFF	ON	8 bits	Do not use this setting
ON	OFF	16 bits	
OFF	OFF	32 bits	Initial setting at shipment

**Note:** The substitution emulation memory does not support the 8-bit bus width.

**Endian Setting:** Select the endian as shown in table 4.3.

**Table 4.3 Endian Setting (Switch 6 in SW2)**

**Switch in SW2**

**(Corresponding Mode Pin)**

<b>6 (MD5)</b>	<b>Endian</b>	<b>Remarks</b>
ON	Big endian	
OFF	Little endian	Initial setting at shipment

**Chip Mode Setting:** Set the chip mode to select the pin status as shown in table 4.4.

**Table 4.4 Chip Mode Setting (Switch 7 in SW2)**

**Switch in SW2**

**(Corresponding Pin)**

<b>7 (ASEMD0)</b>	<b>Chip Mode</b>	<b>Remarks</b>
ON	ASE mode	Use this setting when the emulator is connected to the emulation memory board: Initial setting at shipment
OFF	Normal mode	Use this setting when the emulator is not connected

**Note:** The emulation memory board must be connected to the emulator. Use the initial setting at shipment and do not change it.

**SELECT (MD0 to MD5 Input Source) Setting:** Select the source of the signals input to the MD control pins (MD0 to MD5) as shown in table 4.5.

**Table 4.5 SELECT Setting (Switch 8 in SW2)**

**Switch in SW2  
(Corresponding Pin)**

<b>8 (SELECT)</b>	<b>MD0 to MD5 Input Source</b>	<b>Remarks</b>
ON	User system	
OFF	DIP switch settings	Initial setting at shipment

**Note:** When using the emulation memory board without connecting the user system, set the switch OFF.

#### 4.1.4 RESET Switch (SW1)

The emulation memory board has RESET switch for issuing a reset signal.

The /RESETP signal to the MCU is obtained by ORing the reset signal from the RESET switch, that from the power-on reset circuit on the emulation memory board, and the /RESETP signal from the user system interface. The manual reset, on the other hand, is done using only the /RESETM signal from the user system interface. Figure 4.3 shows the logic diagram for the reset circuit.

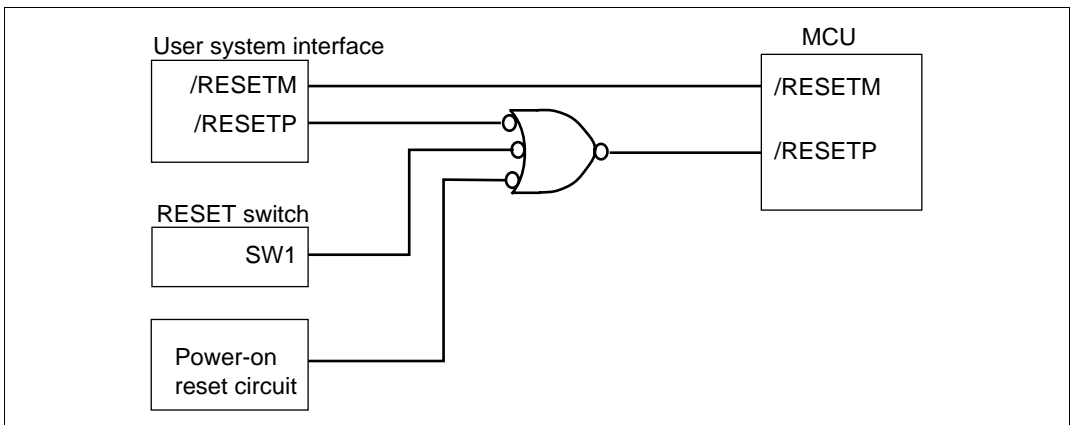

**Figure 4.3 Reset Circuit Logic Diagram**

## 4.2 Monitor LEDs

The emulation memory board has LEDs for monitoring the operating state. Table 4.6 shows the LEDs and the states to be monitored.

For details on STATUS1 and STATUS0 signals, refer to the SH7729R Hardware Manual.

**Table 4.6 LEDs and States to Be Monitored**

LED	Indication on the Board	LED Status	Remarks
LED1	RESET	Lit when /RESETP is asserted	
	POWER	Lit when power is supplied	
LED2	WAIT	Lit when /WAIT is asserted	
	RUN	Turned off in USER RUN state	Signal: ASEBRKAK
LED3	BREQ	Lit when /BREQ is asserted	
	NMI	Lit when /NMI is asserted	
LED4	STATUS1	Lit when STATUS1 is 0 (low)	See the note below
	STATUS0	Lit when STATUS0 is 0 (low)	See the note below

Note: The STATUS1 and STATUS0 are multiplexed with PTJ6 and PTJ7, respectively; when the terminals are used for PTJ6 and PTJ7 signals, the LED4 status is undetermined.

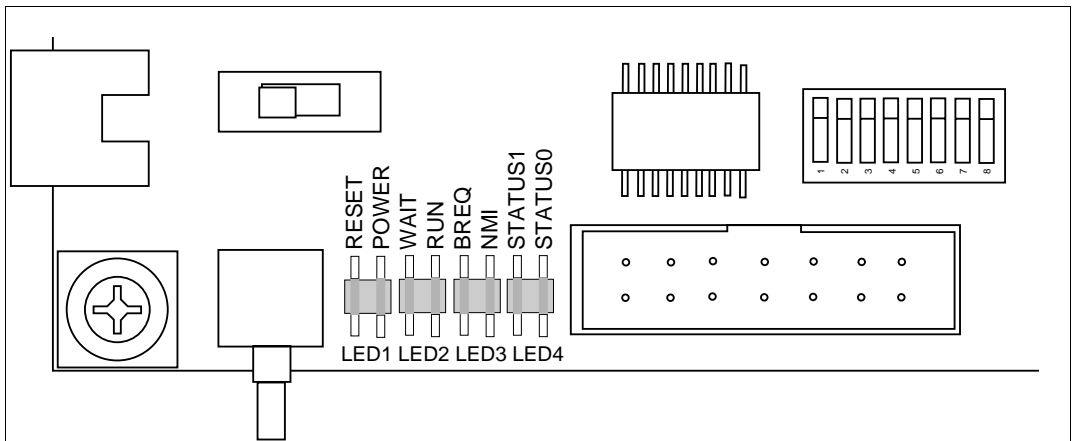

**Figure 4.4 LED Location and Indication on the Board**



## Section 5 Connection Procedures

### 5.1 Connecting Emulation Memory Board to Emulator and User System

Be sure to switch off the emulator and user system before connecting the emulation memory board, emulator, and user system. Do not supply power to the power connector on the emulation memory board when using the user system.

#### **WARNING**

**Observe the precautions listed below. Failure to do so will result in a FIRE HAZARD and will damage the user system, the emulation memory board, and the emulator product or will result in PERSONAL INJURY. The USER PROGRAM will be LOST.**

- 1. Always switch OFF the emulator product, the emulation memory board, and the user system before connecting the EMULATOR PRODUCT, EMULATION MEMORY BOARD, or USER SYSTEM.**
- 2. DO NOT supply power to the emulation memory board power connector (J1) when the emulation memory board is connected to the user system. When connected to the user system, the emulation memory board receives power from the VccQ pin of the IC socket (NQPAC208SD) and operates by the user system power.**

**Connecting Emulation Memory Board to Emulator:** Connect the emulator to the 14-pin connector (CN1) or 36-pin connector (CN2) on the emulation memory board, depending on the emulator type as follows:

HS7729RKCM01H or HS7729RKCI01H: 14-pin connector (CN1)

HS7729RKCM02H or HS7729RKCI02H: 36-pin connector (CN2)

For details on the connection procedure, refer to the SH7729R E10A Emulator User's Manual.

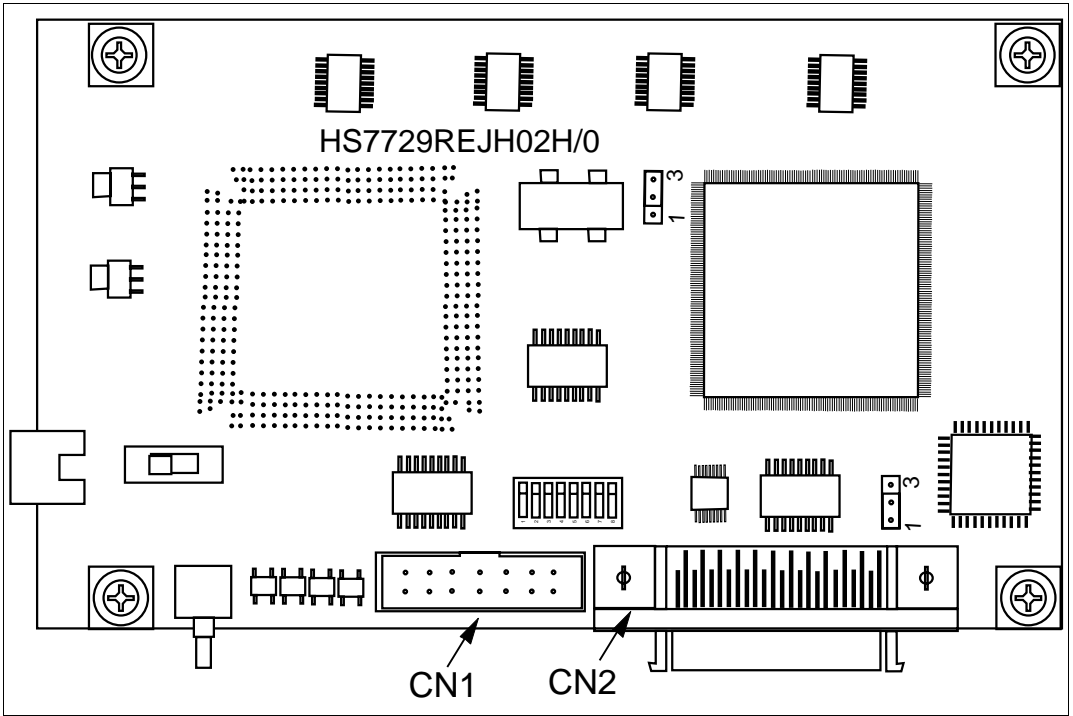

**Figure 5.1 Connectors for the Emulator**

## **WARNING**

**Observe the precautions listed below. Failure to do so will result in a FIRE HAZARD and will damage the user system, the emulation memory board, and the emulator product or will result in PERSONAL INJURY. The USER PROGRAM will be LOST.**

- 1. Always switch OFF the emulator product, the emulation memory board, and the user system before connecting the EMULATOR PRODUCT, EMULATION MEMORY BOARD, or USER SYSTEM.**
- 2. Use the recommended IC socket on the user system. Otherwise, excessive force will be applied to the emulation memory board and the user system when the emulation memory board is connected to or disconnected from the user system.**

## **CAUTION**

- 1. Use NQPACK208SD (manufactured by Tokyo Eletech Corporation) as the LQFP208 IC socket on the user system.**
- 2. To mount the MCU directly on the NQPACK208SD socket, a socket cover must be used. Separately purchase HQPACK208SD (manufactured by Tokyo Eletech Corporation).**

1. Confirm that the pins of the YQPACK connector on the emulation memory board are not bent.
2. Align pin 1 of the YQPACK connector on the emulation memory board with pin 1 of the NQPACK socket on the user system, and insert the connector into the socket.

## **CAUTION**

**The structures of the YQPACK connector and NQPACK socket prevent the connector from being fully inserted in the wrong direction. If the connector cannot be inserted fully, pin 1 on the connector and that on the socket may not be aligned correctly. Check the pin 1 locations on the connector and socket and re-insert the YQPACK connector.**

3. After inserting the YQPACK connector on the emulation memory board into the NQPACK socket of the user system, fix the emulation memory board in place with the supplied screws, as shown in figure 5.2.

## **CAUTION**

1. **Use the supplied screwdriver.**
2. **The tightening torque must be 0.054 N•m or less. Stop tightening when the force required to turn the screw becomes significantly greater than that needed when first tightening.**
3. **If a screw is tightened too much, the screw head may break or an IC socket contact error may be caused by a crack in the IC socket solder.**
4. **If the emulator does not operate correctly, cracks might have occurred in the solder. Check conduction with a tester and re-solder the IC socket if necessary.**

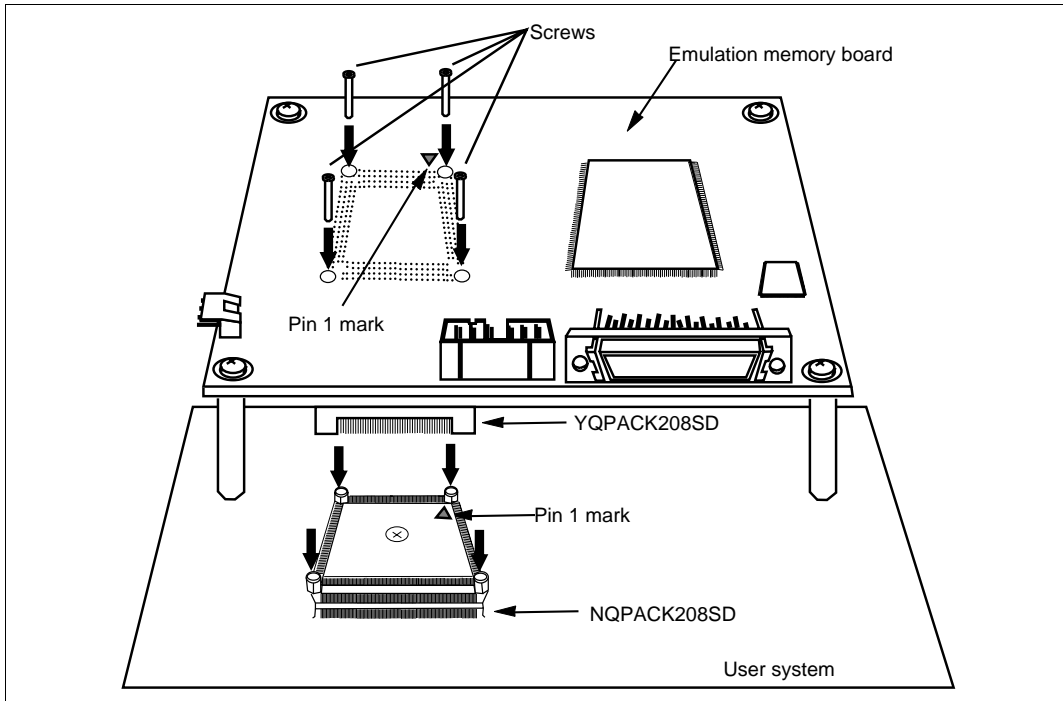

**Figure 5.2 Connecting Emulation Memory Board to User System**

**Power Supply Specifications:** When the user system is connected, the emulation memory board operates by the user system power. Supply the user system power according to the specifications and rising timing shown in table 5.1 and figure 5.3.

## CAUTION

1. Check that the SW3 switch is set to the power supply through the user interface, and supply 3.3-V power to the VccQ pin. DO NOT supply power to the emulation memory board power connector (J1).
2. In the emulation memory board, only 3.3-V power is supplied from the user side while 2.0-V power is generated on the emulation memory board when the user interface (YQPACK) is selected as the power source. Thus the Vcc pin (2.0 V) of the user interface (YQPACK) in the emulation memory board is left unconnected.

Table 5.1 Power Supply Specifications

Allowable Power Range	Current Consumption
+ 3.3 VDC $\pm$ 5%	1420 mA (max.)

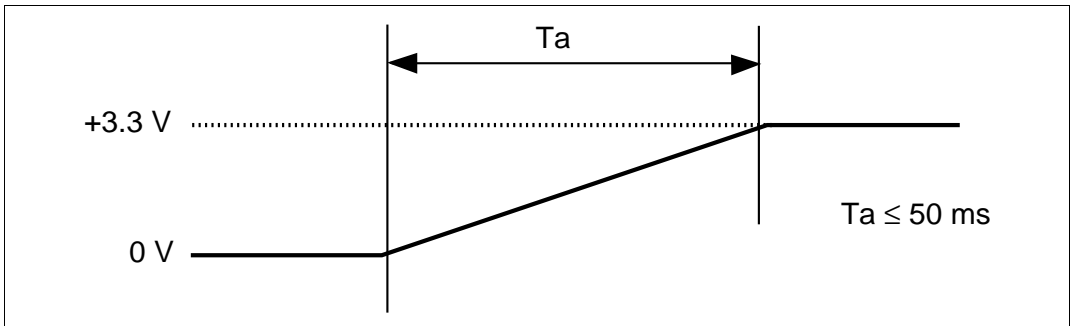

Figure 5.3 Characteristics of DC Rising Timing

## 5.2 Operating Emulation Memory Board Alone (Not Connected to User System)

Be sure to switch off the emulator and emulation memory board before connecting them together and before connecting the power cables to the emulation memory board.

### **WARNING**

**Always switch OFF the emulator product and the emulation memory board before connecting the EMULATOR PRODUCT, EMULATION MEMORY BOARD, or POWER CABLES. Failure to do so will result in a FIRE HAZARD and will damage the emulator product and the emulation memory board or will result in PERSONAL INJURY. The USER PROGRAM will be LOST.**

**Connecting to the Emulator:** Connect the emulation memory board to the emulator by using the same procedure as in section 5.1, Connecting Emulation Memory Board to Emulator and User System.

**Connecting the Power Cables:** After making sure the alignment is correct, connect the provided power cables to the power connector (J1) on the emulation memory board to supply power, as shown in figure 5.4. (The power cable and connector structures will prevent the power cables from being connected in the wrong direction.)

Note that the red cables are for 5.0-V power and the black ones are for GND; connect them to the DC power source correctly. Also see figure 5.4.

### **WARNING**

**Be sure to connect the power cables to the DC power source correctly, that is, the red cables to the 5.0-V power and the black ones to GND. Failure to do so will result in a FIRE HAZARD and will damage the emulator product and the emulation memory board or will result in PERSONAL INJURY. The USER PROGRAM will be LOST.**

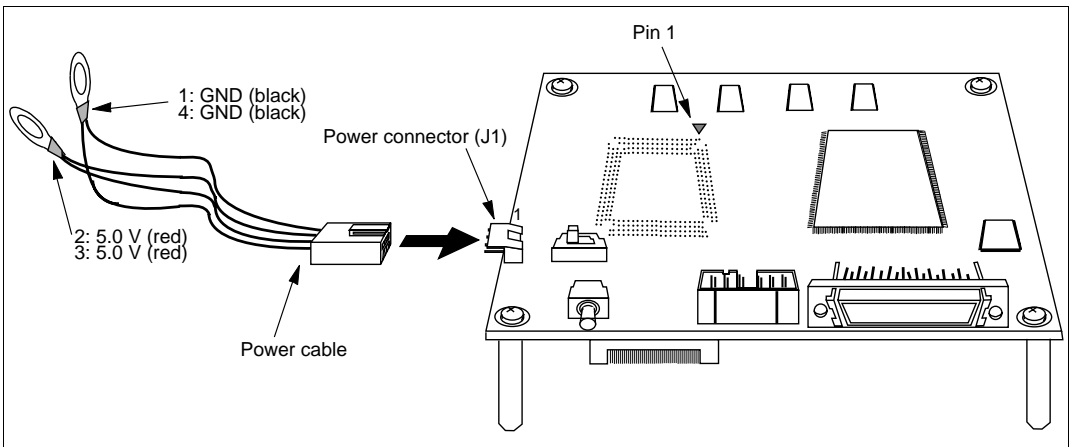
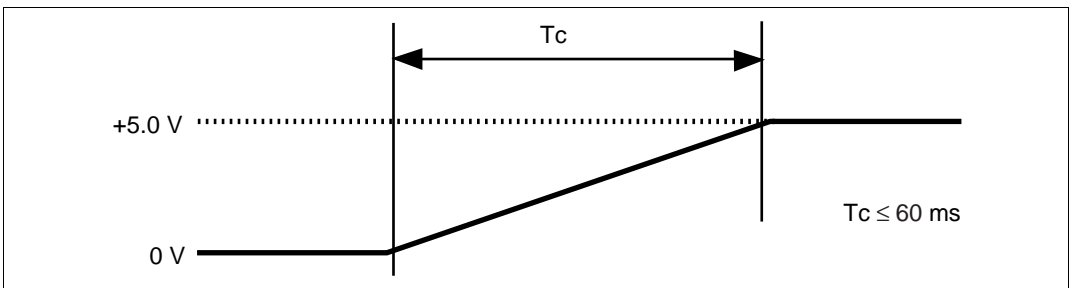

**Figure 5.4 Connecting Power Cables to Power Connector**

**Power Supply Specifications:** Table 5.2 shows the power supply specifications, and figure 5.5 shows the rising timing of the power.

**Table 5.2 Power Supply Specifications**

Allowable Power Range	Current Consumption
+5.0 VDC $\pm$ 5%	1420 mA (max.)



**Figure 5.5 Characteristics of DC Rising Timing**

## 5.3 Disconnecting Emulation Memory Board from User System

Be sure to switch off the emulator and user system before disconnection.

### WARNING

**Always switch OFF the emulator product, the emulation memory board, and the user system before disconnecting the EMULATOR PRODUCT, EMULATION MEMORY BOARD, or USER SYSTEM. Failure to do so will result in a FIRE HAZARD and will damage the emulator product, the emulation memory board, and the user system or will result in PERSONAL INJURY. The USER PROGRAM will be LOST.**

**Disconnecting Emulation Memory Board from User System:** Follow the instructions below.

1. Remove the screws that connect the YQPACK connector and the NQPACK socket.
2. After removing all screws, remove the emulation memory board from the user system, taking care not to bend any of the pins.

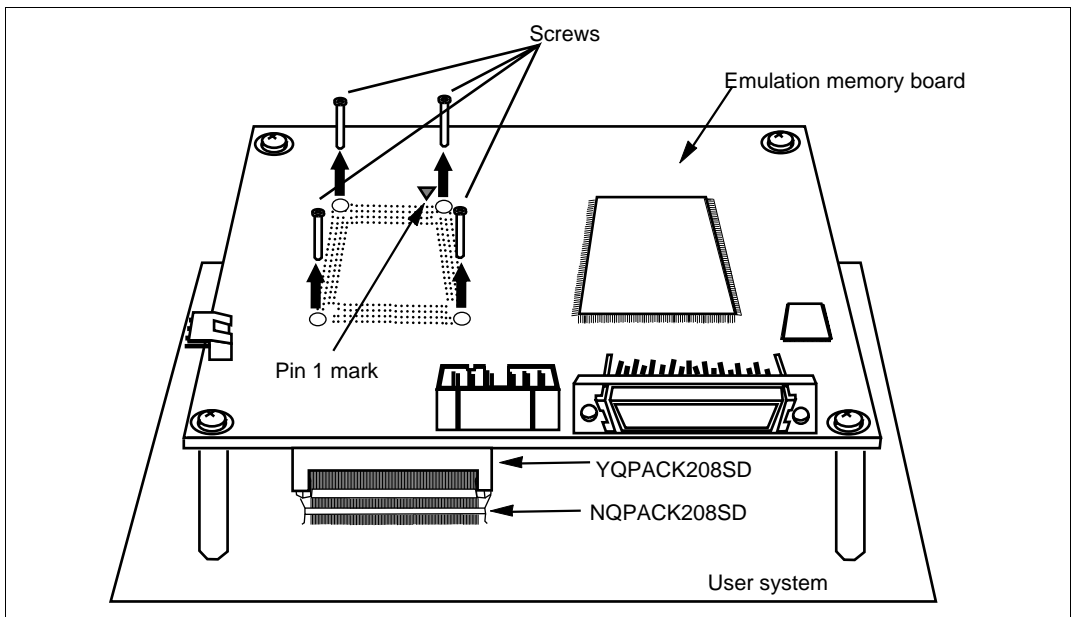

**Figure 5.6 Disconnecting Emulation Memory Board**



# Section 6 Limitations

## 6.1 Unusable Signals

The emulation memory board uses the H-UDI functions. Therefore, the following signals, which are multiplexed with H-UDI signals, cannot be used.

**When the 36-pin Interface (CN2) is Used:** PTE[0], PTE[7], PTF[4:7]/PINT[12:15], PTG[0:3], PTG[5:6], and PTH[6]

**When the 14-pin Interface (CN1) is Used:** PTE[0], PTF[4:7]/PINT[12:15], and PTG[5:6]

**Note:** When the 14-pin interface (CN1) is used as the interface with the emulator, the PTE[7], PTG[0:3], and PTH[6] signals can be used, but to avoid adverse effects from the user system, leave these signals unconnected or pull up these signals on the user system.

## 6.2 Limitations on User System

To use the emulation memory board together with the user system, do not mount any components in the mount-prohibited areas (figure 6.1) of the user system. If any component is mounted on any of these areas, remove the corresponding spacer from the emulation memory board. In this case, take special care not to give any stress to the user system interface section (NQPACK).

The height of the mounted components must be 9.0 mm or shorter in the height-limited area (figure 6.1) of the user system. If any component in this area is higher than 9.0 mm, the emulation memory board cannot be connected to the user system.

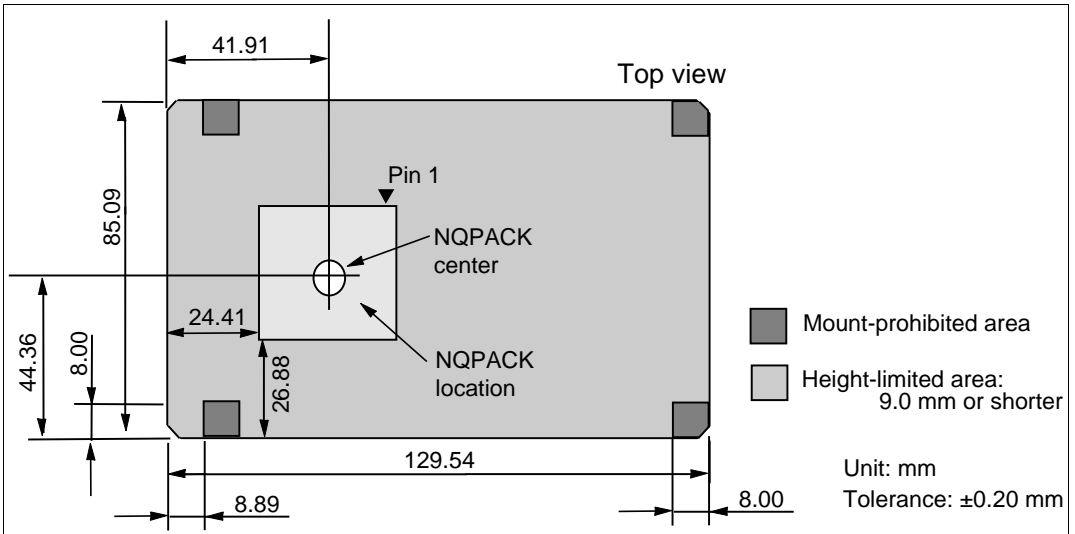

**Figure 6.1 Mount-Prohibited and Height-Limited Areas of User System**

# Section 7 User System Interface

## 7.1 Pin Assignment and Handling of User System Interface Signals

The emulation memory board has a connector (YQPACK) for user system interface. Table 7.1 shows the pin assignment of the user system interface connector and signal handling on the emulation memory board.

**Table 7.1 Pin Assignment and Handling of User System Interface**

No.	Signal Name	Handling	Notes	No.	Signal Name	Handling	Notes
1	MD1	Pull-up	47 kΩ	31	D17/PTA1		
2	MD2	Pull-up	47 kΩ	32	D16/PTA0		
3	Vcc(RTC oscillator)	NC		33	Vss	GND	
4	XTAL2	NC		34	D15		
5	EXTAL2	NC		35	VccQ	3.3 V	
6	Vss(RTC oscillator)	GND		36	D14		
7	NMI	Pull-up	47 kΩ	37	D13		
8	IRL0/IRQ0#/PTH0	Pull-up	47 kΩ	38	D12		
9	IRL1/IRQ1#/PTH1	Pull-up	47 kΩ	39	D11		
10	IRL2/IRQ2#/PTH2	Pull-up	47 kΩ	40	D10		
11	IRL3/IRQ3#/PTH3	Pull-up	47 kΩ	41	D9		
12	IRQ4#/PTH4	Pull-up	47 kΩ	42	D8		
13	D31/PTB7			43	D7		
14	D30/PTB6			44	D6		
15	D29/PTB5			45	Vss	GND	
16	D28/PTB4			46	D5		
17	D27/PTB3			47	VccQ	3.3 V	
18	D26/PTB2			48	D4		
19	Vss	GND		49	D3		
20	D25/PTB1			50	D2		
21	VccQ	3.3 V		51	D1		
22	D24/PTB0			52	D0		
23	D23/PTA7			53	A0		
24	D22/PTA6			54	A1		
25	D21/PTA5			55	A2		
26	D20/PTA4			56	A3		
27	Vss	GND		57	Vss	GND	
28	D19/PTA3			58	A4		
29	Vcc	NC		59	VccQ	3.3 V	
30	D18/PTA2			60	A5		

**Table 7.1 Pin Assignment and Handling of User System Interface (cont)**

No.	Signal Name	Handling	Notes	No.	Signal Name	Handling	Notes
61	A6			96	CS0#	Pull-up	10 kΩ
62	A7			97	VccQ	3.3 V	
63	A8			98	CS2#/PTK0	Pull-up	47 kΩ
64	A9			99	CS3#/PTK1	Pull-up	47 kΩ
65	A10			100	CS4#/PTK2	Pull-up	47 kΩ
66	A11			101	CS5#/CE1A#/PTK3	Pull-up	47 kΩ
67	A12			102	CS6#/C1B#		
68	A13			103	CE2A#/PTE4	Pull-up	47 kΩ
69	Vss	GND		104	CE2B#/PTE5	Pull-up	47 kΩ
70	A14			105	CKE/PTK5	Pull-up	47 kΩ
71	VccQ	3.3 V		106	RAS3L#/PTJ0	Pull-up	47 kΩ
72	A15			107	RAS2LA#/PTJ1	Pull-up	47 kΩ
73	A16			108	CASLL#/CAS# /PTJ2	Pull-up	47 kΩ
74	A17			109	Vss	GND	
75	A18			110	CASLH#/PTJ3	Pull-up	47 kΩ
76	A19			111	VccQ	3.3 V	
77	A20			112	CASHL#/PTJ4	Pull-up	47 kΩ
78	A21			113	CASHH#/PTJ5	Pull-up	47 kΩ
79	Vss	GND		114	DACK0#/PTD5	Pull-up	47 kΩ
80	A22			115	DACK1#/PTD7	Pull-up	47 kΩ
81	Vcc	NC		116	CAS2L/PTE6	Pull-up	47 kΩ
82	A23			117	CAS2H/PTR3	Pull-up	47 kΩ
83	Vss	GND		118	RAS3U#/PTE2	Pull-up	47 kΩ
84	A24			119	RAS2U#/PTE1	Pull-up	47 kΩ
85	VccQ	3.3 V		120	TDO/PTE0	NC	Must not be used
86	A25			121	BACK#		
87	BS#/PTK4	Pull-up	47 kΩ	122	BREQ#	Pull-up	47 kΩ
88	RD#			123	WAIT#	Pull-up	47 kΩ
89	WE0#/DQMLL			124	RESETM#	Pull-up	47 kΩ
90	WE1#/DQMLU/WE#			125	PTH5/ASTRG#	Pull-up	47 kΩ
91	WE2#/DQMUL /ICIORD#/PTK6			126	IOIS16/PTG7	Pull-up	47 kΩ
92	WE3#/DQMUU /ICIOWR#/PTK7			127	ASEMDO/PTG6	NC	Must not be used
93	RDWR#			128	ASEBRKAK/PTG5	NC	Must not be used
94	AUDSYNC/PTE7	Pull-up	47 kΩ	129	PTG4	Pull-up	47 kΩ
95	Vss	GND		130	AUDATA3/PTG3	Pull-up	47 kΩ

**Table 7.1 Pin Assignment and Handling of User System Interface (cont)**

No.	Signal Name	Handling	Notes	No.	Signal Name	Handling	Notes
131	AUDATA2/PTG2	Pull-up	47 kΩ	159	TCLK/PH7	Pull-up	47 kΩ
132	Vss	GND		160	IRQOUT#		
133	AUDATA1/PTG1	Pull-up	47 kΩ	161	Vss	GND	
134	Vcc	NC		162	CKIO	Pull-up	47 kΩ
135	AUDATA0/PTG0	Pull-up	47 kΩ	163	VccQ	3.3 V	
136	TRST/PTF7/PINT15	NC	Must not be used	164	TXD0/SCPT0		
137	TMS/PTF6/PINT14	NC	Must not be used	165	SCK0/SCPT1	Pull-up	47 kΩ
138	TDI/PTF5/PINT13	NC	Must not be used	166	TXD1/SCPT2		
139	TCK/PTF4/PINT12	NC	Must not be used	167	SCK1/SCPT3	Pull-up	47 kΩ
140	IRLS3/PTF3# /PINT11	Pull-up	47 kΩ	168	TXD2/SCPT4		
141	IRLS2/PTF2# /PINT10	Pull-up	47 kΩ	169	SCK2/SCPT5	Pull-up	47 kΩ
142	IRLS1/PTF1# /PINT9	Pull-up	47 kΩ	170	RTS2/SCPT6	Pull-up	47 kΩ
143	IRLS0/PTF0# /PINT8	Pull-up	47 kΩ	171	RXD0/SCPT0	Pull-up	47 kΩ
144	MDO	Pull-up	47 kΩ	172	RXD1/SCPT2	Pull-up	47 kΩ
145	Vcc(PLL)	NC		173	Vss	GND	
146	CAP1	NC		174	RXD2/SCPT4	Pull-up	47 kΩ
147	Vss(PLL)	NC		175	Vcc	NC	
148	Vss(PLL)	NC		176	CTS2/IRQ5#/SCPT7	Pull-up	47 kΩ
149	CAP2	NC		177	MCS7#/PTC7# /PINT7#		
150	Vcc(PLL)	NC		178	MCS6#/PTC6# /PINT6#		
151	AUDCK/PH6	Pull-up	47 kΩ	179	MCS5#/PTC5# /PINT5#		
152	Vss	GND		180	MCS4#/PTC4# /PINT4#		
153	Vss	GND		181	Vss	GND	
154	VccQ	3.3 V		182	WAKEUP#/PTD3	Pull-up	47 kΩ
155	XTAL	N.C		183	VccQ	3.3 V	
156	EXTAL	Pull-up	47 kΩ	184	RESETOUT# /PTD2#	Pull-up	47 kΩ
157	STATUS0/PTJ6	Pull-up	47 kΩ	185	MCS3#/PTC3# /PINT3#		
158	STATUS1/PTJ7	Pull-up	47 kΩ	186	MCS2#/PINT2# /PTC2#		

**Table 7.1 Pin Assignment and Handling of User System Interface (cont)**

No.	Signal Name	Handling	Notes	No.	Signal Name	Handling	Notes
187	MCS1#/PINT1# /PTC1#			198	AVss		
188	MCS0#/PINT0# /PTC0#			199	AN0/PTL0	Dumping	47 Ω
189	DRAK0/PTD1	Pull-up	47 kΩ	200	AN1/PTL1	Dumping	47 Ω
190	DRAK1/PTD0	Pull-up	47 kΩ	201	AN2/PTL2	Dumping	47 Ω
191	DREQ0#/PTD4	Pull-up	47 kΩ	202	AN3/PTL3	Dumping	47 Ω
192	DREQ1#/PTD6	Pull-up	47 kΩ	203	AN4/PTL4	Dumping	47 Ω
193	RESETP#	Pull-up	47 kΩ	204	AN5/PTL5	Dumping	47 Ω
194	CA#	Pull-up	47 kΩ	205	AVcc	3.3 V	
195	MD3	Pull-up	47 kΩ	206	AN6/DA0/PTL6	Dumping	47 Ω
196	MD4	Pull-up	47 kΩ	207	AN7/DA1/PTL7	Dumping	47 Ω
197	MD5	Pull-up	47 kΩ	208	AVss		

**Handling:**

**Pull-up:** The pin is pulled up to 3.3 V through a 47-kΩ or 10-kΩ resistor on the board.

**Dumping:** The MCU pin is connected to the user system interface connector through a 47-Ω resistor.

**3.3 V:** 3.3 V is supplied from the user system (only when SW3 is shifted to USER\_VCC).

**GND:** The pin is connected to GND on the board.

**NC:** The MCU pin is not connected to the user system interface connector.

**Blank:** The MCU pin is directly connected to the user system interface connector.

## 7.2 Signal Line Handling on the Emulation Memory Board and User System

The emulation memory board is connected to the user system through the user system interface connector (YQPACK) and the IC socket (NQPACK). Figure 7.1 shows the signal line handling on the emulation memory board and the user system.

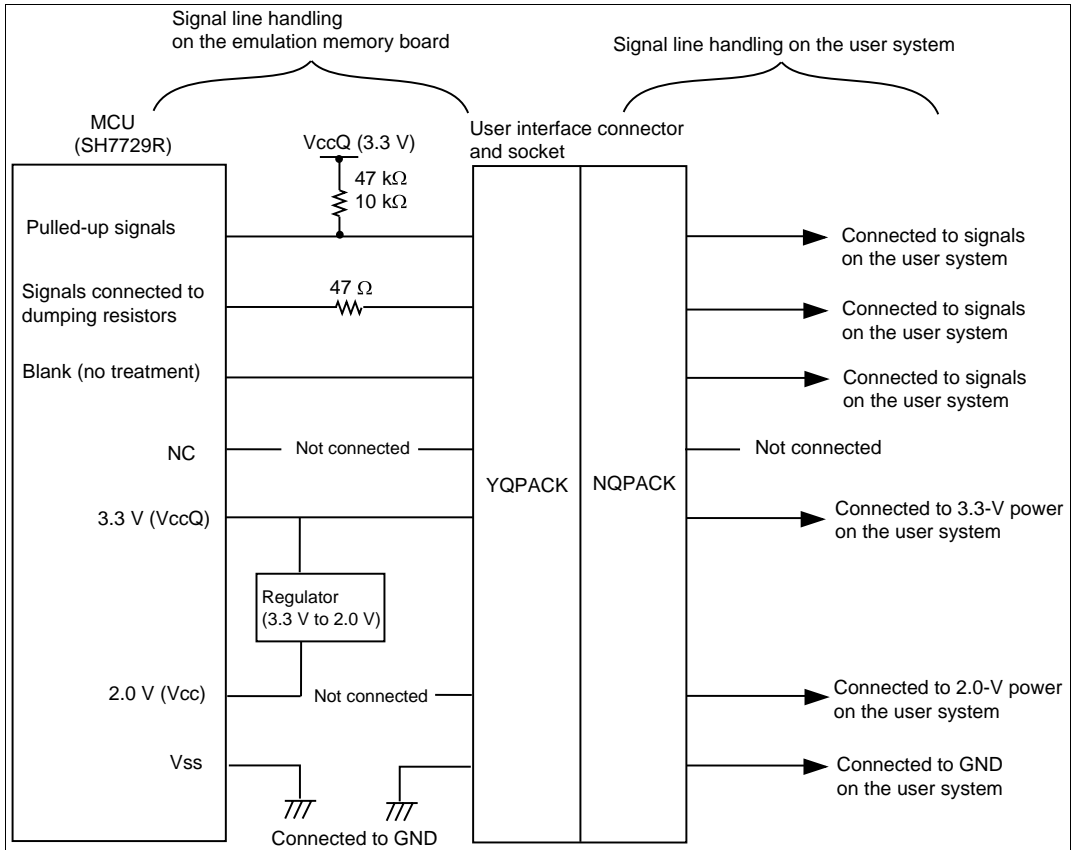
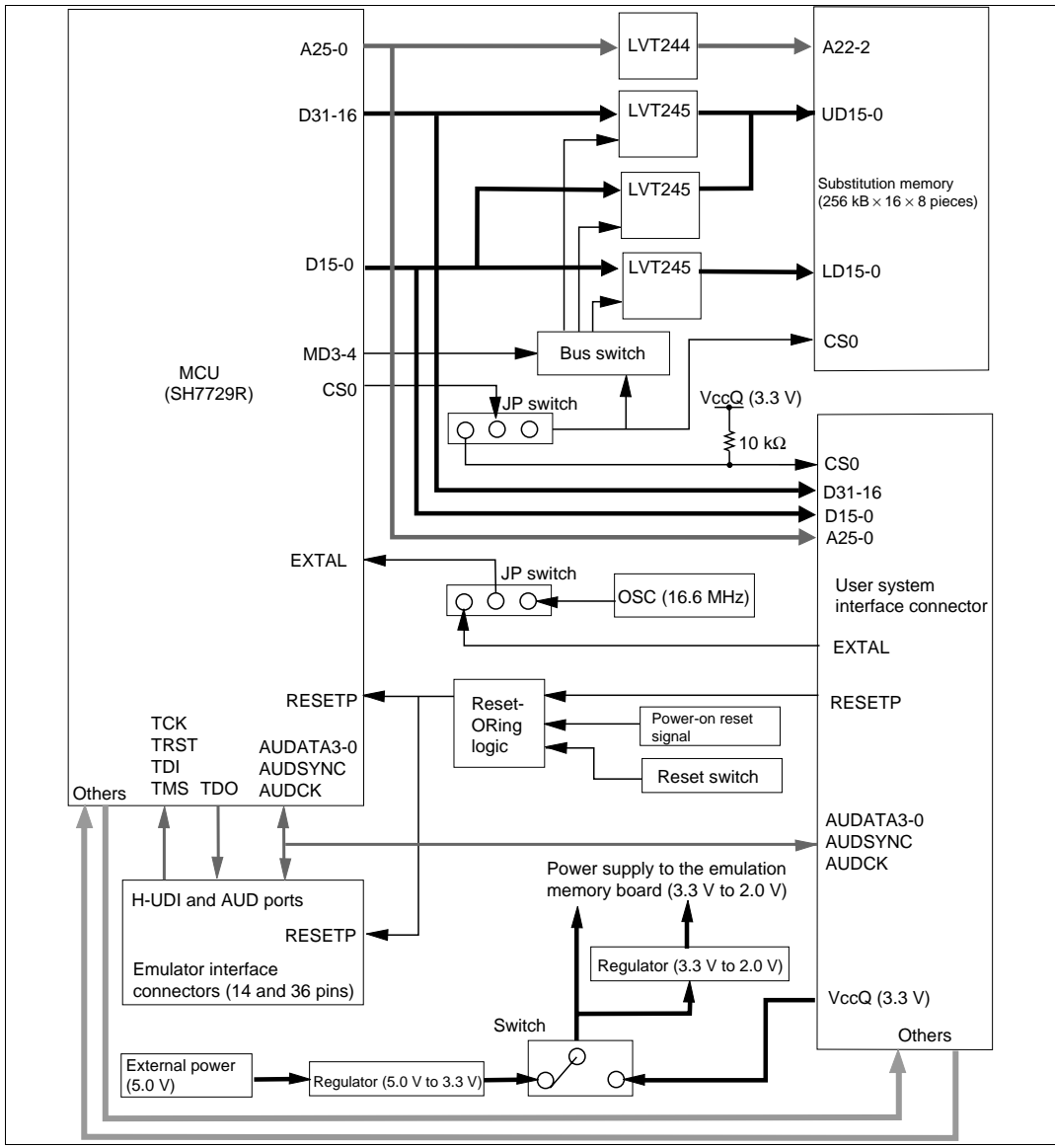

**Figure 7.1 Signal Line Handling on the Emulation Memory Board and User System**



# Section 8 Emulation Memory Board Block Diagram

The emulation memory board has an MCU (SH7729R), a user system interface connector, emulator connectors, and memory. Figure 8.1 shows the block diagram of the emulation memory board.

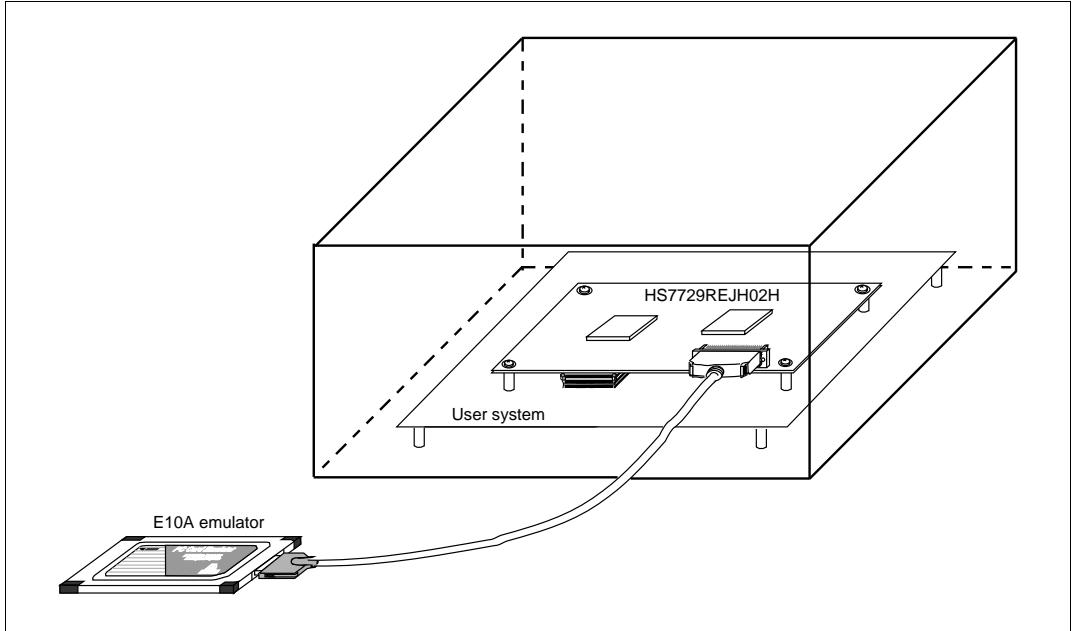

**Figure 8.1 Emulation Memory Board Block Diagram**



## Section 9 Using the Emulator in a Case

Package the emulator and the emulation memory board in a case as shown below. The recommended material of the case to prevent electrical magnetic interference (EMI) noise is iron plated with nickel or resin plated with nickel inside. The case must have enough size to hold the emulation memory board and the user system.



**Figure 9.1 Configuration for Countermeasure against EMI Noise**

Note: EMI stands for Electrical Magnetic Interference.

