

To our customers,

Old Company Name in Catalogs and Other Documents

On April 1st, 2010, NEC Electronics Corporation merged with Renesas Technology Corporation, and Renesas Electronics Corporation took over all the business of both companies. Therefore, although the old company name remains in this document, it is a valid Renesas Electronics document. We appreciate your understanding.

Renesas Electronics website: <http://www.renesas.com>

April 1st, 2010
Renesas Electronics Corporation

Issued by: Renesas Electronics Corporation (<http://www.renesas.com>)

Send any inquiries to <http://www.renesas.com/inquiry>.

Notice

1. All information included in this document is current as of the date this document is issued. Such information, however, is subject to change without any prior notice. Before purchasing or using any Renesas Electronics products listed herein, please confirm the latest product information with a Renesas Electronics sales office. Also, please pay regular and careful attention to additional and different information to be disclosed by Renesas Electronics such as that disclosed through our website.
2. Renesas Electronics does not assume any liability for infringement of patents, copyrights, or other intellectual property rights of third parties by or arising from the use of Renesas Electronics products or technical information described in this document. No license, express, implied or otherwise, is granted hereby under any patents, copyrights or other intellectual property rights of Renesas Electronics or others.
3. You should not alter, modify, copy, or otherwise misappropriate any Renesas Electronics product, whether in whole or in part.
4. Descriptions of circuits, software and other related information in this document are provided only to illustrate the operation of semiconductor products and application examples. You are fully responsible for the incorporation of these circuits, software, and information in the design of your equipment. Renesas Electronics assumes no responsibility for any losses incurred by you or third parties arising from the use of these circuits, software, or information.
5. When exporting the products or technology described in this document, you should comply with the applicable export control laws and regulations and follow the procedures required by such laws and regulations. You should not use Renesas Electronics products or the technology described in this document for any purpose relating to military applications or use by the military, including but not limited to the development of weapons of mass destruction. Renesas Electronics products and technology may not be used for or incorporated into any products or systems whose manufacture, use, or sale is prohibited under any applicable domestic or foreign laws or regulations.
6. Renesas Electronics has used reasonable care in preparing the information included in this document, but Renesas Electronics does not warrant that such information is error free. Renesas Electronics assumes no liability whatsoever for any damages incurred by you resulting from errors in or omissions from the information included herein.
7. Renesas Electronics products are classified according to the following three quality grades: “Standard”, “High Quality”, and “Specific”. The recommended applications for each Renesas Electronics product depends on the product’s quality grade, as indicated below. You must check the quality grade of each Renesas Electronics product before using it in a particular application. You may not use any Renesas Electronics product for any application categorized as “Specific” without the prior written consent of Renesas Electronics. Further, you may not use any Renesas Electronics product for any application for which it is not intended without the prior written consent of Renesas Electronics. Renesas Electronics shall not be in any way liable for any damages or losses incurred by you or third parties arising from the use of any Renesas Electronics product for an application categorized as “Specific” or for which the product is not intended where you have failed to obtain the prior written consent of Renesas Electronics. The quality grade of each Renesas Electronics product is “Standard” unless otherwise expressly specified in a Renesas Electronics data sheets or data books, etc.
 - “Standard”: Computers; office equipment; communications equipment; test and measurement equipment; audio and visual equipment; home electronic appliances; machine tools; personal electronic equipment; and industrial robots.
 - “High Quality”: Transportation equipment (automobiles, trains, ships, etc.); traffic control systems; anti-disaster systems; anti-crime systems; safety equipment; and medical equipment not specifically designed for life support.
 - “Specific”: Aircraft; aerospace equipment; submersible repeaters; nuclear reactor control systems; medical equipment or systems for life support (e.g. artificial life support devices or systems), surgical implantations, or healthcare intervention (e.g. excision, etc.), and any other applications or purposes that pose a direct threat to human life.
8. You should use the Renesas Electronics products described in this document within the range specified by Renesas Electronics, especially with respect to the maximum rating, operating supply voltage range, movement power voltage range, heat radiation characteristics, installation and other product characteristics. Renesas Electronics shall have no liability for malfunctions or damages arising out of the use of Renesas Electronics products beyond such specified ranges.
9. Although Renesas Electronics endeavors to improve the quality and reliability of its products, semiconductor products have specific characteristics such as the occurrence of failure at a certain rate and malfunctions under certain use conditions. Further, Renesas Electronics products are not subject to radiation resistance design. Please be sure to implement safety measures to guard them against the possibility of physical injury, and injury or damage caused by fire in the event of the failure of a Renesas Electronics product, such as safety design for hardware and software including but not limited to redundancy, fire control and malfunction prevention, appropriate treatment for aging degradation or any other appropriate measures. Because the evaluation of microcomputer software alone is very difficult, please evaluate the safety of the final products or system manufactured by you.
10. Please contact a Renesas Electronics sales office for details as to environmental matters such as the environmental compatibility of each Renesas Electronics product. Please use Renesas Electronics products in compliance with all applicable laws and regulations that regulate the inclusion or use of controlled substances, including without limitation, the EU RoHS Directive. Renesas Electronics assumes no liability for damages or losses occurring as a result of your noncompliance with applicable laws and regulations.
11. This document may not be reproduced or duplicated, in any form, in whole or in part, without prior written consent of Renesas Electronics.
12. Please contact a Renesas Electronics sales office if you have any questions regarding the information contained in this document or Renesas Electronics products, or if you have any other inquiries.

(Note 1) “Renesas Electronics” as used in this document means Renesas Electronics Corporation and also includes its majority-owned subsidiaries.

(Note 2) “Renesas Electronics product(s)” means any product developed or manufactured by or for Renesas Electronics.

Renesas Starter Kit for H8SX1664

User's Manual

RENEASAS SINGLE-CHIP MICROCOMPUTER
H8SX FAMILY

Table of Contents

Table of Contents	ii
Chapter 1. Preface	4
Chapter 2. Purpose	5
Chapter 3. Power Supply	6
3.1. Requirements	6
3.2. Power – Up Behaviour	6
Chapter 4. Board Layout	7
4.1. Component Layout	7
4.2. Board Dimensions	8
Chapter 5. Block Diagram	9
Chapter 6. User Circuitry	10
6.1. Switches	10
6.2. LEDs	10
6.3. Potentiometer	10
6.4. Serial port	10
6.5. LCD Module	11
6.6. Option Links	12
6.7. Oscillator Sources	16
6.8. Reset Circuit	16
6.9. USB Port	17
Chapter 7. Modes	18
7.1. FDT Settings	18
7.1.1. Boot mode	19
7.1.2. User Mode	20
Chapter 8. Programming Methods	21
8.1. E8 Header	21
8.2. E10A Header	21
8.3. USB port programming	21
8.4. Serial Port Programming	22
Chapter 9. Headers	23
9.1. Microcontroller Headers	23
9.2. Application Headers	27
Chapter 10. Code Development	30
10.1. Overview	30
10.2. Compiler Restrictions	30
10.3. Mode Support	30
10.4. Breakpoint Support	30
10.5. Code located in RAM	30

10.6. HMON Code Size	30
10.7. Memory Map	32
10.8. Baud Rate Setting.....	33
10.9. Interrupt mask sections	33
Chapter 11. Component Placement.....	34
Chapter 12. Additional Information	35

Chapter 1. Preface

Cautions

This document may be, wholly or partially, subject to change without notice.

All rights reserved. No one is permitted to reproduce or duplicate, in any form, a part or this entire document without the written permission of Renesas Technology Europe Limited.

Trademarks

All brand or product names used in this manual are trademarks or registered trademarks of their respective companies or organisations.

Copyright

© Renesas Technology Europe Ltd. 2006. All rights reserved.

© Renesas Technology Corporation. 2006. All rights reserved.

© Renesas Solutions Corporation. 2006. All rights reserved.

Website: <http://www.renesas.com/>

Glossary

ADC	Analog to Digital Converter
BRR	Baud Rate Register
CPU	Central Processing Unit
DAC	Digital to Analog Converter
DMA	Direct Memory Access
ERR	Error Rate
FDT	Flash Development Tool
HMON	Embedded Monitor
RTE	Renesas Technology Europe Ltd.
RSK	Renesas Starter Kit
RSO	Renesas Solutions Corp.
USB	Universal Serial Bus

Chapter 2.Purpose

This RSK is an evaluation tool for Renesas microcontrollers.

Features include:

- Renesas Microcontroller Programming.
- User Code Debugging.
- User Circuitry such as switches, LEDs and potentiometer(s).
- Sample Application.
- Sample peripheral device initialisation code.

The CPU board contains all the circuitry required for microcontroller operation.

This manual describes the technical details of the RSK hardware. The Quick Start Guide and Tutorial Manual provide details of the software installation and debugging environment.

Chapter 3. Power Supply

3.1. Requirements

This CPU board operates from a 5V power supply.

A diode provides reverse polarity protection only if a current limiting power supply is used.

All CPU boards are supplied with an E8 debugger. This product is able to power the CPU board with up to 300mA. When the CPU board is connected to another system that system should supply power to the CPU board.

All CPU boards have an optional centre positive supply connector using a 2.0mm barrel power jack.

Warning

The CPU board is neither under not over voltage protected. Use a centre positive supply for this board.

3.2. Power – Up Behaviour

When the RSK is purchased the CPU board has the 'Release' or stand alone code from the example tutorial code pre-programmed into the Renesas microcontroller. On powering up the board the user LEDs will start to flash. Switch 2 will cause the LEDs to flash at a rate controlled by the potentiometer.

Chapter 4.Board Layout

4.1.Component Layout

The following diagram shows top layer component layout of the board.

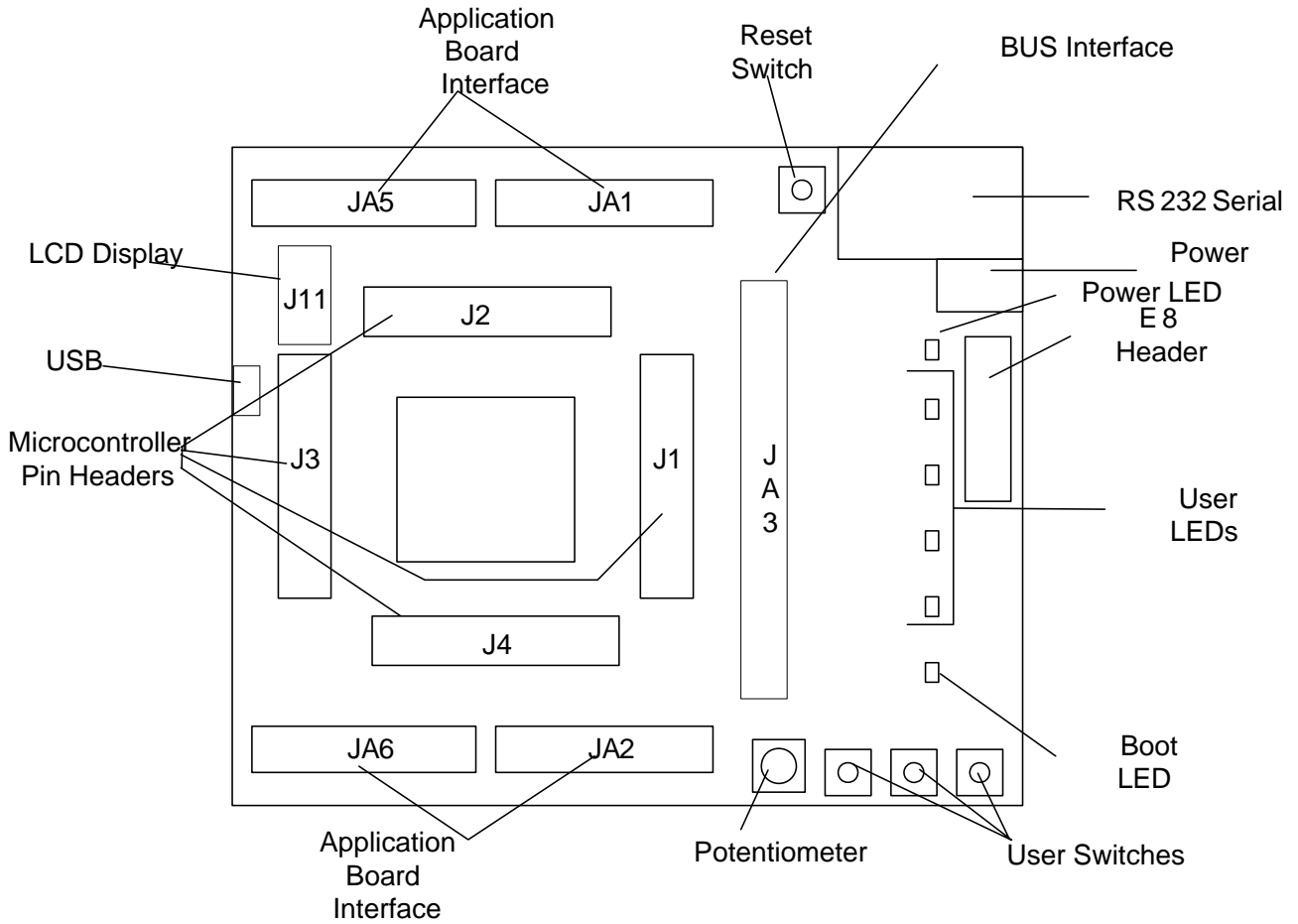

Figure 4.1: Board Layout

4.2.Board Dimensions

The following diagram gives the board dimensions and connector positions. All through hole connectors are on a common 0.1" grid for easy interfacing.

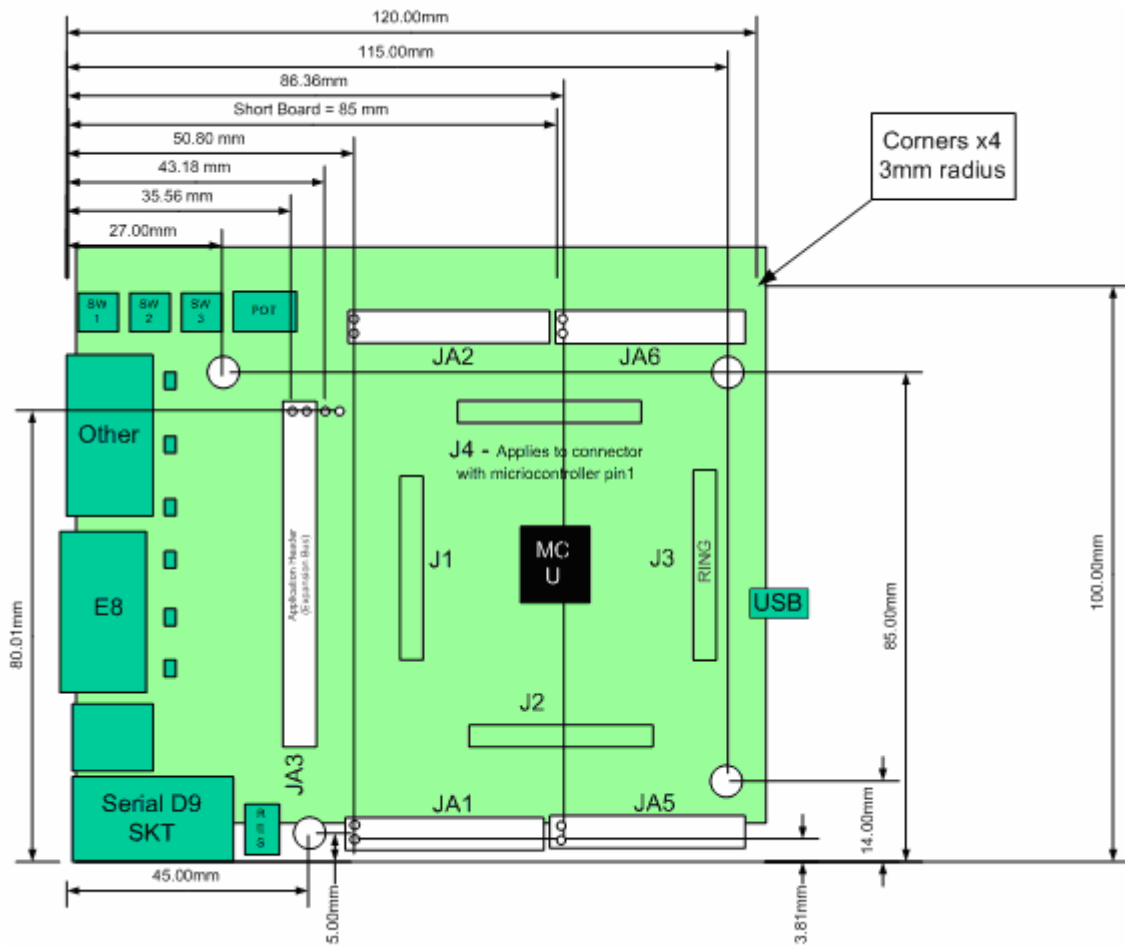

Figure 4.2 : Board Dimensions

Chapter 5. Block Diagram

Figure 5.1 shows the CPU board components and their connectivity.

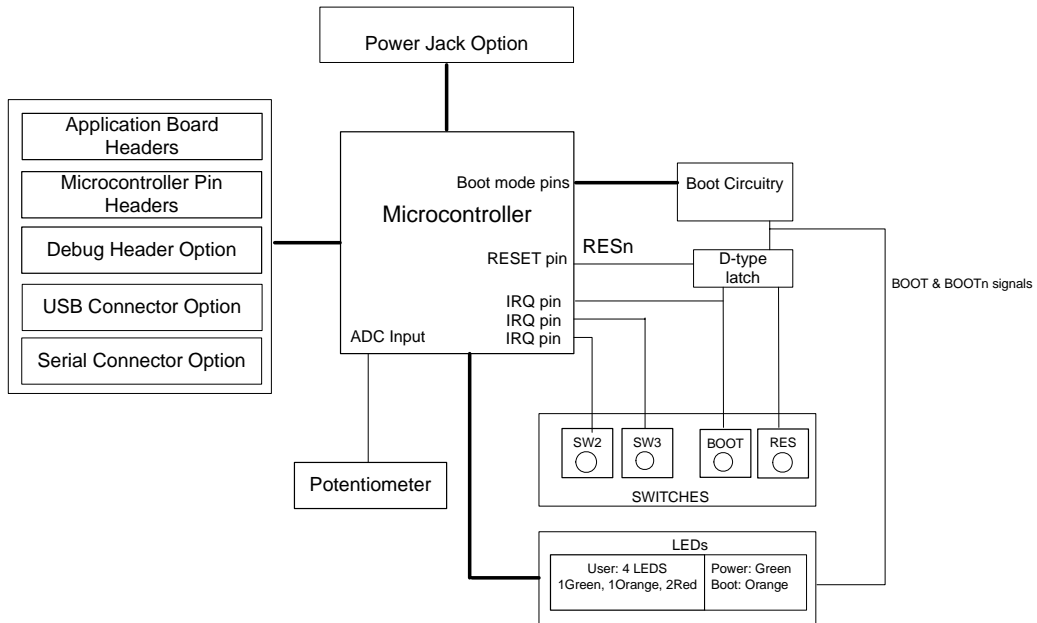

Figure 5.1: Block Diagram

Figure 5.2 shows the connections to the RSK.

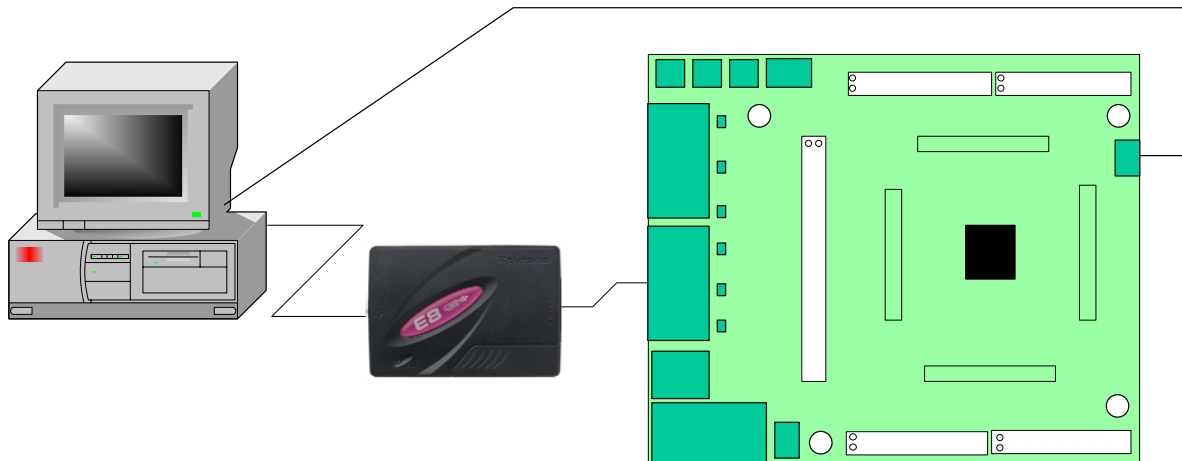

Figure 5.2 : RSK Connctions

Chapter 6. User Circuitry

6.1. Switches

There are four switches located on the CPU board. The function of each switch and its connection are shown in Table 6-1.

Switch	Function	Microcontroller
RES	When pressed; the CPU board microcontroller is reset.	RESn
SW1/BOOT*	Connects to an IRQ input for user controls. The switch is also used in conjunction with the RES switch to place the device in BOOT mode when not using the E8 debugger.	IRQ0n, Pin 84 (Port 1, pin 0)
SW2*	Connects to an IRQ line for user controls.	IRQ1n, Pin 85 (Port 1, pin 1)
SW3*	Connects to the ADC trigger input. Option link allows connection to IRQ line. The option is a pair of 0R links (R56, R95).	IRQ3n, Pin 87 (Port 1, pin 3)

Table 6-1: Switch Functions

*Refer to schematic for detailed connectivity information.

6.2. LEDs

There are six LEDs on the CPU board. The green 'POWER' LED lights when the board is powered. The orange BOOT LED indicates the device is in BOOT mode when lit. The four user LEDs are connected to an IO port and will light when their corresponding port pin is set low.

Table 6-2, below, shows the LED pin references and their corresponding microcontroller port pin connections.

LED Reference (As shown on silkscreen)	Microcontroller Port Pin function	Microcontroller Pin Number	Polarity
LED0	Port B3	3	Active Low
LED1	Port C2	116	Active Low
LED2	Port C3	117	Active Low
LED3	Port 12	86	Active Low

Table 6-2: LED Port

6.3. Potentiometer

A single turn potentiometer is connected to AN0 of the microcontroller. This may be used to vary the input analog voltage value to this pin between AVCC and Ground.

6.4. Serial port

The microcontroller programming serial port (SCI4) is connected to the E8 connector (J6). This serial port can optionally be connected to the RS232 transceiver by moving option resistors and fitting the D connector in position J8. The connections to be moved are listed in the following table.

Description	Function	Fit For E8	Remove for E8	Fit for RS232	Remove for RS232
SCI4 Tx	Programming Serial Port	R6	R37	R37	R6
SCI4 Rx	Programming Serial Port	R5	R36	R36	R5

Table 6-3 - Serial Option Links

The board is designed to accept a straight through RS232 cable. A secondary microcontroller serial port is available and connected to the application headers. Please refer to the schematic diagram for more details on the available connections.

6.5.LCD Module

A LCD module can be connected to the connector J11. Any module that conforms to the pin connections and has a KS0066u compatible controller can be used with the tutorial code. The LCD module uses a 4bit interface to reduce the pin allocation. No contrast control is provided; this must be set on the display module.

Table 6-4 shows the pin allocation and signal names used on this connector.

The module supplied with the CPU board only supports 5V operation.

J13					
Pin	Circuit Net Name	Device Pin	Pin	Circuit Net Name	Device Pin
1	Ground	-	2	5V Only	-
3	No Connection	-	4	DLCDRS	134
5	R/W (Wired to Write only)	-	6	DLCDE	136
7	No Connection	-	8	No connection	-
9	No Connection	-	10	No connection	-
11	DLCDD4	130	12	DLCDD5	131
13	DLCDD6	132	14	DLCDD7	5

Table 6-4 LCD Module Connections

6.6.Option Links

Table 6-5 below describes the function of the option links contained on this CPU board. The default configuration is indicated by **BOLD** text.

Option Link Settings				
Reference	Function	Fitted	Alternative (Removed)	Related To
R3	Power Source	Board can be powered from J7	Disable external power connector	R13, R22, R40, R43
R4	E8	Enables E8		
R5	Serial Port Configuration	Connects programming port (Rx) to E8 connector.	Disconnects programming port (Rx) from E8 connector.	R6, R36, R37
R6	Serial Port Configuration	Connects programming port (Tx) to E8 connector.	Disconnects programming port (Tx) from E8 connector.	R5, R36, R37
R13	Power Source	Board is powered from VBUS	Board is powered by another source	R3, R22, R40, R43
R15	Serial Port Configuration	Connects serial port D5 (Tx) to D-type connector (J8).	Disconnects serial port D5 (Rx) from D-type connector (J8).	R28, R34, R35
R18	Power Source	Connects external 3.3V power source to the board.	Disconnects external 3.3V power source from the board.	R3, R13, R22, R40, R43
R19	RS232 Serial	Disables RS232 Serial Transceiver	Enables RS232 Serial Transceiver	
R21	Analog Voltage Source	Analog voltage source from on board Vcc.	Analog Voltage Source from external connector.	R46
R22	Power Source	Board can be powered from E8	Disable E8 power source	R3, R13, R40, R43
R24	MCU Power Supply	Supply to MCU	Fit Low ohm resistor to measure current	
R28	Serial Port Configuration	Connects serial port D5 (Rx) to D-type connector (J8).	Disconnects serial port D5 (Tx) from D-type connector (J8).	R15, R34, R35
R30	Serial Port Configuration	Routes serial port D0 (Rx) to application connector (JA2)	Disconnects serial port D0 (Rx) from application connector (JA2)	R31
R31	Serial Port Configuration	Routes serial port D0 (Tx) to application connector (JA2)	Disconnects serial port D0 (Tx) from application connector (JA2)	R30
R32	Serial Port Configuration	Routes programming port (Tx) to application connector (JA6)	Disconnects programming port (Tx) from application connector (JA6)	R33
R33	Serial Port Configuration	Routes programming port (Rx) to application connector (JA6)	Disconnects programming port (Rx) from application connector (JA6)	R32

Option Link Settings				
Reference	Function	Fitted	Alternative (Removed)	Related To
R34	Serial Port Configuration	Connects serial port D5 (Tx) to D-type (J8) or programming connectors (J9).	Disconnects serial port D5 (Tx) from D-type (J8) or programming connectors (J9).	R15, R28, R35,
R35	Serial Port Configuration	Connects serial port D5 (Rx) to D-type (J8) or programming connectors (J9).	Disconnects serial port D5 (Rx) from D-type (J8) or programming connectors (J9).	R15, R28, R34
R36	Serial Port Configuration	Connects programming port (Rx) to external connectors (not E8).	Disconnects programming port (Rx) to external connectors (not E8).	R5, R6, R37
R37	Serial Port Configuration	Connects programming port (Tx) to external connectors (not E8).	Disconnects programming port (Tx) to external connectors (not E8).	R5, R6, R37
R40	Power Source	Board is powered by 5V source.	Board is powered by a 3.3V source.	R3, R13, R18, R22, R43
R42	Ground Signals	Links analog ground to digital ground.	Isolates analog ground from digital ground.	
R44	Power Source	Microprocessor uses USB Bus Power Mode.	Microprocessor uses USB Self Power Mode.	
R46	Analog Voltage Source	Analog Voltage Source from external connector.	Analog voltage source from on board Vcc.	R21
R47	LCD Power Source	LCD powered from External 5V source (J7).	LCD Powered from a different source.	R49, R51
R48	CON_5V Connection	CON_5V connected to External power source (J7).	CON_5V connected to a different source.	R50, R52
R49	LCD Power Source	LCD powered from VBUS 5V source.	LCD powered from a different source.	R47, R51
R50	CON_5V Connection	CON_5V connected to VBUS 5V source	CON_5V connected to a different source.	R48, R52
R51	LCD Power Source	LCD powered from E8.	LCD powered from a different source.	R47, R49
R52	CON_5V Connection	CON_5V connected to E8	CON_5V connected to a different source.	R48, R50
R54	Application Board Interface	Use WDT_OVF of application board interface	Use TDO of application board interface	R123
R56	Application Board Interface	Enable ADTRG of application board interface	Use IRQ3n of application board interface	R95

Option Link Settings				
Reference	Function	Fitted	Alternative (Removed)	Related To
R59	Application Board Interface	Use RxD0 of application board interface	Use IO1 of application board interface	R76
R60	Application Board Interface	Use AN0 of application board interface	Use AD_POT of application board interface	R96
R64	Voltage Reference Source	Voltage Reference set to board Vcc signal	Voltage Reference taken from external connector (J4).	R83
R66	Application Board Interface	Use CLK0 of application board interface	Use TDO of application board interface	R79
R67	Application Board Interface	Use IO3 of application board interface	Use UD of application board interface	R78
R68	Application Board Interface	Use DA0 of application board interface	Use AN6 of application board interface	R108
R69	Up	Connects Motor control Up to the microprocessor	Disconnects Motor control Up from the microprocessor	R114
R70	Application Board Interface	Use TxDO of application board interface	Use IO2 of application board interface	R82
R71	Application Board Interface	Use DA1 of application board interface	Use AN7 of application board interface	R111
R74	Wn	Connects Motor control Wn to the microprocessor	Disconnects Motor control Wn from the microprocessor	R88
R75	Vp	Connects Motor control Vp to the microprocessor	Disconnects Motor control Vp from the microprocessor	R81
R76	Application Board Interface	Use IO1 of application board interface	Use RxD0 of application board interface	R59
R78	Application Board Interface	Use UD of application board interface	Use IO3 of application board interface	R67
R79	Application Board Interface	Use IO0 of application board interface	Use CLK0 of application board interface	R66
R81	Application Board Interface	Use TIOCA0 of application board interface	Use Vp of application board interface	R75
R82	Application Board Interface	Use IO2 of application board interface	Use TxDO of application board interface	R70
R83	Voltage Reference Source	Voltage Reference taken from external connector (J4).	Voltage Reference set to board Vcc signal.	R64
R84	Vn	Connects Motor control Vn to the microprocessor	Disconnects Motor control Vn from the microprocessor	R90

Option Link Settings				
Reference	Function	Fitted	Alternative (Removed)	Related To
R85	Application Board Interface	Use IO5 of application board interface	Use Wp of application board interface	R86
R86	Wp	Connects Motor control Wp to the microprocessor	Disconnects Motor control Wp from the microprocessor	R85
R88	Application Board Interface	Use IO4 of application board interface	Use Wn of application board interface	R74
R90	Application Board Interface	Use TIOCB0 of application board interface	Use Vn of application board interface	R84
R93	Sub Clock Oscillator Source	External Clock Source	Crystal	R94, R103, R105
R94	Sub Clock Oscillator Source	External Clock Source	Crystal	R93, R103, R105
R95	Application Board Interface	Enable IRQ3n of application board interface	Use ADTRG of application board interface	R56
R96	Application Board Interface	Use AD_POT of application board interface	Use AN0 of application board interface	R60
R98	External Subclock Oscillator	Parallel resistor for crystal	Not fitted	
R99	Processor Oscillator Source	External Clock Source	Crystal	
R100	External main Oscillator	Parallel resistor for crystal	Not fitted	
R101	Processor Oscillator Source	Crystal	External Clock Source	
R102	Processor Oscillator Source	External Clock Source	Crystal	
R103	Sub Clock Oscillator Source	Crystal	External Clock Source	R93, R94, R105
R105	Sub Clock Oscillator Source	Crystal	External Clock Source	R93, R94, R103
R108	Application Board Interface	Use AN6 of application board interface	Use DA0 of application board interface	R68
R111	Application Board Interface	Use AN7 of application board interface	Use DA1 of application board interface	R71
R114	Application Board Interface	Use TIOCA2 of application board interface	Use Up of application board interface	R69
R115	Un	Connects Motor control Un to the microprocessor	Disconnects Motor control Un from the microprocessor	R116
R116	Application Board Interface	Use TIOCB2 of application board interface	Use Un of application board interface	R115
R123	Application Board Interface	Use TD0 of application board interface	Use WDTOVF of application board interface	R54

Option Link Settings				
Reference	Function	Fitted	Alternative (Removed)	Related To
R129	Boot Mode Selection	Enables E8 to control the boot mode selection.	Allows application control of the boot mode.	R133
R130	Crystal Selection	Fit if 16MHz Crystal Fitted	12MHz Crystal Fitted	
R131	Memory Selection	Fit to enable SDRAM	<i>Default</i>	
R132	Debugging Adaptor	Enables Debugging via the E10 adaptor.	Enables Debugging via the E8 adaptor.	
R133	Boot Mode Selection	Enables Serial Boot Mode	<i>Default</i>	R129

Table 6-6: 2-Pin jumpers

6.7. Oscillator Sources

A crystal oscillator is fitted on the CPU board and used to supply the main clock input to the Renesas microcontroller. A second crystal oscillator is provided to drive the real time clock. Table 6-7 details the oscillators that are fitted and alternative footprints provided on this CPU board:

Component		
Crystal (X1)	Fitted	12MHz (HC49/4H package)
Crystal (X2)	Fitted	32.768KHz (90SMX package)

Table 6-7: Oscillators / Resonators

Warning: When replacing the default oscillator with that of another frequency, the debugging monitor will not function unless the following are corrected:

- FDT programming kernels supplied are rebuilt for the new frequency
- The supplied HMON debugging monitor is updated for baud rate register settings.

The user is responsible for code written to support operating speeds other than the default. See the HMON User Manual for details of making the appropriate modifications in the code to accommodate different operating frequencies.

6.8. Reset Circuit

The CPU Board includes a simple latch circuit that links the mode selection and reset circuit. This provides an easy method for swapping the device between Boot Mode, User Boot Mode and User mode. This circuit is not required on customer's boards as it is intended for providing easy evaluation of the operating modes of the device on the RSK. Please refer to the hardware manual for more information on the requirements of the reset circuit.

The reset circuit operates by latching the state of the boot switch on pressing the reset button. This control is subsequently used to modify the mode pin states as required.

The mode pins should change state only while the reset signal is active to avoid possible device damage.

The reset is held in the active state for a fixed period by a pair of resistors and a capacitor. Please check the reset requirements carefully to ensure the reset circuit on the user's board meets all the reset timing requirements.

6.9.USB Port

This RSK has a Full-speed (12 Mbps) USB port compliant to USB 2.0 specification. It is available as J12 on the RSK. This port allows Boot mode programming using **USB Direct** connection which does not require E8. For more details please refer to *H8SX/1663 Group Hardware Manual*.

Chapter 7.Modes

The CPU board supports User mode and Boot mode. User mode may be used to run and debug user code, while Boot mode may only be used to program the Renesas microcontroller with program code. To program the user boot MAT, the device must be in Boot mode. Further details of programming the MATs are available in the H8SX/1663 Group hardware manual.

When using the E8 debugger supplied with the RSK the mode transitions are executed automatically. The CPU board provides the capability of changing between User and Boot / User Boot modes using a simple latch circuit. This is only to provide a simple mode control on this board when the E8 is not in use.

To manually enter boot mode, press and hold the SW1/BOOT. The mode pins are held in their boot states while reset is pressed and released. Release the boot button. The BOOT LED will be illuminated to indicate that the microcontroller is in boot mode.

More information on the operating modes can be found in the device hardware manual.

7.1.FDT Settings

In the following sections the tables identify the FDT settings required to connect to the board using the E8Direct debugger interface. The 'A' interface is inverted on the RSK board. This is to ensure the board can function in a known state when the E8 is connected but not powered. The E8 Debugger contains the following 'pull' resistors.

E8 Pin	Resistor
A	Pull Down (100k)
B	Pull Up (100k)
C	Pull Down (100k)
D	Pull Up (100k)

Table 7-1: E8 Mode Pin drives

7.1.1.Boot mode

The boot mode settings for this CPU board are shown in Table 7-2 below:

MD2	MD1	MD0	LSI State after Reset End	FDT Settings	
				A	B
0	1	0	Boot Mode	0	0

Table 7-2: Mode pin settings

The following picture shows these settings made in the E8Direct configuration dialog from HEW.

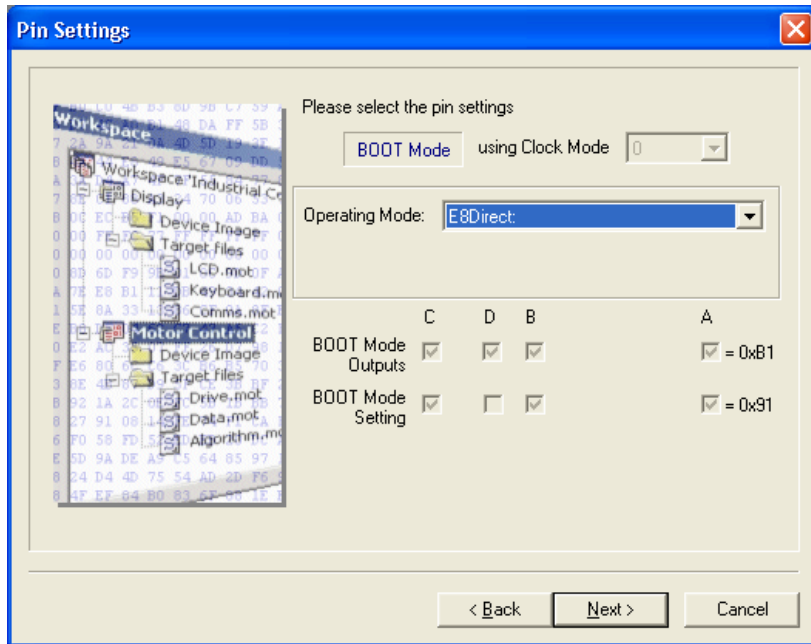

Figure 7.1: Boot Mode FDT configuration

7.1.2. User Mode

For the device to enter User Mode, reset must be held active while the microcontroller mode pins are held in states specified for User Mode operation. 100K pull up and pull down resistors are used to set the pin states during reset.

The H8SX/1664 supports 4 user modes. The memory map in all of these modes is 16Mbyte in size. The default user mode for CPU board supporting H8SX1664 is 7.

MD2	MD1	MD0	LSI State after Reset End	FDT Settings	
				A	B
1	1	1	User Mode	0	1

Table 7-3: Mode pin settings

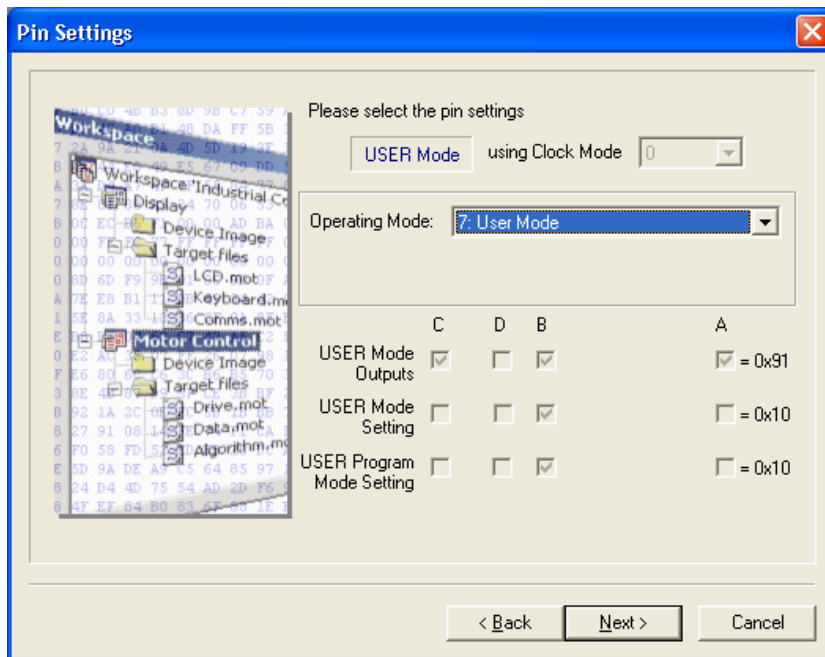

Figure 7.2: User mode FDT configuration

Chapter 8. Programming Methods

All of the Flash ROM on the device (i.e. both MATs) can be programmed when the device is in Boot mode. Once in boot mode, the boot-loader program pre-programmed into the microcontroller executes and attempts a connection with a host (for example a PC). On establishing a connection with the microcontroller, the host may then transmit program data to the microcontroller via the appropriate programming port.

Table 8-1 below shows the programming port for this Renesas Microcontroller and its associated pins

Programming Port Table – Programming port pins and their CPU board signal names		
E8 Port (J6)	E8_TXD, PIN 5	E8_RXD, PIN 11
CPU board Signal Name	PTTX (Port 6, Pin0)	PTRX (Port 6, Pin 1)

Table 8-1: Serial Port Boot Channel

8.1.E8 Header

This device supports an E8 debugging interface. The E8 provides additional debugging features including hardware breakpoints and hardware trace capability. (Check with the website at www.renesas.com or your distributor for a full feature list).

Connect the E8 to port J6.

To enable the E8 functions the user must ensure that the jumper link in position J15 is removed.

8.2.E10A Header

This device supports an optional E10A debugging interface. The E10A provides additional debugging features including hardware breakpoints and hardware trace capability. (Check with the website at www.renesas.com or your distributor for a full feature list).

To utilise the E10A the user will need to fit a 14 way boxed header to J5. To enable the E10A functions the user should also fit a jumper link in position J15.

When J15 is fitted the microcontroller will not operate correctly unless operated via the E10A.

8.3.USB port programming

The microcontroller must enter boot mode for programming, and the programming port must be connected to a host for program download.

To execute the boot transition, and allow programs to download to the microcontroller, the user must perform the following procedure:

Ensure jumper link in position J16 and R133 are not fitted. (Default position)

Press the BOOT switch and keep this held down.

Press the RESET switch once, and release.

Release the BOOT switch The BOOT LED will be illuminated.

Now connect a USB cable between the host PC and the RSK at J12.

The Flash Development Toolkit (FDT) is supplied to allow programs to be loaded directly on to the board using this method. Please select **USB Direct** interface while downloading the program.

8.4. Serial Port Programming

This sequence is not required when debugging using the E8 supplied with the kit.

The microcontroller must enter boot mode for programming, and the programming port must be connected to a host for program download. To execute the boot transition, and allow programs to download to the microcontroller, the user must perform the following procedure:

Fit a jumper link in position J16 or fit R133.

Perform the link changes described in section 6.4 to enable serial debug.

Connect a 1:1 serial cable between the host PC and the CPU board J8.

Depress the BOOT switch and keep this held down.

Depress the RESET switch once, and release.

Release the BOOT switch. The BOOT LED will be illuminated.

The Flash Development Toolkit (FDT) is supplied to allow programs to be loaded directly on to the board using this method.

Chapter 9.Headers

9.1.Microcontroller Headers

Table 9-1 to Table 9-4 show the microcontroller pin headers and their corresponding microcontroller connections. The header pins connect directly to the microcontroller pin unless otherwise stated.

J1					
Pin	Circuit Net Name	Device Pin	Pin	Circuit Net Name	Device Pin
1	CS1n	1	2	CS2n	2
3	LED0	3	4	Ground	4
5	DLCDD7	5	6	UC_VCC	6
7	MD2	7	8	TxD6	8
9	RxD6	9	10	PM2	10
11	A23	11	12	A22	12
13	A21	13	14	A20	14
15	A19	15	16	Ground	16
17	A18	17	18	A17	18
19	A16	19	20	A15	20
21	A14	21	22	A13	22
23	Ground	23	24	A12	24
25	UC_VCC	25	26	A11	26
27	A10	27	28	A9	28
29	A8	29	30	A7	30
31	A6	31	32	Ground	
33	A5	33	34	A4	34
35	A3	35	35	A2	36

Table 9-1: J1

J2					
Pin	Circuit Net Name	Device Pin	Pin	Circuit Net Name	Device Pin
1	A1	37	2	A0	38
3	EMLE	39	4	PM3	40
5	PM4	41	6	UC_VCC	32
7	No connection		8	No connection	
9	Ground	32	10	VBUS_DET	46
11	MD_CLK	47	12	Ground	48
13	IO0_CLK0	49	14	UC_VCC	50
15	IO1_RxD0	51	16	IO2_TxD0	52
17	IO3_UD	53	18	IO4_Wn	54
19	IO5_Wp	55	20	TIOCA0_Vp	56
21	TIOCB0_Vn	57	22	TRISTn	58
23	IO6	59	24	IO7	60
25	NMI _n	61	26	DREQ1 _n	62
27	TEND1 _n	63	28	UC_VCC	64
29	D0	65	30	D1	66
31	D2	67	32	D3	68
33	Ground	69	34	D4	70
35	D5	71	36	D6	72

Table 9-2: J2

J3					
Pin	Circuit Net Name	Device Pin	Pin	Circuit Net Name	Device Pin
1	D7	73	2	UC_VCC	64
3	D8	75	4	D9	76
5	D10	77	6	D11	78
7	Ground	79	8	D12	80
9	D13	81	10	D14	82
11	D15	83	12	IRQ0n	84
13	IRQ1n	85	14	LED3	86
15	IRQ3n_ADTRG	87	16	Ground	79
17	CON_OSC2	89*	18	CON_OSC1	90*
19	RESn	91	20	No connection	
21	TxD5	93	22	RxD5	94
23	WDTOVF_TDO	95	24	Ground	88
25	CON_XTAL	98*	26	CON_EXTAL	97*
27	UC_VCC	99	28	P1_6	100
29	P1_7	101	30	STBYn	102
31	Ground	103	32	DACK1n	104
33	TIOCA2_Up	105	34	TIOCB2_Un	106
35	PTTX	108	36	PTRX	107

Table 9-3: J3

J4					
Pin	Circuit Net Name	Device Pin	Pin	Circuit Net Name	Device Pin
1	TRSTn	109	2	UC_VCC	99
3	TMS	111	4	Ground	96
5	TDI	113	6	TCK	114
7	MD0	115	8	LED1	116
9	LED2	117	10	ADPOT_AN0	118
11	AN1	119	12	AN2	120
13	CON_AVCC	121*	14	AN3	122
15	AVss	123	16	AN4	124
17	CON_VREF	125*	18	AN5	126
19	DA0_AN6	127	20	DA1_AN7	128
21	MD1	129	22	DLCDD4	130
23	DLCDD5	131	24	DLCDD6	132
25	MD3	133	26	DLCDRS	134
27	WRn	135	28	DLCDE	136
29	LLWRn	137	30	LHWRn	138
31	RDn	139	32	ASn	140
33	Ground	141	34	BCLK	142
35	UC_VCC	143	36	CS0n	144

Table 9-4: J4

9.2.Application Headers

Table 9-5 and Table 9-6 below show the standard application header connections.

JA1							
Pin	Generic Header Name	CPU board Signal Name	Device Pin	Pin	Generic Header Name	CPU board Signal Name	Device Pin
1	Regulated Supply (5V)	---	---	2	Regulated Supply 1 (Gnd)	---	---
3	Regulated Supply (3V3)	---	---	4	Regulated Supply 2 (Gnd)	---	---
5	Analogue Supply	AVcc*	121	6	Analogue Supply	AVss	123
7	Analogue Reference	AVref*	125	8	ADTRG	ADTRG*	87
9	AN0	AD0*	118	10	AD1	AN1	119
11	AN2	AD2	120	12	AD3	AN3	122
13	DAC0	DAC0*	127	14	DAC1	DA1*	128
15	IOPort	IO0*	49	16	IOPort	IO1*	51
17	IOPort	IO2*	52	18	IOPort	IO3*	53
19	IOPort	IO4*	54	20	IOPort	IO5*	55
21	IOPort	IO6	59	22	IOPort	IO7	60
23	Open drain	IRQ3n	IRQ3n*	87	IIC_EX	---	---
25	IIC_SDA	SDA0	100	26	IIC_SCL	SCL0	101

Table 9-5: JA1 Standard Generic Header

JA2							
Pin	Generic Header Name	CPU board Signal Name	Device Pin	Pin	Generic Header Name	CPU board Signal Name	Device Pin
1	Open drain	RESn	91	2	External Clock Input	CON_EXTAL*	98
3	Open drain	NMIIn	61	4	Regulated Supply (Vss)	---	---
5	Open drain output	WDT_OVF*	95	6	Serial Port	TxD0*	52
7	Open drain	WUP	IRQ0	84	Serial Port	RxD0*	51
9	Open drain	IRQ1	85	10	Serial Port	CLK0*	49
11	Up/down	UD*	53	12	Serial Port Handshake	---	---
13	Motor control	Up*	105	14	Motor control	Un*	106
15	Motor control	Vp*	56	16	Motor control	Vn*	57
17	Motor control	Wp*	55	18	Motor control	Wn*	54
19	Output	TIOCA0*	56	20	Output	TIOCA2*	105
21	Input	TIOCB0*	57	22	Input	TIOCB2*	106
23	Open drain	IRQ3n*	87	24	Tristate Control	TRISTn	58
25	Reserved	---	---	26	Reserved	---	---

Table 9-6: JA2 Standard Generic Header

JA3							
Pin	Generic Header Name	CPU board Signal Name	Device Pin	Pin	Generic Header Name	CPU board Signal Name	Device Pin
1	Address Bus	A0	38	2	Address Bus	A1	37
3	Address Bus	A2	36	4	Address Bus	A3	35
5	Address Bus	A4	34	6	Address Bus	A5	33
7	Address Bus	A6	31	8	Address Bus	A7	30
9	Address Bus	A8	29	10	Address Bus	A9	28
11	Address Bus	A10	27	12	Address Bus	A11	26
13	Address Bus	A12	24	14	Address Bus	A13	22
15	Address Bus	A14	21	16	Address Bus	A15	20
17	Data Bus	D0	65	18	Data Bus	D1	66
19	Data Bus	D2	67	20	Data Bus	D3	68
21	Data Bus	D4	70	22	Data Bus	D5	71
23	Data Bus	D6	72	24	Data Bus	D7	73
25	Read/Write Control	RDn	139	26	Bus Acknowledge	WRn	135
27	Memory Select	CS0n	144	28	Memory Select	CS1n	1
29	Data Bus	D8	75	30	Data Bus	D9	76
31	Data Bus	D10	77	32	Data Bus	D11	78
33	Data Bus	D12	80	34	Data Bus	D13	81
35	Data Bus	D14	82	36	Data Bus	D15	83
37	Address Bus	A16	19	38	Address Bus	A17	18
39	Address Bus	A18	17	40	Address Bus	A19	15
41	Address Bus	A20	14	42	Address Bus	A21	13
43	Address Bus	A22	12	44	External Device Clock	BCLK	142
45	Memory Select	CS2n	2	46	Bus Control	ASn	140
47	Data Bus Strobe	LHWRn	138	48	Data Bus Strobe	LLWRn	137
49	Reserved			50	Reserved		

Table 9-7: JA3 Standard Generic Header

JA5							
Pin	Generic Header Name	CPU board Signal Name	Device Pin	Pin	Generic Header Name	CPU board Signal Name	Device Pin
1	AD4	AN4	124	2	AD5	AN5	126
3	AD6	AN6*	127	4	AD7	AN7*	128
5	CAN1TX	---	---	6	CAN1RX	---	---
7	CAN2TX	---	---	8	CAN2RX	---	---
9	Reserved			10	Reserved		
11	Reserved			12	Reserved		
13	Reserved			14	Reserved		
15	Reserved			16	Reserved		
17	Reserved			18	Reserved		
19	Reserved			20	Reserved		
21	Reserved			22	Reserved		
23	Reserved			24	Reserved		

Table 9-8: JA5 Optional Generic Header

JA6									
Pin	Generic Header Name		CPU board Signal Name	Device Pin	Pin	Generic Header Name		CPU board Signal Name	Device Pin
1	DMA		DREQ1n	62	2	DMA		DACK1n	104
3	DMA		TEND1n	63	4	Standby (Open drain)		---	---
5	Host Serial	SCIdTX	RS232TX*	---	6	Host Serial	SCIdRX	RS232RX*	---
7	Serial Port		RxD5	94	8	Serial Port		TxD5	93
9	Serial Port	Synchronous	TxD6	8	10	Serial Port		---	---
11	Serial Port	Synchronous	---	---	12	Serial Port	Synchronous	RxD6	9
13	Reserved				14	Reserved			
15	Reserved				16	Reserved			
17	Reserved				18	Reserved			
19	Reserved				20	Reserved			
21	Reserved				22	Reserved			
23	Reserved				24	Reserved			
25	Reserved				26	Reserved			

Table 9-9: JA6 Optional Generic Header

* Marked pins are affected by option links (see 6.6).

Chapter 10.Code Development

10.1.Overview

Note: For all code debugging using Renesas software tools, the CPU board must either be connected to a PC serial port via a serial cable or a PC USB port via an E8. An E8 is supplied with the RSK product.

The HMON embedded monitor code is modified for each specific Renesas microcontroller. HMON enables the High-performance Embedded Workshop (HEW) development environment to establish a connection to the microcontroller and control code execution. Breakpoints may be set in memory to halt code execution at a specific point.

Unlike other embedded monitors, HMON is designed to be integrated with the user code. HMON is supplied as a library file and several configuration files. When debugging is no longer required, removing the monitor files and library from the code will leave the user's code operational.

The HMON embedded monitor code must be compiled with user software and downloaded to the CPU board, allowing the users' code to be debugged within HEW.

Due to the continuous process of improvements undertaken by Renesas the user is recommended to review the information provided on the Renesas website at www.renesas.com to check for the latest updates to the Compiler and Debugger manuals.

10.2.Compiler Restrictions

The compiler supplied with this RSK is fully functional for a period of 60 days from first use. After the first 60 days of use have expired, the compiler will default to a maximum of 64k code and data. To use the compiler with programs greater than this size you will need to purchase the full tools from your distributor.

Warning: The protection software for the compiler will detect changes to the system clock. Changes to the system clock back in time may cause the trial period to expire prematurely.

10.3.Mode Support

The HMON library is built to support 16Mbyte Advanced Mode only for the H8SX family.

10.4.Breakpoint Support

The device does not include a user break controller. No breakpoints can be located in ROM code. However, code located in RAM may have multiple breakpoints limited only by the size of the On-Chip RAM. To debug with breakpoints in ROM you need to purchase the E10A-USB on-chip debugger at additional cost.

10.5.Code located in RAM

Double clicking in the breakpoint column in the HEW code window sets the breakpoint. Breakpoints will remain unless they are double clicked to remove them. (See the Tutorial Manual for more information on debugging with the HEW environment.)

10.6.HMON Code Size

HMON is built along with the user's code. Certain elements of the HMON code must remain at a fixed location in memory. Table 10-1 details the HMON components and their size and location in memory. For more information, refer to the map file when building code.

Section	Description	Start Location	Size (H'bytes)
RESET_VECTOR	HMON Reset Vector (Vector 0) Required for Start-up of HMON	H' 0000 0000	0x0004
SCI_VECTORS	HMON Serial Port Vectors (Vector 160, 161, 162, 163)	H'0000 0280	0x000C
PHMON	HMON Code	H'0000 3000	0x276A
CHMON	HMON Constant Data	H'0000 576a	0x0136
BHMON	HMON Un-initialised data	Variable	0x021F
UGenU	FDT Kernel. This is at a fixed location and must not be moved. Should the kernel need to be moved it must be re-compiled.	H'0000 1000	0xE71
CUser_Vectors	Pointer used by HMON to point to the start of user code.	H'0000 0800	0x0004

Table 10-1: Memory Map for HMON Components

10.7.Memory Map

The memory map shown in this section visually describes the locations of program code sections related to HMON, the FDT kernels and the supporting code within the ROM/RAM memory areas of the microcontroller.

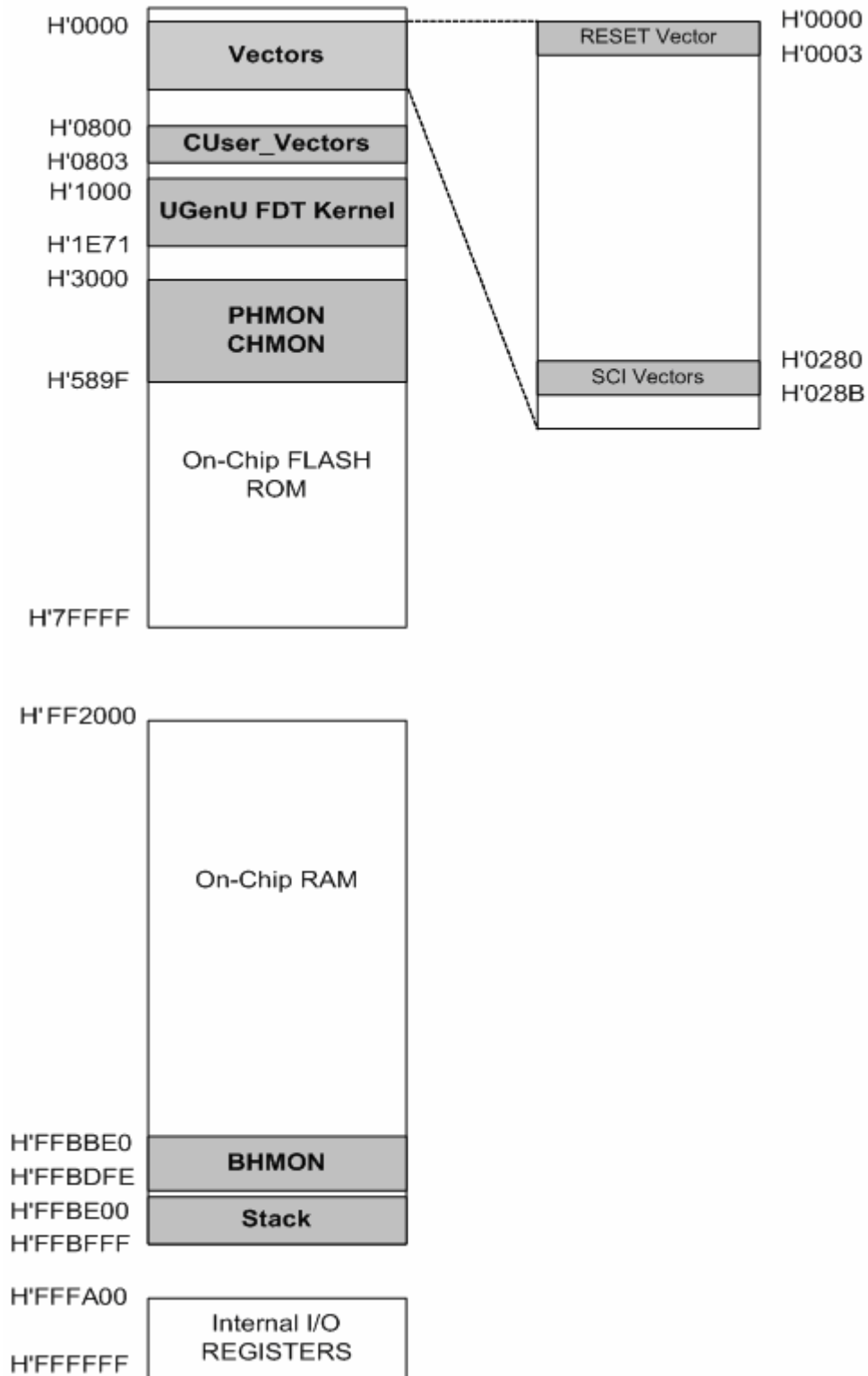

Figure 10.1: Memory Map

10.8. Baud Rate Setting

HMON is initially set to connect at 250000Baud. The value set in the baud rate register for the microcontroller must be altered if the user wishes to change either the serial communication baud rate of the serial port or the operating frequency of the microcontroller. This value is defined in the `hmonserialconfiguser.h` file, as `SCI_CFG_BRR` (see the Serial Port section for baud rate register setting values). The project must be re-built and the resulting code downloaded to the microcontroller once the BRR value is changed. Please refer to the HMON User Manual for further information.

10.9. Interrupt mask sections

HMON has an interrupt priority of 6. The serial port has an interrupt priority of 7. Modules using interrupts should be set to lower than this value (6 or below), so that serial communications and debugging capability is maintained.

Chapter 12. Additional Information

For details on how to use High-performance Embedded Workshop (HEW), refer to the HEW manual available on the CD or installed in the Manual Navigator.

For information about the H8SX/1664 series microcontrollers refer to the *H8SX/1663 Group Hardware Manual*

For information about the H8SX/1664 assembly language, refer to the *H8SX Series Programming Manual*

Further information available for this product can be found on the Renesas website at:

http://www.renesas.com/renesas_starter_kits

General information on Renesas Microcontrollers can be found on the following website.

Global: <http://www.renesas.com/>

Renesas Starter Kit for H8SX1664

User's Manual

Publication Date Rev.1.00

Published by: Renesas Technology Europe Ltd.

Dukes Meadow, Millboard Road, Bourne End Buckinghamshire

SL8 5FH, United Kingdom

©2006 Renesas Technology Europe and Renesas Solutions Corp., All Rights Reserved.

Renesas Starter Kit for H8SX1664 User's Manual



Renesas Electronics Corporation

1753, Shimonumabe, Nakahara-ku, Kawasaki-shi, Kanagawa 211-8668 Japan

REG10J0025-0100