

To our customers,

Old Company Name in Catalogs and Other Documents

On April 1st, 2010, NEC Electronics Corporation merged with Renesas Technology Corporation, and Renesas Electronics Corporation took over all the business of both companies. Therefore, although the old company name remains in this document, it is a valid Renesas Electronics document. We appreciate your understanding.

Renesas Electronics website: <http://www.renesas.com>

April 1st, 2010
Renesas Electronics Corporation

Issued by: Renesas Electronics Corporation (<http://www.renesas.com>)

Send any inquiries to <http://www.renesas.com/inquiry>.

Notice

1. All information included in this document is current as of the date this document is issued. Such information, however, is subject to change without any prior notice. Before purchasing or using any Renesas Electronics products listed herein, please confirm the latest product information with a Renesas Electronics sales office. Also, please pay regular and careful attention to additional and different information to be disclosed by Renesas Electronics such as that disclosed through our website.
2. Renesas Electronics does not assume any liability for infringement of patents, copyrights, or other intellectual property rights of third parties by or arising from the use of Renesas Electronics products or technical information described in this document. No license, express, implied or otherwise, is granted hereby under any patents, copyrights or other intellectual property rights of Renesas Electronics or others.
3. You should not alter, modify, copy, or otherwise misappropriate any Renesas Electronics product, whether in whole or in part.
4. Descriptions of circuits, software and other related information in this document are provided only to illustrate the operation of semiconductor products and application examples. You are fully responsible for the incorporation of these circuits, software, and information in the design of your equipment. Renesas Electronics assumes no responsibility for any losses incurred by you or third parties arising from the use of these circuits, software, or information.
5. When exporting the products or technology described in this document, you should comply with the applicable export control laws and regulations and follow the procedures required by such laws and regulations. You should not use Renesas Electronics products or the technology described in this document for any purpose relating to military applications or use by the military, including but not limited to the development of weapons of mass destruction. Renesas Electronics products and technology may not be used for or incorporated into any products or systems whose manufacture, use, or sale is prohibited under any applicable domestic or foreign laws or regulations.
6. Renesas Electronics has used reasonable care in preparing the information included in this document, but Renesas Electronics does not warrant that such information is error free. Renesas Electronics assumes no liability whatsoever for any damages incurred by you resulting from errors in or omissions from the information included herein.
7. Renesas Electronics products are classified according to the following three quality grades: “Standard”, “High Quality”, and “Specific”. The recommended applications for each Renesas Electronics product depends on the product’s quality grade, as indicated below. You must check the quality grade of each Renesas Electronics product before using it in a particular application. You may not use any Renesas Electronics product for any application categorized as “Specific” without the prior written consent of Renesas Electronics. Further, you may not use any Renesas Electronics product for any application for which it is not intended without the prior written consent of Renesas Electronics. Renesas Electronics shall not be in any way liable for any damages or losses incurred by you or third parties arising from the use of any Renesas Electronics product for an application categorized as “Specific” or for which the product is not intended where you have failed to obtain the prior written consent of Renesas Electronics. The quality grade of each Renesas Electronics product is “Standard” unless otherwise expressly specified in a Renesas Electronics data sheets or data books, etc.
 - “Standard”: Computers; office equipment; communications equipment; test and measurement equipment; audio and visual equipment; home electronic appliances; machine tools; personal electronic equipment; and industrial robots.
 - “High Quality”: Transportation equipment (automobiles, trains, ships, etc.); traffic control systems; anti-disaster systems; anti-crime systems; safety equipment; and medical equipment not specifically designed for life support.
 - “Specific”: Aircraft; aerospace equipment; submersible repeaters; nuclear reactor control systems; medical equipment or systems for life support (e.g. artificial life support devices or systems), surgical implantations, or healthcare intervention (e.g. excision, etc.), and any other applications or purposes that pose a direct threat to human life.
8. You should use the Renesas Electronics products described in this document within the range specified by Renesas Electronics, especially with respect to the maximum rating, operating supply voltage range, movement power voltage range, heat radiation characteristics, installation and other product characteristics. Renesas Electronics shall have no liability for malfunctions or damages arising out of the use of Renesas Electronics products beyond such specified ranges.
9. Although Renesas Electronics endeavors to improve the quality and reliability of its products, semiconductor products have specific characteristics such as the occurrence of failure at a certain rate and malfunctions under certain use conditions. Further, Renesas Electronics products are not subject to radiation resistance design. Please be sure to implement safety measures to guard them against the possibility of physical injury, and injury or damage caused by fire in the event of the failure of a Renesas Electronics product, such as safety design for hardware and software including but not limited to redundancy, fire control and malfunction prevention, appropriate treatment for aging degradation or any other appropriate measures. Because the evaluation of microcomputer software alone is very difficult, please evaluate the safety of the final products or system manufactured by you.
10. Please contact a Renesas Electronics sales office for details as to environmental matters such as the environmental compatibility of each Renesas Electronics product. Please use Renesas Electronics products in compliance with all applicable laws and regulations that regulate the inclusion or use of controlled substances, including without limitation, the EU RoHS Directive. Renesas Electronics assumes no liability for damages or losses occurring as a result of your noncompliance with applicable laws and regulations.
11. This document may not be reproduced or duplicated, in any form, in whole or in part, without prior written consent of Renesas Electronics.
12. Please contact a Renesas Electronics sales office if you have any questions regarding the information contained in this document or Renesas Electronics products, or if you have any other inquiries.

(Note 1) “Renesas Electronics” as used in this document means Renesas Electronics Corporation and also includes its majority-owned subsidiaries.

(Note 2) “Renesas Electronics product(s)” means any product developed or manufactured by or for Renesas Electronics.

M30870T2-CPE

User's Manual

Compact Emulator for M32C/87 Group

Notes regarding these materials

1. This document is provided for reference purposes only so that Renesas customers may select the appropriate Renesas products for their use. Renesas neither makes warranties or representations with respect to the accuracy or completeness of the information contained in this document nor grants any license to any intellectual property rights or any other rights of Renesas or any third party with respect to the information in this document.
2. Renesas shall have no liability for damages or infringement of any intellectual property or other rights arising out of the use of any information in this document, including, but not limited to, product data, diagrams, charts, programs, algorithms, and application circuit examples.
3. You should not use the products or the technology described in this document for the purpose of military applications such as the development of weapons of mass destruction or for the purpose of any other military use. When exporting the products or technology described herein, you should follow the applicable export control laws and regulations, and procedures required by such laws and regulations.
4. All information included in this document such as product data, diagrams, charts, programs, algorithms, and application circuit examples, is current as of the date this document is issued. Such information, however, is subject to change without any prior notice. Before purchasing or using any Renesas products listed in this document, please confirm the latest product information with a Renesas sales office. Also, please pay regular and careful attention to additional and different information to be disclosed by Renesas such as that disclosed through our website. (<http://www.renesas.com>)
5. Renesas has used reasonable care in compiling the information included in this document, but Renesas assumes no liability whatsoever for any damages incurred as a result of errors or omissions in the information included in this document.
6. When using or otherwise relying on the information in this document, you should evaluate the information in light of the total system before deciding about the applicability of such information to the intended application. Renesas makes no representations, warranties or guaranties regarding the suitability of its products for any particular application and specifically disclaims any liability arising out of the application and use of the information in this document or Renesas products.
7. With the exception of products specified by Renesas as suitable for automobile applications, Renesas products are not designed, manufactured or tested for applications or otherwise in systems the failure or malfunction of which may cause a direct threat to human life or create a risk of human injury or which require especially high quality and reliability such as safety systems, or equipment or systems for transportation and traffic, healthcare, combustion control, aerospace and aeronautics, nuclear power, or undersea communication transmission. If you are considering the use of our products for such purposes, please contact a Renesas sales office beforehand. Renesas shall have no liability for damages arising out of the uses set forth above.
8. Notwithstanding the preceding paragraph, you should not use Renesas products for the purposes listed below:
 - (1) artificial life support devices or systems
 - (2) surgical implantations
 - (3) healthcare intervention (e.g., excision, administration of medication, etc.)
 - (4) any other purposes that pose a direct threat to human life

Renesas shall have no liability for damages arising out of the uses set forth in the above and purchasers who elect to use Renesas products in any of the foregoing applications shall indemnify and hold harmless Renesas Technology Corp., its affiliated companies and their officers, directors, and employees against any and all damages arising out of such applications.
9. You should use the products described herein within the range specified by Renesas, especially with respect to the maximum rating, operating supply voltage range, movement power voltage range, heat radiation characteristics, installation and other product characteristics. Renesas shall have no liability for malfunctions or damages arising out of the use of Renesas products beyond such specified ranges.
10. Although Renesas endeavors to improve the quality and reliability of its products, IC products have specific characteristics such as the occurrence of failure at a certain rate and malfunctions under certain use conditions. Please be sure to implement safety measures to guard against the possibility of physical injury, and injury or damage caused by fire in the event of the failure of a Renesas product, such as safety design for hardware and software including but not limited to redundancy, fire control and malfunction prevention, appropriate treatment for aging degradation or any other applicable measures. Among others, since the evaluation of microcomputer software alone is very difficult, please evaluate the safety of the final products or system manufactured by you.
11. In case Renesas products listed in this document are detached from the products to which the Renesas products are attached or affixed, the risk of accident such as swallowing by infants and small children is very high. You should implement safety measures so that Renesas products may not be easily detached from your products. Renesas shall have no liability for damages arising out of such detachment.
12. This document may not be reproduced or duplicated, in any form, in whole or in part, without prior written approval from Renesas.
13. Please contact a Renesas sales office if you have any questions regarding the information contained in this document, Renesas semiconductor products, or if you have any other inquiries.

Regulatory Compliance Notices

European Union regulatory notices on Electromagnetic compatibility

CE Certifications:

This product complies with the following European EMC standards.

- EMC Directive 2004/108/EC
EN 55022 Class A

WARNING: This is a Class A product. In a domestic environment this product may cause radio interference in which case the user may be required to take adequate measures.

EN 55024

Information for traceability:

- Authorised representative
 - Name: Renesas Technology Corp.
 - Address: Nippon Bldg., 2-6-2, Ote-machi, Chiyoda-ku, Tokyo 100-0004, Japan
- Manufacturer
 - Name: Renesas Solutions Corp.
 - Address: Nippon Bldg., 2-6-2, Ote-machi, Chiyoda-ku, Tokyo 100-0004, Japan
- Person responsible for placing on the market
 - Name: Renesas Technology Europe Limited European Headquarters
 - Address: Dukes Meadow, Millboard Road, Bourne End, Buckinghamshire, SL8 5FH, U.K.

United States Regulatory notices on Electromagnetic compatibility

FCC Certifications:

This equipment has been tested and found to comply with the limits for a Class A digital device, pursuant to Part 15 of the FCC Rules. These limits are designed to provide reasonable protection against harmful interference when the equipment is operated in a commercial environment. This equipment generates, uses, and can radiate radio frequency energy and, if not installed and used in accordance with the instruction manual, may cause harmful interference to radio communications. Operation of this equipment in a residential area is likely to cause harmful interference in which case the user will be required to correct the interference at his own expense.

This device complies with Part 15 of the FCC Rules. Operation is subject to the following two conditions: (1) this device may not cause harmful interference, and (2) this device must accept any interference received, including interference that may cause undesired operation.

CAUTION: Changes or modifications not expressly approved by the party responsible for compliance could void the user's authority to operate the equipment.

Preface

The M30870T2-CPE is a compact emulator for the M32C/87 Group MCUs with the real-time trace function.

This user's manual mainly describes specifications of the M30870T2-CPE compact emulator and how to setup it. For details on the following products included with the M30870T2-CPE, refer to each product's online manual.

- Emulator debugger: M32C Compact Emulator Debugger
- C compiler: M3T-NC308WA (evaluation version)
- Integrated development environment: High-performance Embedded Workshop

All the components of this product are shown in "1.1 Package Components" (page 14). If there is any question or doubt about this product, contact your local distributor.

The related manuals for using this product are listed below. You can download the latest manuals from the Renesas Tools homepage (<http://www.renesas.com/en/tools>).

Related manuals

Item	Manual
Accessory tools	M3T-100LCC-DMS User's Manual
	M3T-DUMMY100S User's Manual
	M3T-DIRECT100S User's Manual
	M3T-FLX-100NRB User's Manual
	M3T-100LCC-QSD User's Manual
	M3T-FLX-100NSD User's Manual
	M3T-F160-100NSD User's Manual
	M3T-FLX-144NSD User's Manual
Emulator debugger	M32C Compact Emulator Debugger User's Manual
C compiler	NC308 User's Manual
Assembler	AS308 User's Manual
Integrated development environment	High-performance Embedded Workshop User's Manual

Important

Before using this product, be sure to read this user's manual carefully.

Keep this user's manual, and refer to this when you have questions about this product.

Emulator:

The emulator in this document refers to the following products that are manufactured by Renesas Technology Corp.:

- (1) Compact emulator main unit
- (2) Package converter board for connecting the user system

The emulator herein does not include the customer's user system and host machine.

Purpose of use of the emulator:

This emulator is a device to support the development of a system that uses the M16C Family M32C/80 Series and M32C/87 Group of Renesas 16/32-bit single-chip MCUs. It provides support for system development in both software and hardware.

Be sure to use this emulator correctly according to said purpose of use. Please avoid using this emulator for other than its intended purpose of use.

For those who use this emulator:

This emulator can only be used by those who have carefully read the user's manual and know how to use it.

Use of this emulator requires the basic knowledge of electric circuits, logical circuits, and MCUs.

When using the emulator:

- (1) This product is a development supporting unit for use in your program development and evaluation stages. In mass-producing your program you have finished developing, be sure to make a judgment on your own risk that it can be put to practical use by performing integration test, evaluation, or some experiment else.
- (2) In no event shall Renesas Solutions Corp. be liable for any consequence arising from the use of this product.
- (3) Renesas Solutions Corp. strives to renovate or provide a workaround for product malfunction at some charge or without charge. However, this does not necessarily mean that Renesas Solutions Corp. guarantees the renovation or the provision under any circumstances.
- (4) This product has been developed by assuming its use for program development and evaluation in laboratories. Therefore, it does not fall under the application of Electrical Appliance and Material Safety Law and protection against electromagnetic interference when used in Japan.
- (5) Renesas Solutions Corp. cannot predict all possible situations or possible cases of misuse where a potential danger exists. Therefore, the warnings written in this user's manual and the warning labels attached to this emulator do not necessarily cover all of such possible situations or cases. Please be sure to use this emulator correctly and safely on your own responsibility.

Usage restrictions:

This emulator has been developed as a means of supporting system development by users. Therefore, do not use it as a device used for equipment-embedded applications. Also, do not use it for developing the systems or equipment used for the following purposes either:

- (1) Transportation and vehicular
- (2) Medical (equipment where human life is concerned)
- (3) Aerospace
- (4) Nuclear power control
- (5) Undersea repeater

If you are considering the use of this emulator for one of the above purposes, please be sure to consult your local distributor.

About product changes:

We are constantly making efforts to improve the design and performance of this emulator. Therefore, the specification or design of this emulator or its user's manual may be changed without prior notice.

About the rights:

- (1) We assume no responsibility for any damage or infringement on patent rights or any other rights arising from the use of any information, products or circuits presented in this user's manual.
- (2) The information or data in this user's manual does not implicitly or otherwise grant a license for patent rights or any other rights belonging to us or third parties.
- (3) This user's manual and this emulator are copyrighted, with all rights reserved by us. This user's manual may not be copied, duplicated or reproduced, in whole or part, without prior written consent of us.

About diagrams:

The diagrams in this user's manual may not all represent exactly the actual object.

Precautions for Safety

Definitions of Signal Words

In both the user's manual and on the product itself, several icons are used to insure proper handling of this product and also to prevent injuries to you or other persons, or damage to your properties.

This chapter describes the precautions which should be taken in order to use this product safely and properly. Be sure to read this chapter before using this product.



This symbol represents a warning about safety. It is used to arouse caution about a potential danger that will possibly inflict an injury on persons. To avoid a possible injury or death, please be sure to observe the safety message that follows this symbol.



DANGER

DANGER indicates an imminently dangerous situation that will cause death or heavy wound unless it is avoided. However, there are no instances of such danger for the product presented in this user's manual.



WARNING

WARNING indicates a potentially dangerous situation that will cause death or heavy wound unless it is avoided.



CAUTION

CAUTION indicates a potentially dangerous situation that will cause a slight injury or a medium-degree injury unless it is avoided.

CAUTION

CAUTION with no safety warning symbols attached indicates a potentially dangerous situation that will cause property damage unless it is avoided.

IMPORTANT

This is used in operation procedures or explanatory descriptions to convey exceptional conditions or cautions to the user.

In addition to the five above, the following are also used as appropriate.

△ means WARNING or CAUTION.

Example:



CAUTION AGAINST AN ELECTRIC SHOCK

⊘ means PROHIBITION.

Example:



DISASSEMBLY PROHIBITED

● means A FORCIBLE ACTION.

Example:



UNPLUG THE POWER CABLE FROM THE RECEPTACLE.

WARNING

Warnings for AC Power Supply:



- If the attached AC power cable does not fit the receptacle, do not alter the AC power cable and do not plug it forcibly. Failure to comply may cause electric shock and/or fire.

- Use an AC power cable which complies with the safety standard of the country.
- Do not touch the plug of the AC power cable when your hands are wet. This may cause electric shock.
- This product is connected signal ground with frame ground. If your developing product is transformless (not having isolation transformer of AC power), this may cause electric shock. Also, this may give an unreparable damage to this product and your developing one.
While developing, connect AC power of the product to commercial power through isolation transformer in order to avoid these dangers.
- If other equipment is connected to the same branch circuit, care should be taken not to overload the circuit.
- Use the power supply which complies with CE marking requirements.



- When installing this equipment, insure that a reliable ground connection is maintained.



- If you smell a strange odor, hear an unusual sound, or see smoke coming from this product, then disconnect power immediately by unplugging the AC power cable from the outlet.

Do not use this as it is because of the danger of electric shock and/or fire. In this case, contact your local distributor.

- Before setting up this emulator and connecting it to other devices, turn off power or remove a power cable to prevent injury or product damage.

Warnings to Be Taken for This Product:



- Do not disassemble or modify this product. Personal injury due to electric shock may occur if this product is disassembled and modified. Disassembling and modifying the product will void your warranty.

- Make sure nothing falls into the cooling fan on the top panel, especially liquids, metal objects, or anything combustible.

Warning for Installation:



- Do not set this product in water or areas of high humidity. Make sure that the product does not get wet. Spilling water or some other liquid into the product may cause unreparable damage.

Warning for Use Environment:



- This equipment is to be used in an environment with a maximum ambient temperature of 35°C. Care should be taken that this temperature is not exceeded.

 **CAUTION****Notes on Connecting the Power Supply of the Emulator:**

- Do not use any power cable other than the one that is included with the product.
- The power cable included with the product has its positive and negative poles color-coded by red and black, respectively.
- Pay attention to the polarities of the power supply. If its positive and negative poles are connected in reverse, the internal circuit may be broken.
- Do not apply any voltages exceeding the product's rated power supply voltage (5.0 V \pm 5%). Extreme voltages may cause a burn due to abnormal heat or cause the internal circuit to break down.

Cautions to Be Taken for Turning On the Power:

- Turn ON/OFF the power of the emulator and user system as simultaneously as possible.
- Do not leave either the emulator or user system powered on, because of leakage current the internal circuits may be damaged.
- When turning on the power again after shutting off the power, wait about 10 seconds.

Cautions to Be Taken for Handling This Product:

- Use caution when handling the main unit. Be careful not to apply a mechanical shock.
- Do not touch the connector pins of the emulator main unit and the target MCU connector pins directly. Static electricity may damage the internal circuits.
- Do not pull this emulator by the communications interface cable or the cable for connecting the user system. And, excessive flexing or force may break conductors.

Caution to Be Taken for System Malfunctions:

- If the emulator malfunctions because of interference like external noise, do the following to remedy the trouble.
 - (1) Press the RESET button on the emulator upper panel.
 - (2) If normal operation is not restored after step (1), shut OFF the emulator once and then reactivate it.

Contents

	Page
Regulatory Compliance Notices	3
Preface.....	4
Important.....	5
Precautions for Safety	7
User Registration	12
Terminology	13
1. Outline.....	14
1.1 Package Components	14
1.2 System Configuration	15
1.2.1 System Configuration	15
1.2.2 Names and Functions of each part of the Emulator.....	16
1.3 Specifications	19
1.4 Operating Environment.....	20
2. Setup.....	21
2.1 Flowchart of Starting Up the Emulator	21
2.2 Installing the Included Software	22
2.3 Attaching the Ferrite Core	23
2.4 Connecting the Power Supply for the Emulator	23
2.5 Connecting the Host Machine	24
2.6 Turning ON the Power Supply.....	25
2.6.1 MCU Power Supply Source Selection Jumper/MCU Power Supply Voltage Selection Jumper.....	25
2.6.2 Checking Connections of the Emulator System.....	26
2.6.3 Turning ON/OFF the Power	26
2.6.4 Power Supply to the User System	26
2.6.5 LED Display When the Emulator Starts Up Normally	27
2.7 Self-check	29
2.7.1 Self-check Procedure	29
2.7.2 If an Error is Detected in the Self-check.....	30
2.8 Connecting the User System.....	31
2.8.1 Connecting to a 100-pin LCC socket	32
2.8.2 Connecting to a 100-pin 0.65-mm-pitch Foot Pattern (Part 1).....	33
2.8.3 Connecting to a 100-pin 0.65-mm-pitch Foot Pattern (Part 2).....	34
2.8.4 Connecting to a 100-pin 0.65-mm-pitch Foot Pattern (Part 3).....	35
2.8.5 Connecting to a 100-pin 0.5-mm-pitch Foot Pattern (Part 1).....	36
2.8.6 Connecting to a 100-pin 0.5-mm-pitch Foot Pattern (Part 2).....	37
2.8.7 Connecting to a 100-pin 0.5-mm-pitch Foot Pattern (Part 3).....	38
2.8.8 Connecting to a 144-pin 0.5-mm-pitch Foot Pattern	39
2.9 Changing Settings	40
2.9.1 Setting Switches of Emulator	40
2.9.2 Selecting Clock Supply	47
2.9.3 A/D Conversion Bypass Capacitors	51
3. Usage (Emulator Debugger).....	53
3.1 Starting Up the Emulator Debugger (Init Dialog Box)	53
3.2 Starting Up the Emulator Debugger (EMEM Dialog Box)	59
3.3 Program Window	63
3.4 Hardware Breakpoint Setting Window.....	67
3.5 Trace Window.....	72
3.6 RAM Monitor Window.....	77

	Page
4. Hardware Specifications	80
4.1 Target MCU Specifications.....	80
4.2 Differences between the Actual MCU and Emulator.....	81
Notes on the User System (Power Supply, Order of Powering On):	81
Notes on Using This Product When the Voltage of VCC1 is Higher than That of VCC2:.....	81
Note on Intelligent I/O Resistor Access:.....	81
Note on Differences between the Actual MCU and Emulator:.....	82
Note on RESET* Input:	82
Note on RDY* Input:.....	82
Note on HOLD* Input:	82
Note on NMI* Input:.....	82
Notes on Reset Vector Area:	83
Notes on Stack Area:	83
Notes on Maskable Interrupts:	83
Notes on Access Prohibited Area:	83
Note on DMA Transfer:	83
Note on DMAC II Transfer Completion Interrupts:	83
Note on Final Evaluation:	83
4.3 Connection Diagram.....	84
4.4 External Dimensions.....	87
4.4.1 External Dimensions of the Compact Emulator	87
4.4.2 External Dimensions of the M30800T-PTC	88
4.4.3 External Dimensions of the M3T-F160-100NSD.....	89
4.4.4 External Dimensions of the M3T-FLX-144NSD	89
4.5 Notes on Using This Product.....	90
Notes on the Self-check:	90
Note on Quitting the Emulator Debugger:.....	90
Notes on Clock Supply to the MCU:.....	90
Notes on Using the CPU Clock at Less than 10 MHz:.....	90
Notes on Address-Match Interrupts:	90
Notes on EMEM Dialog Box:.....	91
Notes on the Watchdog Function:.....	91
Notes on Debugging in CPU Rewrite Mode:.....	91
Note on Software Breaks:	92
Notes on Service-Life of the MCU's Internal Flash ROM:.....	92
Note on Voltage Detect Circuit:.....	92
Note on Protect Register:.....	92
Note on Memory Access:	92
Notes on A/D Conversion:.....	93
Notes on MCU File:	94
Notes on CE Declaration of Conformity:	94
5. Troubleshooting	95
5.1 Flowchart to Remedy the Troubles	95
5.2 When the Emulator Debugger Does Not Start Up Properly	96
5.3 How to Request for Support	99
6. Maintenance and Guarantee	100
6.1 User Registration.....	100
6.2 Maintenance	100
6.3 Guarantee.....	100
6.4 Repair Provisions	100
6.5 How to Make Request for Repair	101

User Registration

When you install debugger software, a text file for user registration is created on your PC. Fill it in and email it to your local distributor. If you have replaced an emulator main unit or emulation probe, rewrite an emulator name and serial number in the text file you filled in earlier to register your new hardware products.

Your registered information is used for only after-sale services, and not for any other purposes. Without user registration, you will not be able to receive maintenance services such as a notification of field changes or trouble information. So be sure to carry out the user registration.

For more information about user registration, please contact your local distributor.

Terminology

Some specific words used in this user's manual are defined as follows:

Emulator M30870T2-CPE

This means the compact emulator (this product) for M32C/87 Group MCUs.

MCU board M30870T-EPBM

The MCU board M30870T-EPBM with an evaluation MCU.

Emulator system

This means an emulator system built around the M30870T2-CPE emulator. The M30870T2-CPE emulator system is configured with an emulator main unit M30870T2-CPE, M32C compact emulator debugger and host machine.

M32C compact emulator debugger

This means a software tool which you can control the emulator from a host machine through the USB interface.

Firmware

This means a program stored in the flash ROM of the emulator. It analyzes contents of communication with the emulator debugger and controls the emulator M30870T2-CPE. This program is downloadable from the emulator debugger to upgrade firmware or to support other MCUs.

Host machine

This means a personal computer used to control the M30870T2-CPE emulator system.

Software break

A software break is a function to break the program before the system executes an instruction at the specified address. The instruction at the preset address will not be executed.

Hardware break

A hardware break is a function to break the program when the system detects a write/read of data to/from memory or a leading/trailing edge of the signal entered from the external trace cable. The former break function is called address break; and the latter break function is called trigger break. While the instruction at the address where the software break is set is not executed, a hardware break is performed after the specified instruction is executed.

Target MCU

This means the microcomputer you are going to debug.

User system

This means a user's application system using the microcomputer to be debugged.

User program

This means a user's application program to be debugged.

Evaluation MCU

This means a microcomputer mounted on the emulator which is operated in the special mode for the emulator.

*

In this user's manual, this symbol is used to show active LOW. (e.g. RESET*)

1. Outline

This chapter describes the package components, the system configuration and the preparation for using this product for the first time.

1.1 Package Components

The M30870T2-CPE package consists of the following items. When unpacking it, check to see if your M30870T2-CPE contains all of these items.

Table 1.1 Package components

Item	Quantity
M30870T2-CPE compact emulator	1
M30800T-PTC (pre-mounted) converter board for 100-pin LCC socket	1
IC61-1004-051 100-pin LCC socket made by Yamaichi Electronics Co, Ltd.	1
OSC-3 (32MHz) oscillator circuit board	1
OSC-2 oscillator circuit bare board	1
USB interface cable for connecting host machine and emulator	1
Power supply cable for compact emulator	1
Ferrite core for connecting power supply cable	1
H/W Tool Customer Registration Sheet (English)	1
H/W Tool Customer Registration Sheet (Japanese)	1
M30870T2-CPE User's Manual (this manual)	1
M30870T2-CPE User's Manual (Japanese)	1
M30870T2-CPE Release Notes (English)	1
M30870T2-CPE Release Notes (Japanese)	1
CD-ROM - M32C compact emulator debugger - C compiler M3T-NC308WA (evaluation version)	1

* Please keep the M30870T2-CPE's packing box and cushion material in your place for reuse at a later time when sending your product for repair or other purposes. Always use these packing box and cushion material when transporting this product.

* If there is any question or doubt about the packaged product, contact your local distributor.

1.2 System Configuration

1.2.1 System Configuration

Figure 1.1 shows a configuration of the M30870T2-CPE system.

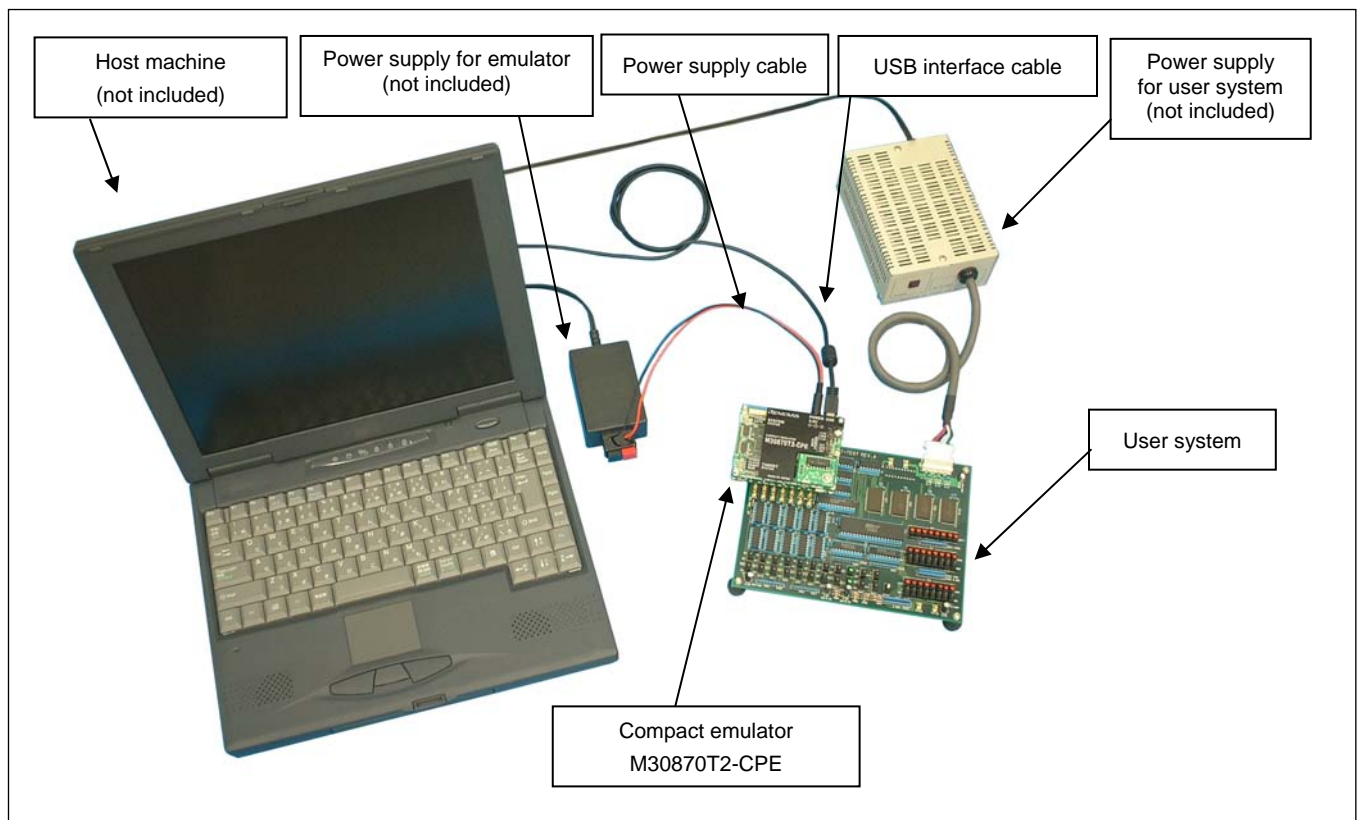


Figure 1.1 System configuration

- (1) Compact emulator M30870T2-CPE (this product)
This is a compact emulator for the M32C/87 Group with the real-time trace functions (hereafter, emulator).
- (2) USB interface cable (included)
This is an interface cable for the host machine and the emulator.
- (3) Power supply for emulator
This is a power supply for the emulator. Supply 5.0 V \pm 5% (DC).
Prepare a power supply which complies with CE marking requirements separately. The power cable is included with this product.
Note: Be aware that there are some AC adapters whose power supply voltage varies rather widely with its load. You are recommended to use an AC adapter with a switching power supply or a stabilized power supply.
- (4) User system
This is your application system. This emulator can be used without the user system.

(5) Power supply for the user system

This is a power supply for the user system. As this emulator cannot supply the power to the user system, supply the power to the user system separately from the emulator.

(6) Host machine

This is a personal computer for controlling the emulator.

(7) Pitch converter board such as M30800T-PTC (included)

This is a pitch converter board for connecting to an MCU foot pattern on the user system (for 100-pin 0.65-mm-pitch LCC socket). For details, refer to “2.8 Connecting the User System” (page 31).

1.2.2 Names and Functions of each part of the Emulator

Figure 1.2 shows the names of the LEDs on the upper panel of the emulator.

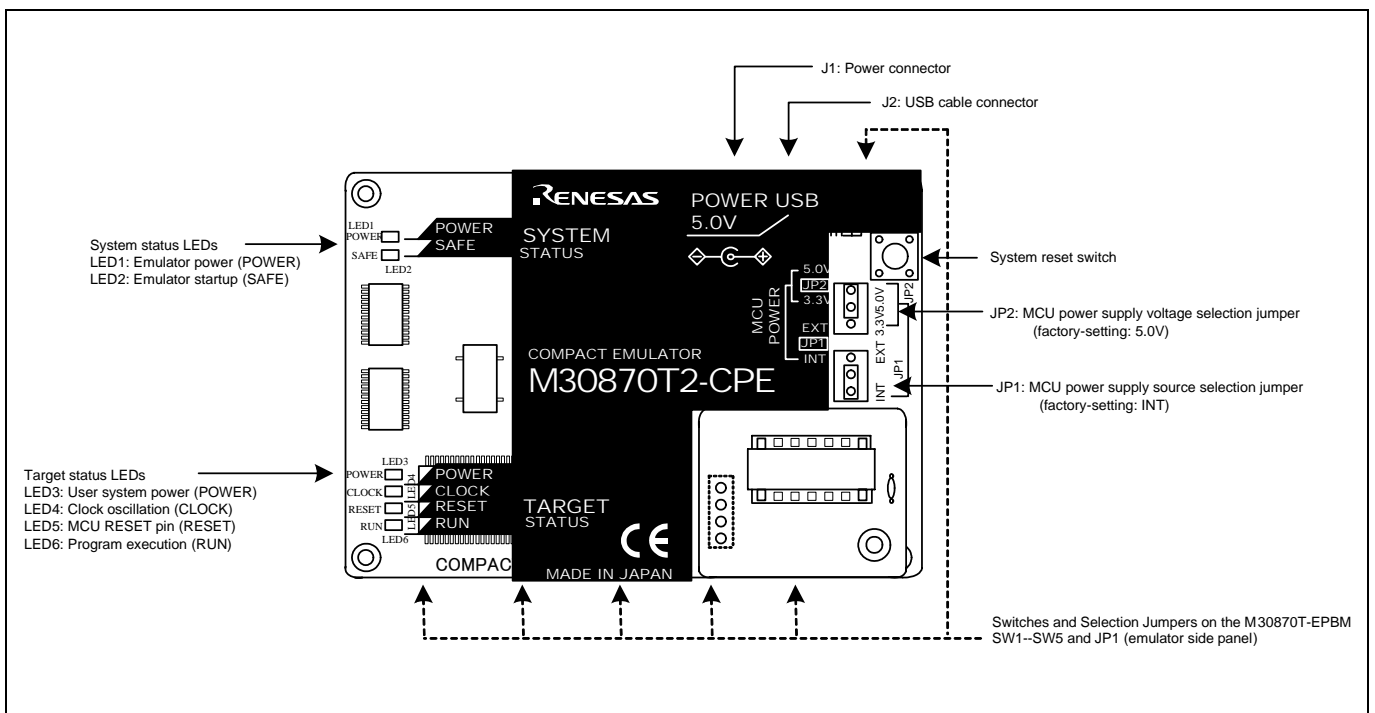


Figure 1.2 Names of the LEDs on the upper panel of the M30870T2-CPE

(1) System Status LEDs

The system status LEDs indicate the emulator main unit's operating status etc. Table 1.2 lists the definition of the system status LEDs.

Table 1.2 Definitions of the system status LEDs

Name	Number	Color	Status	Meaning
POWER	LED1	Orange	ON	Power is supplied to the emulator.
			OFF	Power is not supplied to the emulator.
SAFE	LED2	Green	ON	Emulator system has started normally.
			OFF	Emulator system has not started normally.

(2) Target Status LEDs

The target status LEDs indicate the target MCU's power supply and operating status. Table 1.3 lists the definition of each target status LED.

Table 1.3 Definitions of the target status LEDs

Name	Number	Color	Status	Meaning
POWER	LED3	Orange	ON	Power is supplied to the target MCU.
			OFF	Power is not supplied to the target MCU.
CLOCK	LED4	Green	ON	The target MCU internal clock is oscillating.
			OFF	The target MCU internal clock is not oscillating.
RESET	LED5	Red	ON	Target MCU is being reset.
			OFF	Target MCU is not being reset.
RUN	LED6	Green	ON	User program is being executed.
			OFF	User program is not being executed.

(3) System Reset Switch

By pressing the system reset switch, you can initialize the emulator system. Table 1.4 shows the functions of the system reset switch depending on the state of the emulator.

Table 1.4 Functions of the system reset switch

State of Emulator	Function
When the user's program is halted	Initializes the emulator and waits for a command from the emulator debugger
When the user's program is executed	Stops the user's program, initializes the emulator, and waits for a command from the emulator debugger.

IMPORTANT

Notes on a System Reset:

- After pressing the system reset switch, restart the emulator debugger. Otherwise the display of emulator debugger and the actual value (in the emulator) may not match.
- When the emulator debugger does not start up normally even after rebooting, turn off the emulator and then turn on again.

(4) Power Connector (J1)

This is a connector for connecting the power supply to this product. For details, refer to "2.4 Connecting the Power Supply for the Emulator" (page 23).

(5) USB Cable Connector (J2)

This is a USB cable connector for connecting the host machine to this product. For details, "2.5 Connecting the Host Machine" (page 24).

(6) MCU Power Supply Source Selection Jumper (JP1)

This is a jumper switch to set the power supply source to the MCU. For details on this switch, see “2.6.1 MCU Power Supply Source Selection Jumper/MCU Power Supply Voltage Selection Jumper” (page 25).

(7) MCU Power Supply Voltage Selection Jumper (JP2)

This is a jumper switch to set the power supply voltage of the MCU. This setting is valid when the MCU power supply source selection jumper is set to INT only. For details on this switch, see “2.6.1 MCU Power Supply Source Selection Jumper/MCU Power Supply Voltage Selection Jumper” (page 25).

(8) Switches and Selection Jumpers on the M30870T-EPBM

These are switches to change the connections in the emulator according to the user system. For details on the settings, see “2.9 Changing Settings” (page 40).

1.3 Specifications

Table 1.5 and 1.6 list specifications of the M30870T2-CPE.

Table 1.5 M30870T2-CPE specifications (1/2)

Applicable MCUs	M32C/87 Group	
Evaluation MCU	M3087BFLGP ROM size: 1024 KB + 4 KB, RAM size: 48 KB	
Usable mode	Single-chip mode Memory expansion mode	
Maximum operating frequency*	VCC1=VCC2=4.2--5.5V: 32MHz VCC1=VCC2=3.0--5.5V: 24MHz Dual-power supply specification (4.8 V ≤ VCC1 ≤ 5.5 V and 3.0 V ≤ VCC2 < VCC1): 24MHz	
Applicable power supply	User system connected (JP1=EXT)	3.0--5.5 V
	User system not connected (JP1=INT)	3.3 V or 5.0 V (supplied from the emulator, set by JP2)
Basic debugging functions	<ul style="list-style-type: none"> - Download - Software break (max. 64 points) - Program execution/stop (allows free-run execution supporting software breaks) - Memory reference/setting (reference/setting C-variables, run-time execution) - Register reference/setting - Disassemble display - C-level debugging, etc. 	
Real-time trace function	<ul style="list-style-type: none"> - 64K-cycle bus information recordable (Address: 24 bits, Data: 16 bits, MCU status: 12 bits) - 5 trace modes supported (Break/Before/About/After/Full) - Can be recorded ON/OFF by events 	
Real-time RAM monitor function	<ul style="list-style-type: none"> - 1,024 bytes (256 bytes x4) - Data/last access result 	
Hardware break function	2 points (Address match, bus match, max. 255 pass counts)	
Execution time measurement function	Time between program start and stop	

* Notes on Using This Product

- If using this product when the voltage of VCC1 is higher than that of VCC2, the CPU clock must be 24MHz or less.
- If using a CPU clock of more than 24MHz, set the SFR area of the intelligent I/O function to 2-wait (set the PM13 bit to "1") when reading this area.

These precautions only need to be observed when using an emulator, and does not apply for the actual MCU.

Table 1.6 M30870T2-CPE specifications (2/2)

Connection to user system (see “2.8 Connecting the User System” on page 31)	For 144-pin 0.5-mm-pitch LQFP (144P6Q-A)	M3T-FLX-144NSD (not included)
	For 100-pin 0.5-mm-pitch LQFP (100P6Q-A)	(1) M30800T-PTC (included) + M3T-100LCC-QSD (not included) (2) M30800T-PTC (included) + M3T-100LCC-DMS (not included) + M3T-FLX-100NSD (not included) (3) M3T-F160-100NSD (not included)
	For 100-pin 0.65-mm-pitch QFP (100P6S-A):	(1) M30800T-PTC (included) + M3T-100LCC-DMS (not included) + M3T-FLX-100NRB (not included) (2) M30800T-PTC (included) + M3T-100LCC-DMS (not included) + M3T-DUMMY100S (not included) (3) M30800T-PTC (included) + M3T-100LCC-DMS (not included) + M3T-DIRECT100S (not included)
	100-pin LCC socket	M30800T-PTC (included) + IC61-1004-051 (included)
Power supply for emulator	DC 5.0 V \pm 5 % / (2 A) externally supplied (Prepare a power supply which complies with CE marking requirements separately.)	
Host machine interface	USB (USB 1.1 full-speed*, mini-B standard connector)	

* Available to connect the host machine that supports USB 2.0. With the USB interface, not all hardware (such as host machine, USB devices, USB hub) combination will work and guaranteed.

1.4 Operating Environment

Be sure to use this emulator with the operating environmental of the emulator and host machine listed in Tables 1.7 and 1.8.

Table 1.7 Operating environmental conditions

Item	Description
Operating temperature	5 to 35°C (no dew)
Storage temperature	-10 to 60°C (no dew)

Table 1.8 Operating environment of the host machine

Item	Description
Host machine	IBM PC/AT compatibles
OS	Windows® XP ^{*1} Windows® 2000
CPU	Pentium III 600 MHz or more recommended
Host machine interface	USB 1.1 full-speed ^{*2}
Memory	128 MB or more recommended
Pointing device such as mouse	Mouse or any other pointing device usable with the above OS that can be connected to the main body of the host machine.
CD drive	Needed to install the emulator debugger or refer to the user's manual

*1 Windows is either a registered trademark or trademark of Microsoft Corporation in the United States and/or other countries.

*2 Available to connect the host machine that supports USB 2.0. With the USB interface, not all hardware (such as host machine, USB devices, USB hub) combination will work and guaranteed.

2. Setup

This chapter describes the preparation for using this product, the procedure for starting up the emulator and how to change settings.

2.1 Flowchart of Starting Up the Emulator

The procedure for starting up the emulator is shown in Figure 2.1. For details, refer to each section hereafter. And, when the emulator does not start up normally, refer to “5. Troubleshooting” (page 95).

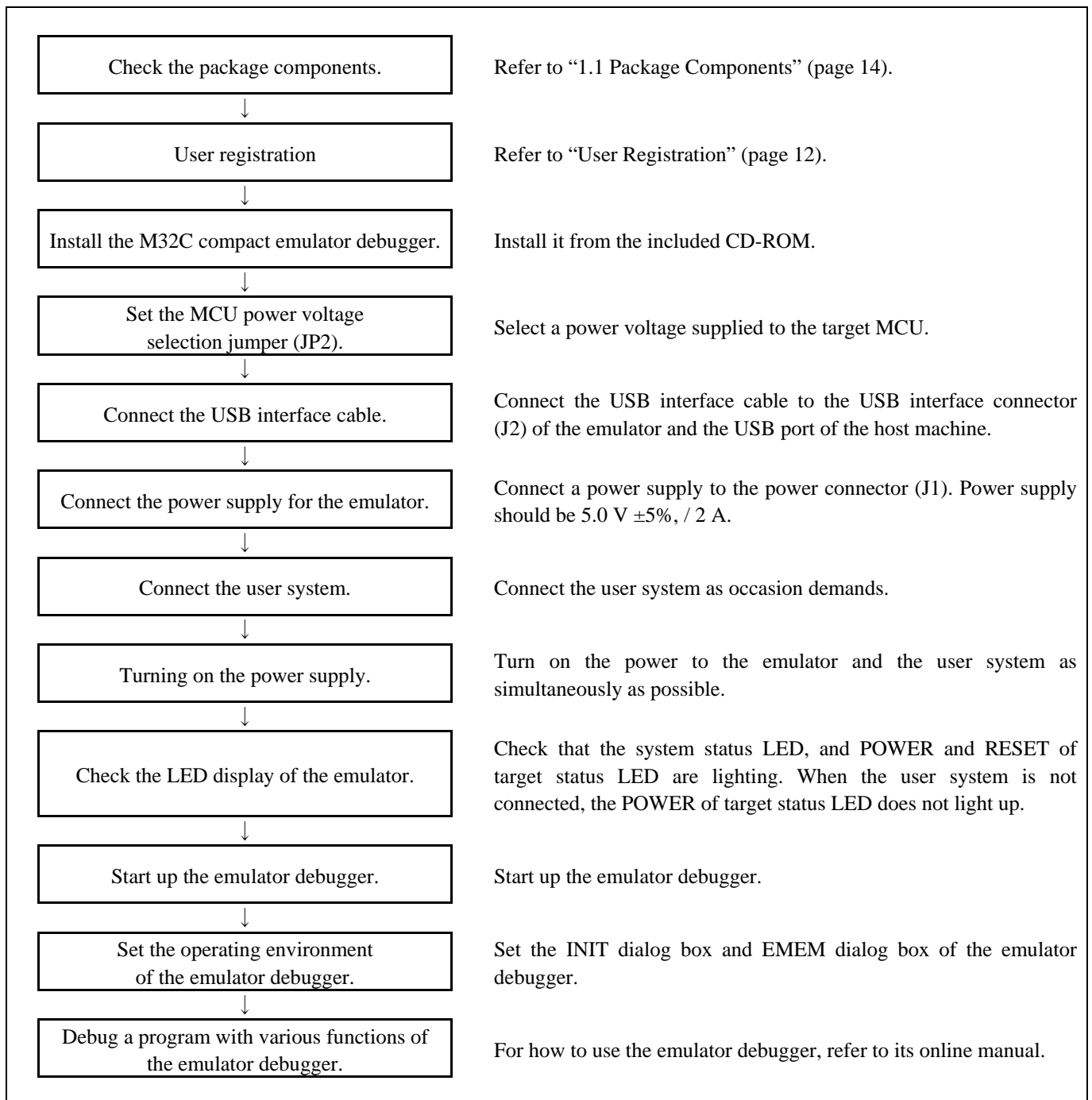


Figure 2.1 Flowchart of starting up the emulator

2.2 Installing the Included Software

If the OS used in your host machine is Windows® XP or Windows® 2000, this installation must be executed by a user with administrator rights. Be aware that users without administrator rights cannot complete the installation.

The "auto_run.exe" starts up by inserting the included CD into the CD-ROM drive, and the HTML page for installation will open. Install the C compiler, emulator debugger and USB driver as occasion demands.

In process of installation, "user information" dialog box to enter the user information (contractor, section, contact address, and host machine) will open. The supplied information will be turned into a format by which technical support will be provided by e-mail.

2.3 Attaching the Ferrite Core

Attach the ferrite core included with this product close to the DC plug of the power cable. Without the ferrite core it may cause interference.

The power cable should be wound around the ferrite core as shown in the figure, and close the ferrite core until it clicks.

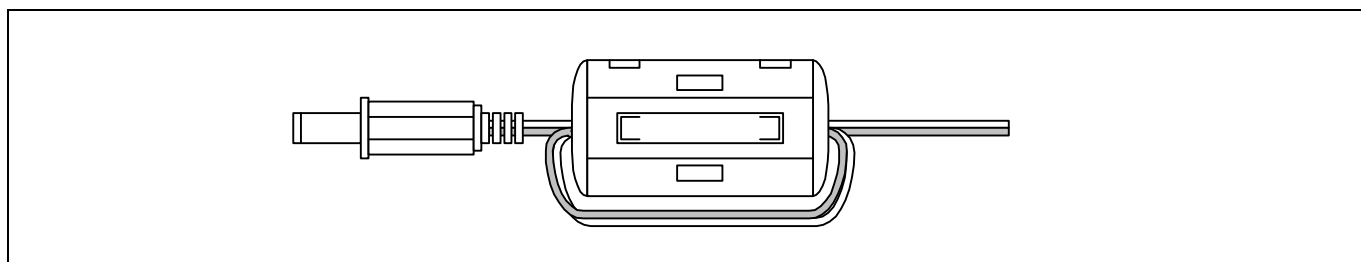


Figure 2.2 Attaching the ferrite core

2.4 Connecting the Power Supply for the Emulator

Connect the power supply for the emulator to the power connector (J1). The specification of the power supply for the emulator is listed in Table 2.1.

Table 2.1 Specification of power supply of the emulator

Power supply voltage	DC 5.0 V \pm 5%/2 A
----------------------	-----------------------

Figures 2.3 and 2.4 show the specifications of the power connector (J1) and an applicable plug, respectively.

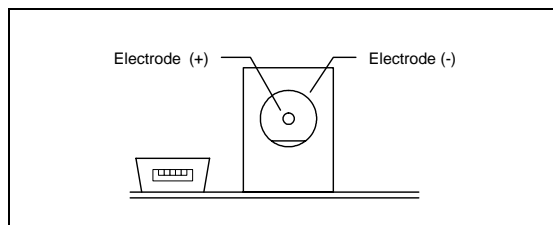


Figure 2.3 Power connector specifications

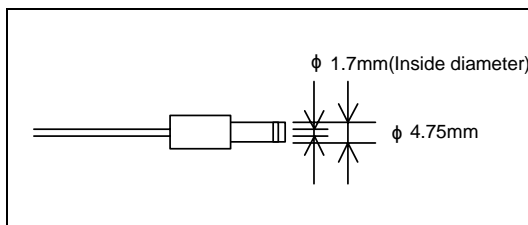


Figure 2.4 Applicable plug specifications

⚠ CAUTION

Notes on Connecting a Power Supply of the Emulator:



- The power cable included in this product package is colored red (+) and black (-).
- Be careful about the polarity of the power supply. Connecting to the wrong electrode could destroy internal circuits.
- Do not apply a voltage exceeding the specified voltage of the product (5.0 V \pm 5%), because it may cause burn injuries and the failure of internal circuits.
- Use the power supply which complies with CE marking requirements.

2.5 Connecting the Host Machine

Connect the emulator and the host machine with the USB interface cable.

Connect the USB interface cable (included) to the USB interface connector (J2) and the USB port of the host machine (see Figure 2.5).

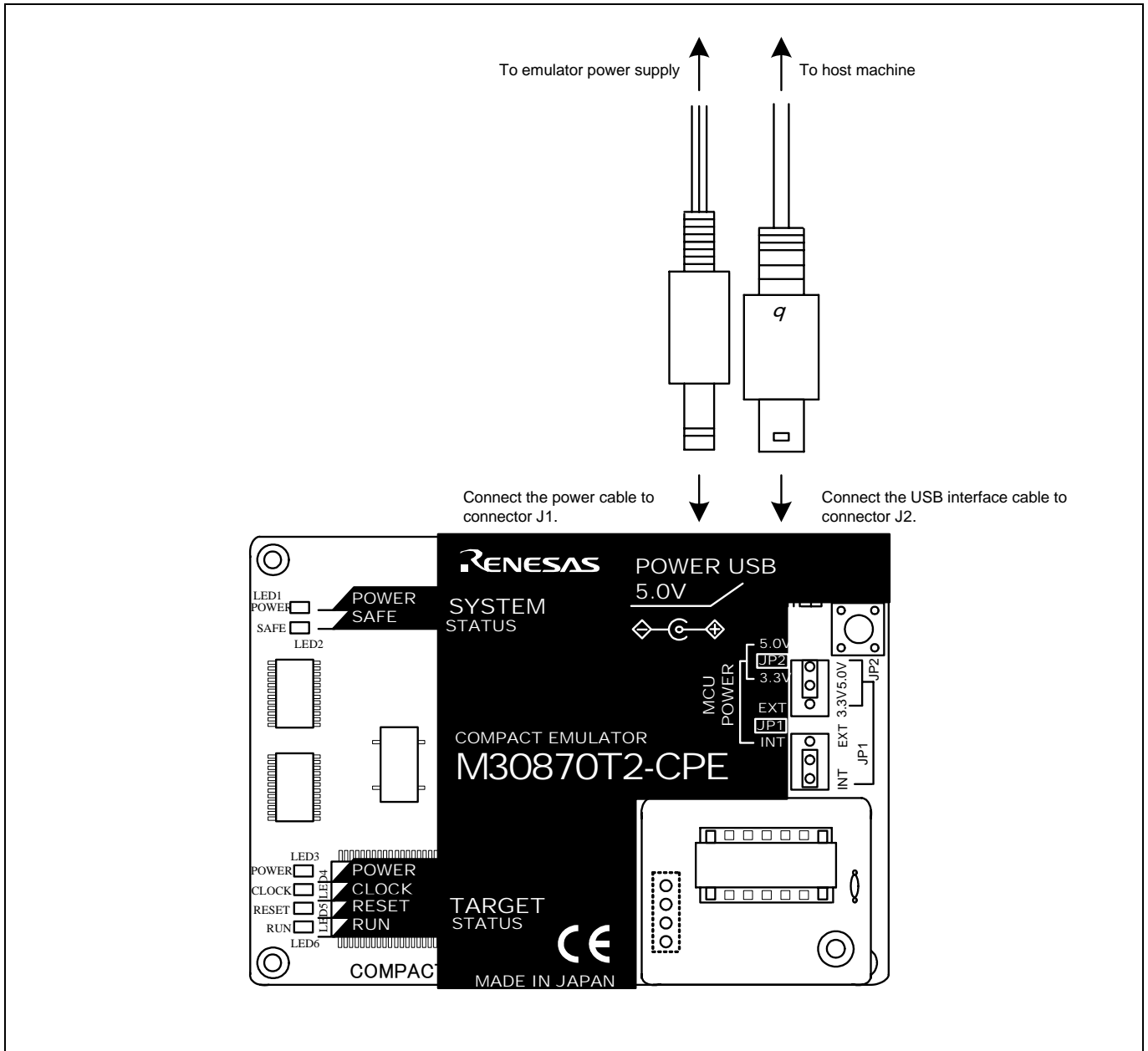


Figure 2.5 Connecting the emulator system

2.6 Turning ON the Power Supply

2.6.1 MCU Power Supply Source Selection Jumper/MCU Power Supply Voltage Selection Jumper

Set the MCU power supply source selection jumper and the MCU power supply voltage selection jumper of the emulator according to conditions of use.

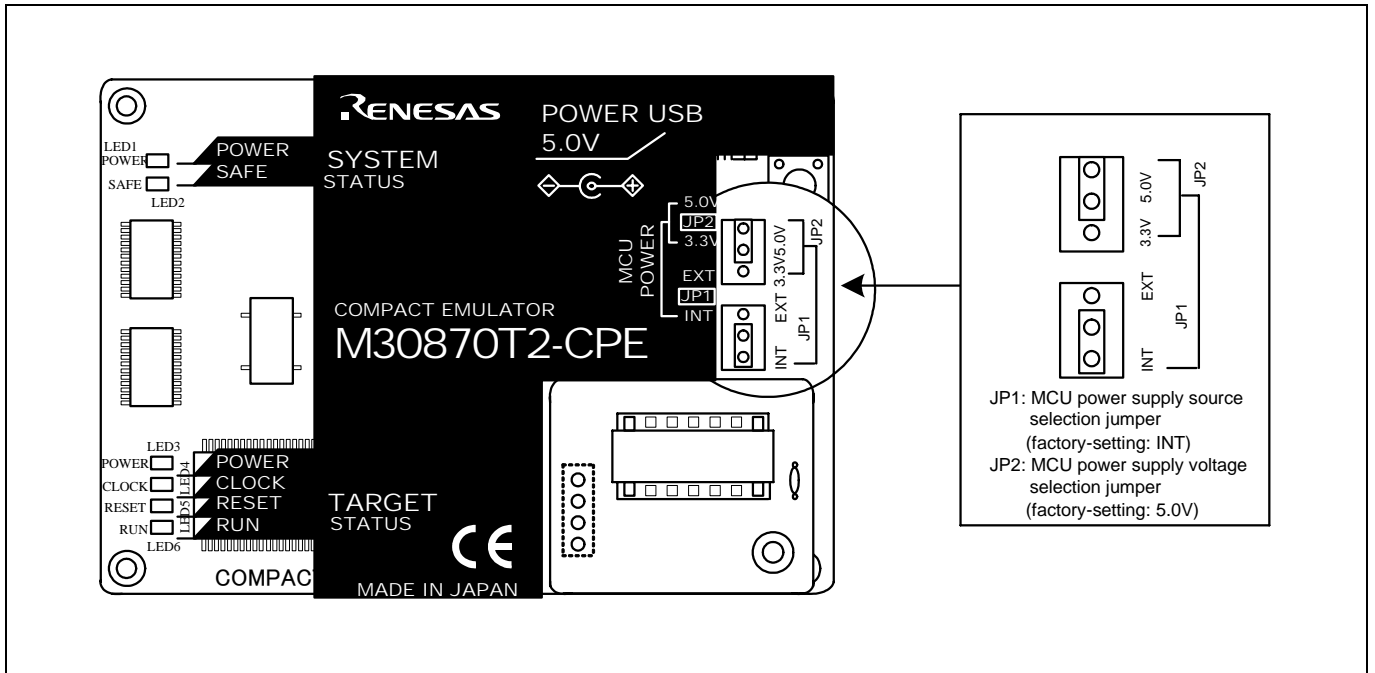


Figure 2.6 Jumper switch locations

These are the jumper switches to select power supply to the MCU and its power voltage. As shown in Table 2.2 below, set the switch according to the connection to the user system.

Table 2.2 Setting jumper switches

Connection to the user system	MCU power supply source selection jumper (JP1)	MCU power supply voltage selection jumper (JP2)	Description
Not connected	INT	3.3 V	Supplied from the emulator. The MCU operating voltage is 3.3 V.
		5.0 V	Supplied from the emulator. The MCU operating voltage is 5.0 V.
Connected	EXT	Invalid	Supplied from the user system. This emulator consumes max. 500 mA of electrical current from the user system.

⚠ CAUTION

Note on Jumper Switch Settings:



- Always shut OFF the emulator before changing the setting of the jumper switches, and connecting the cable. Otherwise the internal circuit may cause a break.

2.6.2 Checking Connections of the Emulator System

Before turning the power ON, check the connection of the interface cable to the host machine, emulator, and user system.

2.6.3 Turning ON/OFF the Power

Turn ON/OFF the power of the emulator and user system as simultaneously as possible.

Do not leave either the emulator or user system powered on, because of leakage current the internal circuits may be damaged.

When turning ON the power again after shutting OFF the power, wait for about 10 seconds.

2.6.4 Power Supply to the User System

This emulator cannot supply the power to the user system. Therefore design your system so that the user system is powered separately. This product consumes max. 500mA of electrical current from the user system. Please consider the capacity of the power supply of the user system.

The voltage of the user system should be within the following. And do not change the voltage of the user system after turning on the power.

(1) When JP1 of the M30870T-EPBM is set as VCC1=2:

$$3.0 \text{ V} \leq \text{VCC1} = \text{VCC2} \leq 5.5 \text{ V}$$

(2) When JP1 of the M30870T-EPBM is set as VCC1 > 2:

$$4.8 \text{ V} \leq \text{VCC1} \leq 5.2 \text{ V}$$

$$3.0 \text{ V} \leq \text{VCC2} < \text{VCC1}$$

2.6.5 LED Display When the Emulator Starts Up Normally

After the emulator starts up, check the status of the LEDs to see whether the emulator operation is enabled or not. Figure 2.7 shows the positions of the emulator status LEDs.

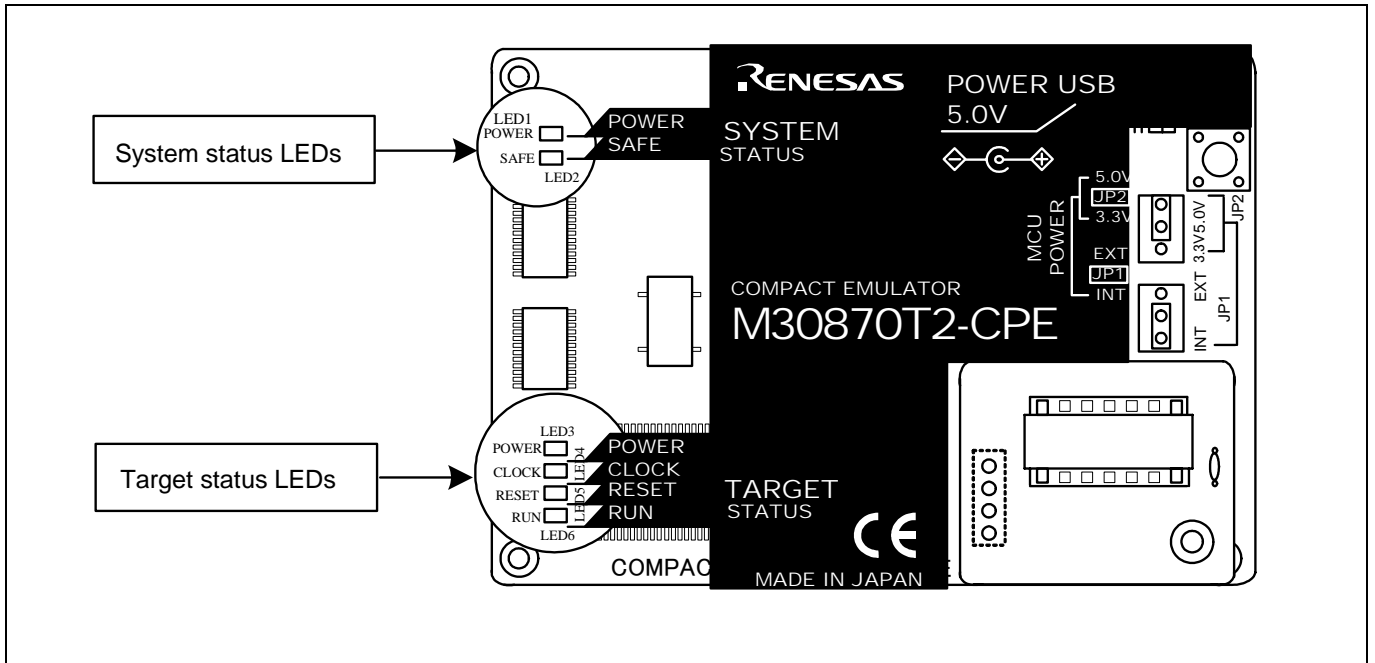


Figure 2.7 Positions of the system status LEDs and target status LEDs

(1) System status LEDs

Check that the LED1 and LED2 of the system status LEDs are lit immediately after the power is activated. If it is not lit, shut off the emulator and check the power supply for the emulator is properly connected.

(2) Target status LEDs

Target status LEDs light as shown in Figure 2.8 when the user system is not connected and as shown in Figure 2.9 when a user system is connected. **After turning on the power, only the LED5 (RESET) lights on. Check the target status LEDs display normally after starting up the emulator debugger.**

When the target status LEDs do not display as shown in Figures 2.8 and 2.9, refer to “5. Troubleshooting” (page 95).

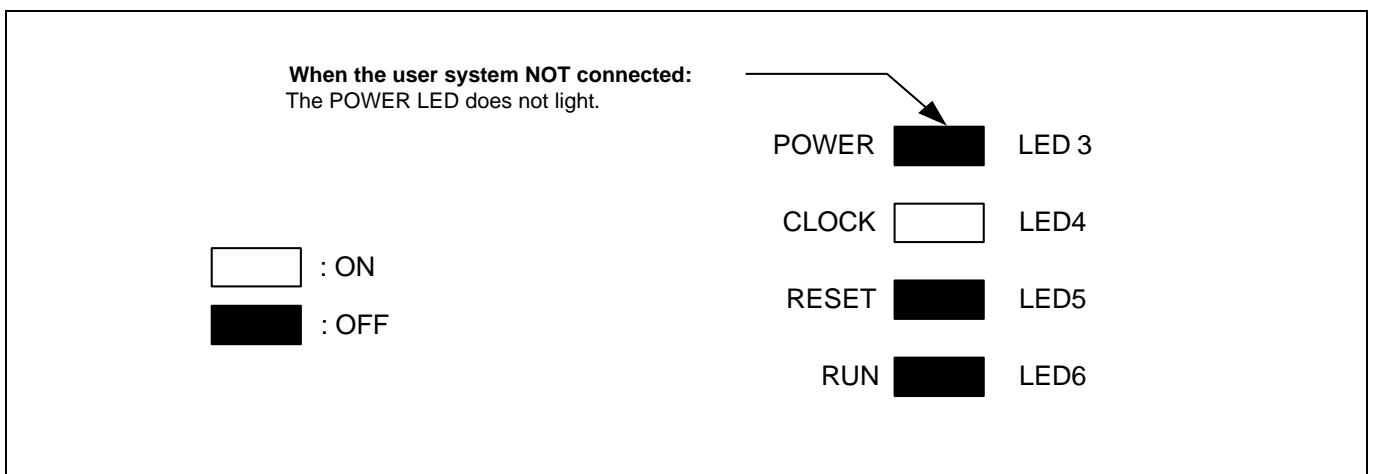


Figure 2.8 Target status LEDs display when the emulator starts up normally (when user system not connected)

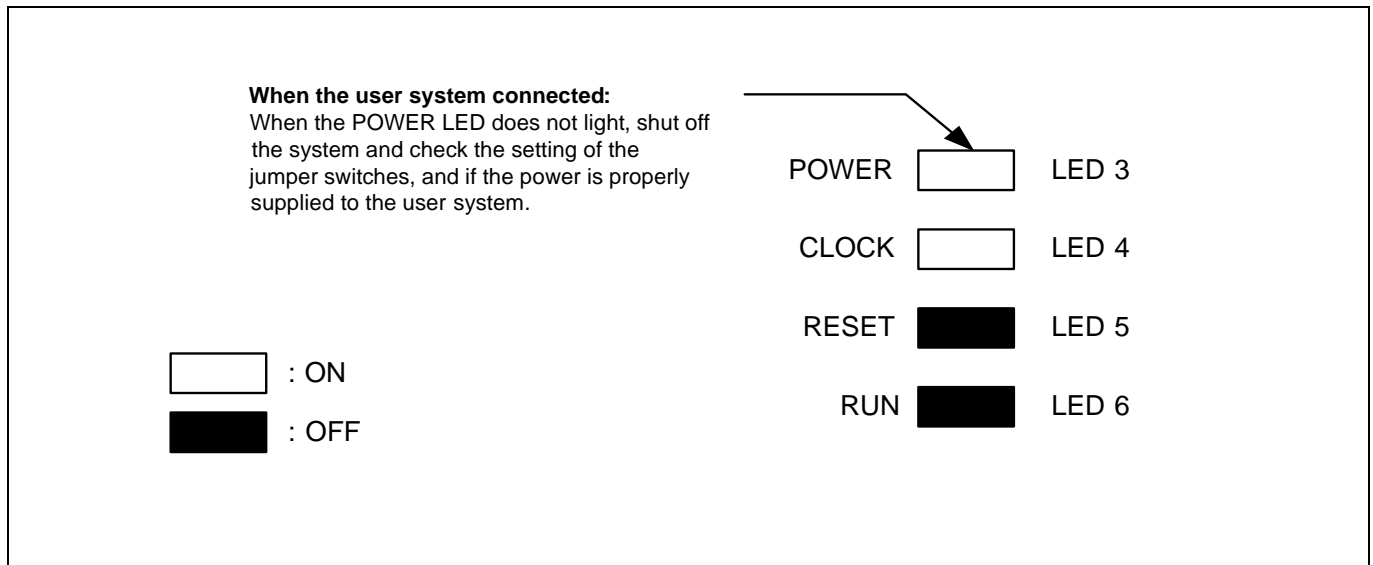


Figure 2.9 Target status LEDs display when the emulator starts up normally (when user system connected)

IMPORTANT

Note on the Target Status CLOCK LED:

- If the LED is not turned on, check the following.
 - (1) After powering on the emulator (before starting up the emulator debugger):
Make sure that the oscillator circuit board is properly installed in the emulator and it is oscillating normally.
 - (2) After the emulator debugger is started up (after the Init dialog box settings are completed):
Make sure that the oscillator selected in the Init dialog box is oscillating normally.

2.7 Self-check

2.7.1 Self-check Procedure

To run the self-check of the emulator, do so as explained here below. While the self-check is in progress, the LEDs will change as shown in Figure 2.10.

- (1) If the user system is connected, disconnect it.
- (2) Set the switches as the factory-settings to execute the self-check (see Table 2.3).
- (3) Within 2 seconds of activating power to the emulator, press the system reset switch on the emulator upper panel.
- (4) Check the SAFE LED starts flashing and then press the system reset switch again.
- (5) The self-check will start. If the normal result is displayed in about 10 seconds, the self-check terminated normally.

Table 2.3 Switch settings for the self-check

Switch	Setting
MCU power supply source selection jumper (JP1)	INT
MCU power supply voltage selection jumper (JP2)	5V

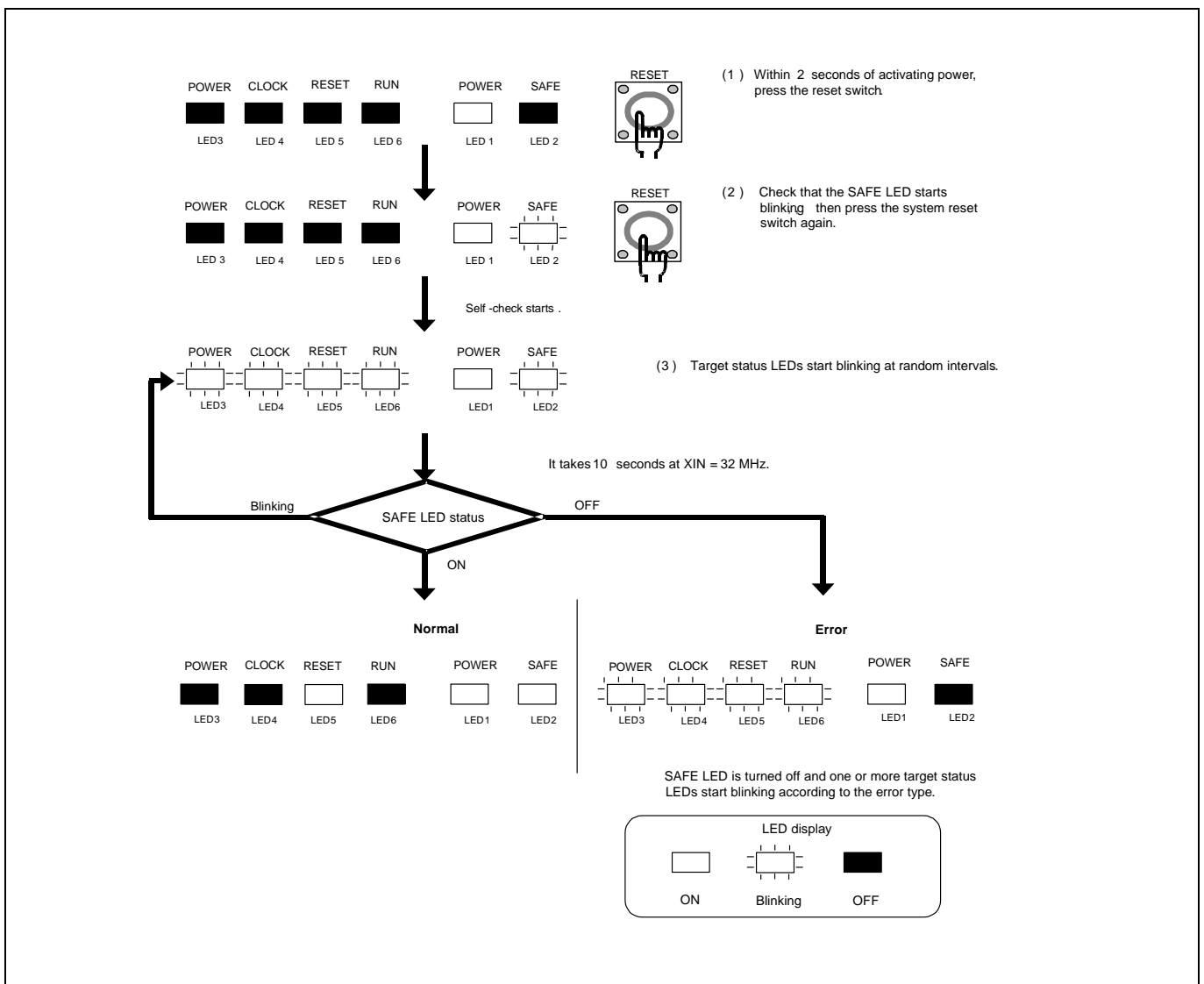














































































Figure 2.10 LED display during the self-check

2.7.2 If an Error is Detected in the Self-check

Table 2.4 lists how to remedy the troubles if the target status LED display is abnormal in the self-check. When an error is detected, shut off the emulator and the user system and follow the steps in the Table 2.4.

Table 2.4 Error display in the self-check and how to remedy it

LED display				Problem & Remedy
POWER	CLOCK	RESET	RUN	
				The emulator system is not working properly. - Check that power is supplied to the emulator. - The emulator may be damaged. Contact your local distributor.
				
				A clock is not supplied to the emulator. - Check that the oscillator circuit board (OSC-3) is attached.
				
				The power is not supplied to the emulator. - Check that the power supply cable is connected properly. - Check of jumper switch settings (see Table 2.3).
				
				The block 0 area (address FFF000h--FFFFFFh) may be rewritten when debugging in the CPU rewrite mode. - Within 2 seconds of activating power to the emulator, press the system reset switch to restart the emulator debugger. The firmware will be redownloaded.
				
				The emulator system is not working properly. - The emulator may be damaged. Contact your local distributor.
				
				
				
				
				
				
				
				
				
				

IMPORTANT

Notes on the Self-check:

- **Be sure to disconnect the user system** before executing the self-check.
Use the preinstalled oscillator circuit board OSC-3 (32 MHz) to execute the self-check.
- If the self-check does not result normally (excluding target status errors), the emulator may be damaged. Then, contact your local distributor.

2.8 Connecting the User System

Figure 2.11 shows the connection of the M30870T2-CPE and the user system.

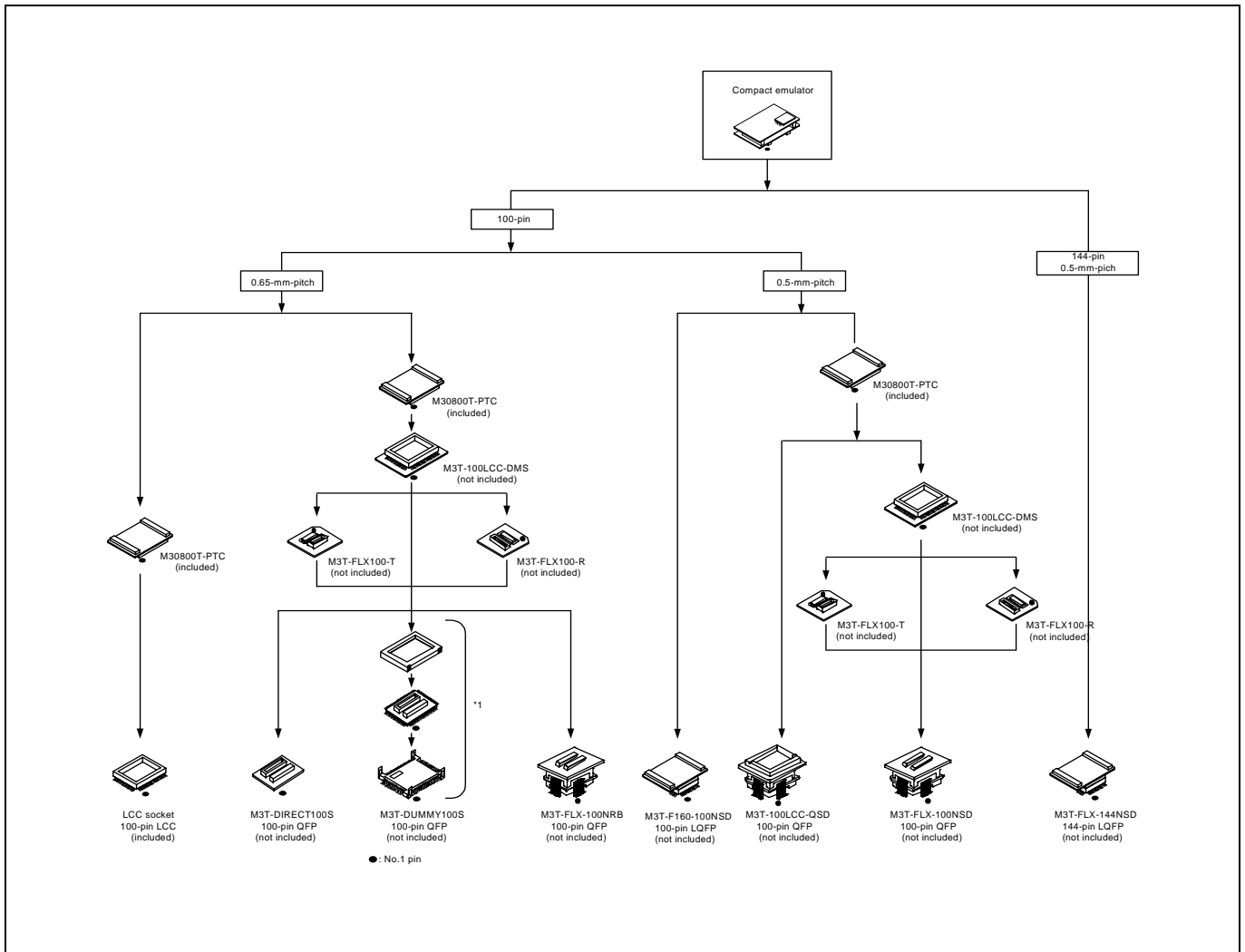


Figure 2.11 Connection of the M30870T2-CPE and user system

CAUTION

Note on Connecting the User System:



- Take care not to attach the converter board in a wrong direction. It may cause a fatal damage to the emulator and user system.

2.8.1 Connecting to a 100-pin LCC socket

Here following is a procedure of connecting to a 100-pin LCC socket (Yamaichi Electronics Co., Ltd.:IC61-1004-051, etc.) on the user system.

- (1) Attach the CN2 side of the M30870T2-CPE to the CN2 side of the M30800T-PTC.
- (2) Attach the M30800T-PTC to the 100-pin LCC socket.

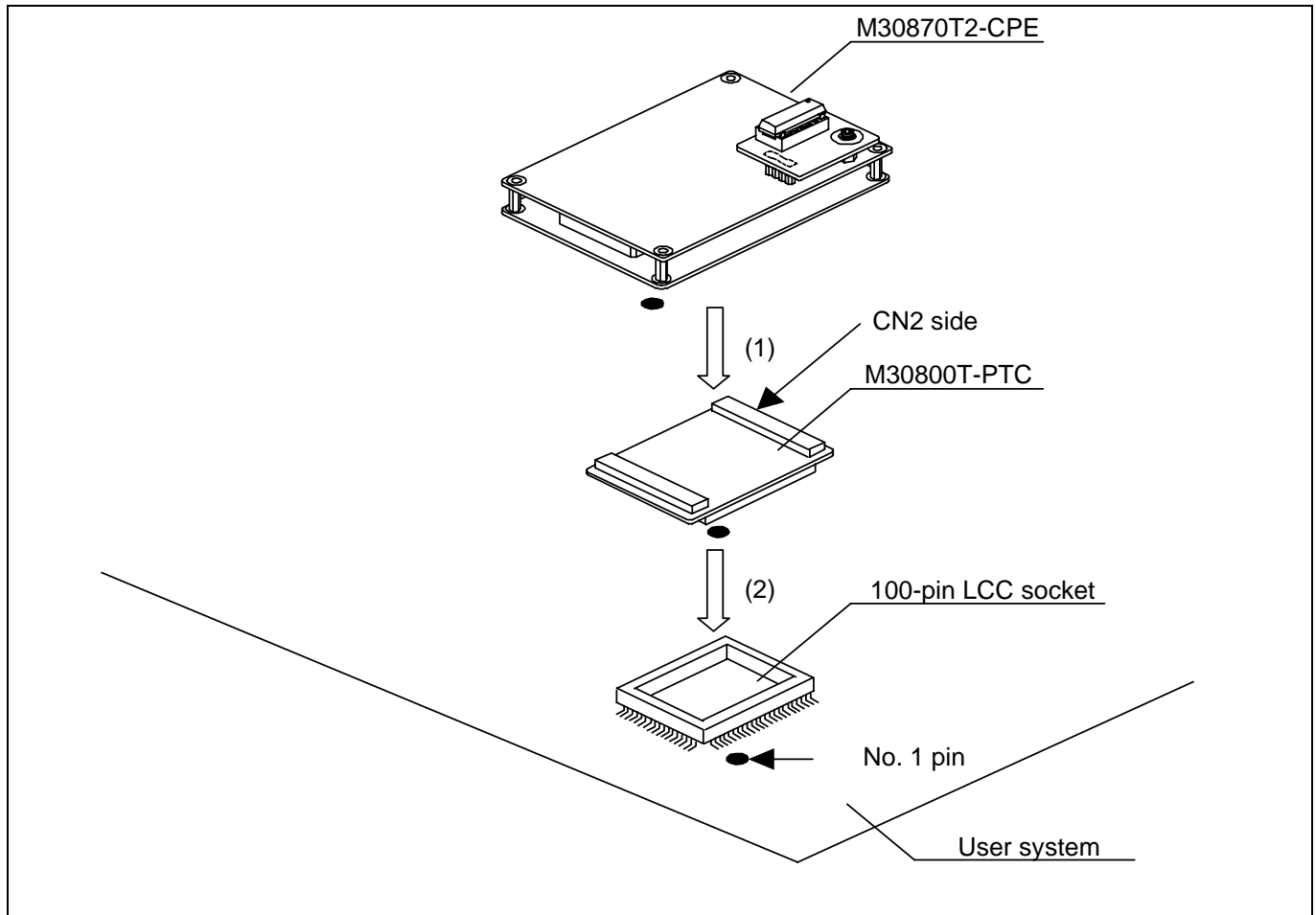


Figure 2.12 Connecting to a 100-pin LCC socket

⚠ CAUTION

Notes on Connecting the User System:



- Take care not to attach a converter board in a wrong direction. It may cause a fatal damage to the emulator and user system.
- The connectors of the M30870T2-CPE and M30800T-PTC are guaranteed for only 50 insertion/removal iterations.
- For purchasing the IC61-1004-051 or for technical information, contact Yamaichi Electronics Co., Ltd.

2.8.2 Connecting to a 100-pin 0.65-mm-pitch Foot Pattern (Part 1)

Figure 2.13 shows how to connect the compact emulator to a 100-pin 0.65-mm-pitch foot pattern on the user system with the M3T-DUMMY100S (not included), and here following is its procedure.

For details on the M3T-100LCC-DMS and M3T-DUMMY100S, refer to each user's manual.

- (1) Mount the M3T-DUMMY100S to the user system.
- (2) Attach the M3T-100LCC-DMS to the M3T-DUMMY100S.
- (3) Attach the M30800T-PTC to the M30870T2-CPE.
- (4) Attach the M30800T-PTC to the M3T-100LCC-DMS.

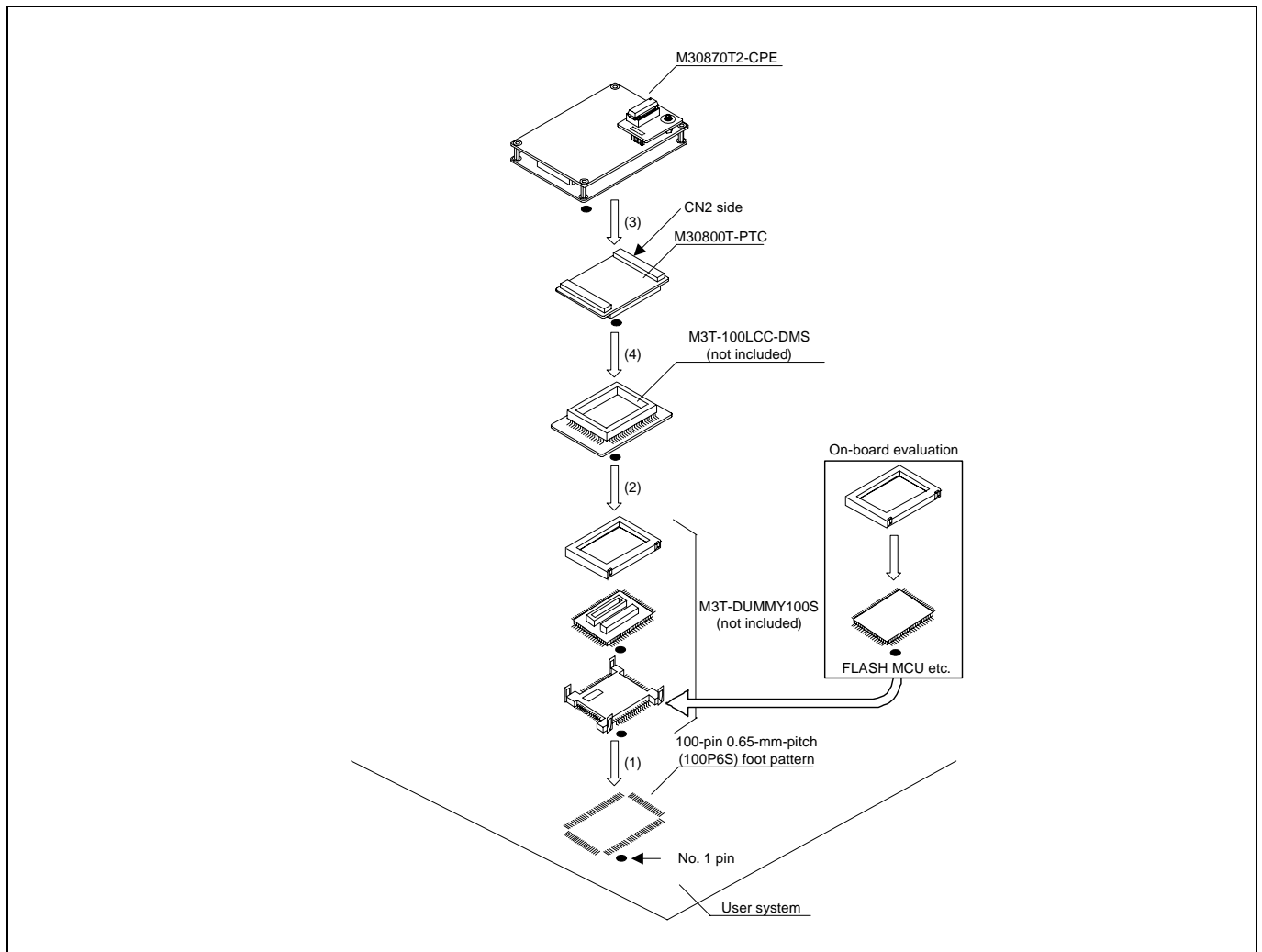


Figure 2.13 Connecting to a 100-pin 0.65-mm-pitch foot pattern (part 1)

⚠ CAUTION

Notes on Connecting the User System:



- Take care not to attach a converter board in a wrong direction. It may cause a fatal damage to the emulator and user system.
- The small connectors of the M3T-100LCC-DMS and the M3T-DUMMY100S are guaranteed for only 20 insertion/removal iterations.
- The small connectors of the M30870T2-CPE and M30800T-PTC are guaranteed for only 50 insertion/removal iterations.

2.8.3 Connecting to a 100-pin 0.65-mm-pitch Foot Pattern (Part 2)

Figure 2.14 shows how to connect the compact emulator to a 100-pin 0.65-mm-pitch foot pattern on the user system with the M3T-DIRECT100S (not included), and here following is its procedure. For details on the M3T-100LCC-DMS and M3T-DIRECT100S, refer to each user's manual.

- (1) Attach the M30800T-PTC to the user system.
- (2) Attach the M3T-DIRECT100S to the M30800T-PTC.
- (3) Attach the M30800T-PTC to the M30870T2-CPE.
- (4) Attach the M3T-100LCC-DMS to the M30800T-PTC.

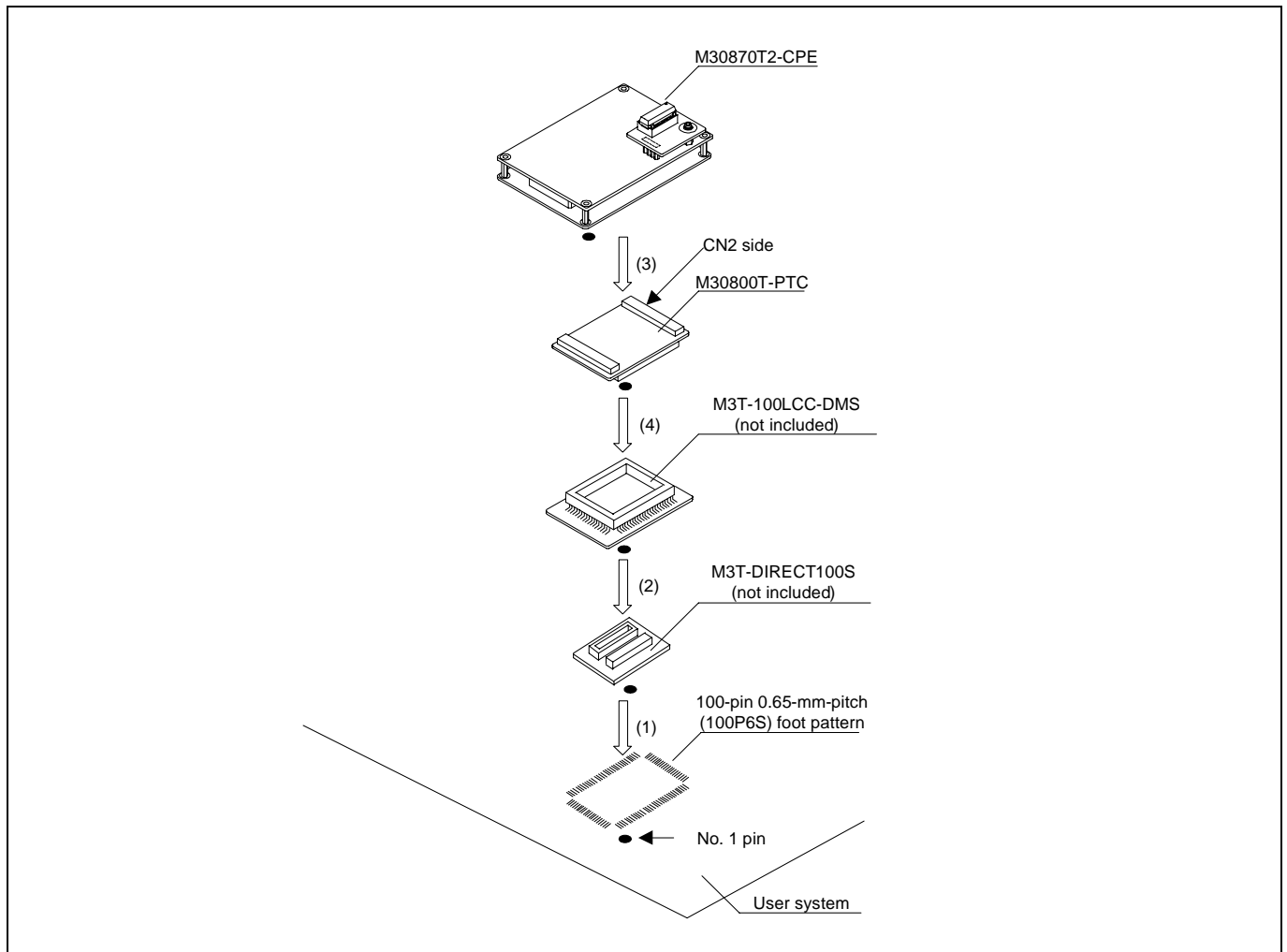


Figure 2.14 Connecting to a 100-pin 0.5-mm-pitch foot pattern (part 2)

⚠ CAUTION

Notes on Connecting the User System:



- Take care not to attach a converter board in a wrong direction. It may cause a fatal damage to the emulator and user system.
- The small connectors of the M3T-100LCC-DMS and M3T-DIRECT100S are guaranteed for only 20 insertion/removal iterations.
- The small connectors of the M30870T2-CPE and M30800T-PTC are guaranteed for only 50 insertion/removal iterations.

2.8.4 Connecting to a 100-pin 0.65-mm-pitch Foot Pattern (Part 3)

Figure 2.15 shows how to connect the compact emulator to a 100-pin 0.65-mm-pitch foot pattern on the user system with the M3T-FLX-100NRB (not included), and here following is its procedure. For details on the M3T-100LCC-DMS and M3T-FLX-100NRB, refer to each user's manual.

- (1) Attach the M3T-FLX-100NRB to the user system.
- (2) Attach the M3T-100LCC-DMS to the M3T-FLX-100NRB.
- (3) Attach the M30800T-PTC to the M30870T2-CPE.
- (4) Attach the M30800T-PTC to the M3T-100LCC-DMS.

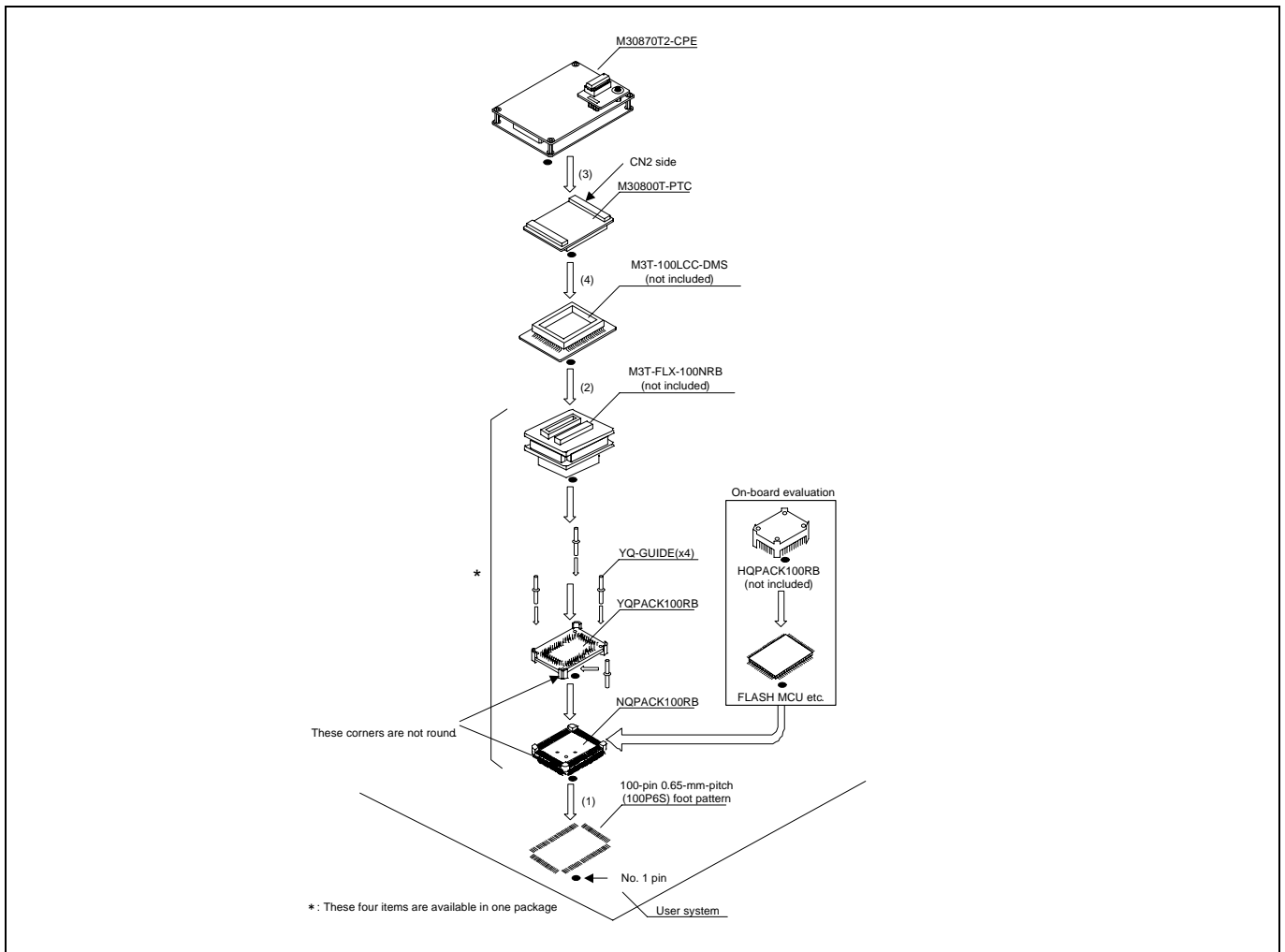


Figure 2.15 Connecting to an 100-pin 0.65-mm-pitch foot pattern (part 3)

⚠ **CAUTION**

Notes on Connecting the User System:

- Take care not to attach a converter board in a wrong direction. It may cause a fatal damage to the emulator and user system.
- The small connectors of the M3T-100LCC-DMS and M3T-FLX-100NRB are guaranteed for only 20 insertion/removal iterations.
- The small connectors of the M30870T2-CPE and M30800T-PTC are guaranteed for only 50 insertion/removal iterations.

*NQPACK, YQPACK, YQSOCKET, YQ-GUIDE, HQPACK, TQPACK and TQSOCKET are trademarks of Tokyo Eletech Corporation.

2.8.5 Connecting to a 100-pin 0.5-mm-pitch Foot Pattern (Part 1)

Figure 2.16 shows how to connect the compact emulator to a 100-pin 0.5-mm-pitch foot pattern on the user system with the M3T-100LCC-QSD (not included), and here following is its procedure. For details on the M3T-100LCC-QSD, refer to its user's manual.

- (1) Attach the M3T-100LCC-QSD to the user system.
- (2) Attach the M30800T-PTC to the M30870T2-CPE.
- (3) Attach the M30800T-PTC to the M3T-100LCC-QSD.

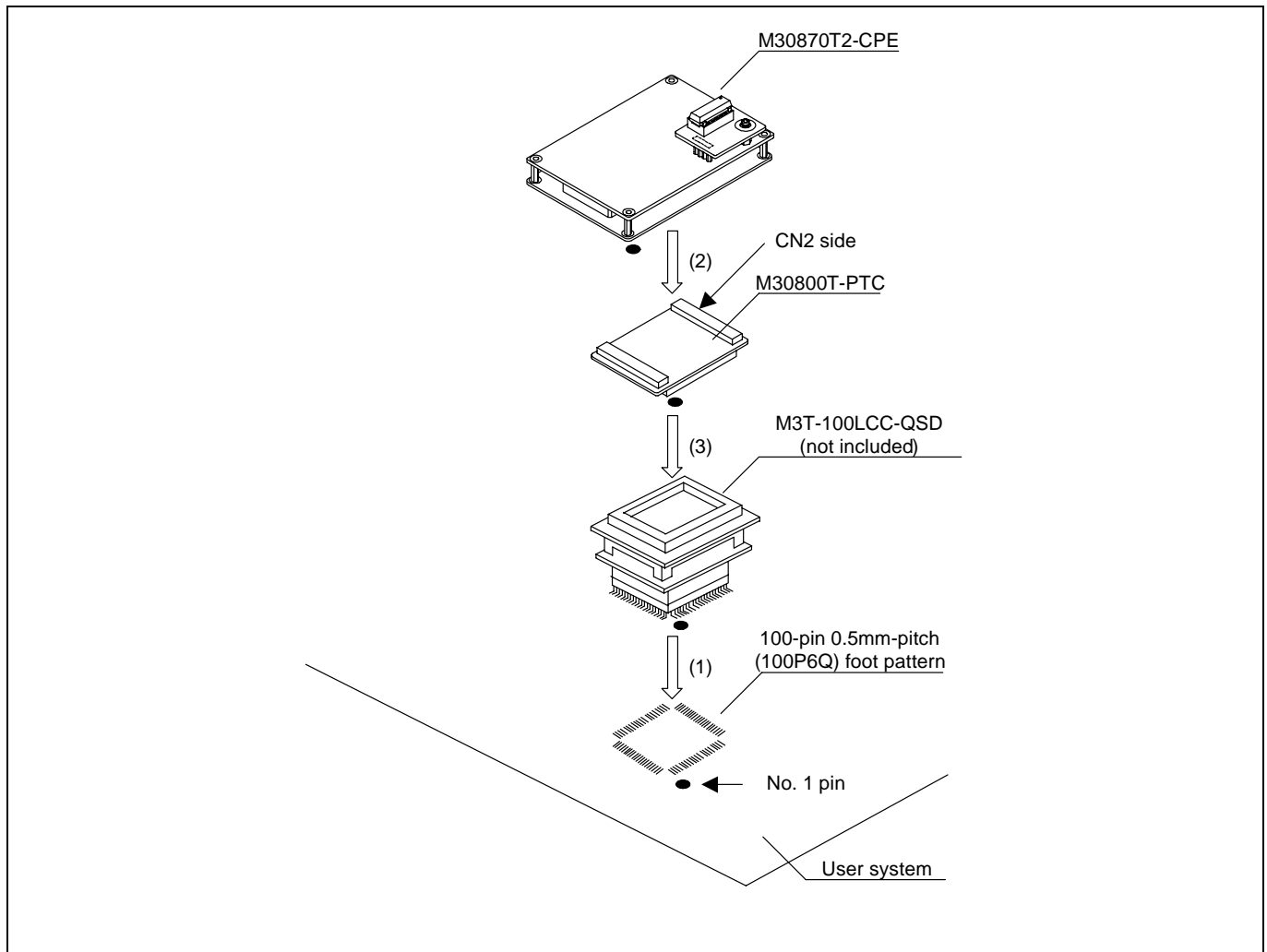


Figure 2.16 Connecting to a 100-pin 0.5-mm-pitch foot pattern (part 1)

⚠ CAUTION

Notes on Connecting the User System:



- Take care not to attach the converter board in a wrong direction. It may cause a fatal damage to the emulator and the user system.
- The small connectors of the M30870T2-CPE and M30800T-PTC are guaranteed for only 50 insertion/removal iterations.

2.8.6 Connecting to a 100-pin 0.5-mm-pitch Foot Pattern (Part 2)

Figure 2.17 shows how to connect the compact emulator to a 100-pin 0.5-mm-pitch foot pattern on the user system with the M3T-FLX-100NSD (not included), and here following is its procedure. For details on the M3T-100LCC-DMS and M3T-FLX-100NSD, refer to each user's manual.

- (1) Attach the M3T-FLX-100NSD to the user system.
- (2) Attach the M3T-100LCC-DMS to the M3T-FLX-100NSD.
- (3) Attach the M30800T-PTC to the M30870T2-CPE.
- (4) Attach the M30800T-PTC to the M3T-100LCC-DMS.

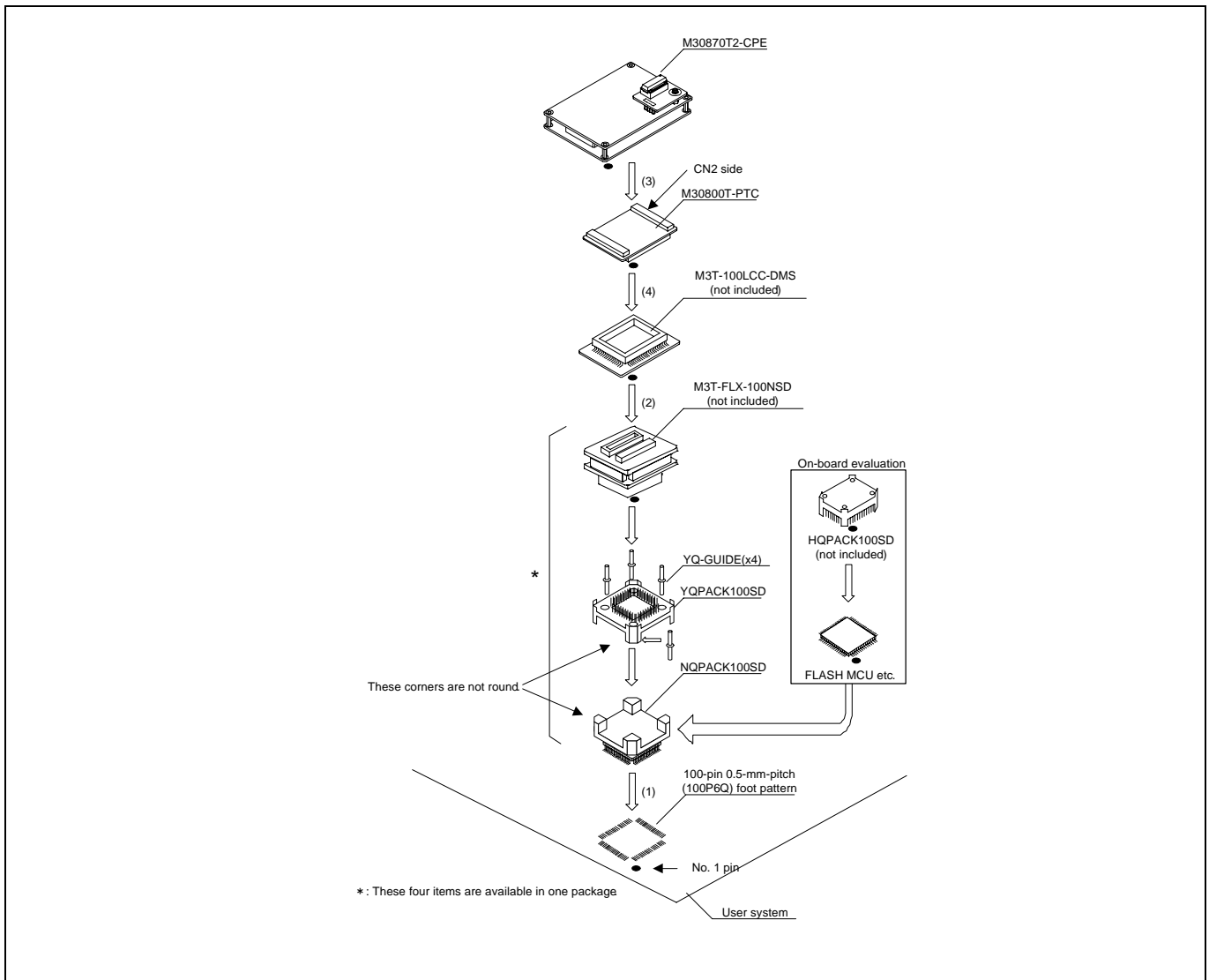


Figure 2.17 Connecting to a 100-pin 0.5-mm-pitch foot pattern (part 2)

CAUTION

Notes on Connecting the User System:



- Take care not to attach the converter board in a wrong direction. It may cause a fatal damage to the emulator and user system.
- The small connectors of the M3T-100LCC-DMS and M3T-FLX-100NSD are guaranteed for only 20 insertion/removal iterations.
- The small connectors of the M30870T2-CPE and M30800T-PTC are guaranteed for only 50 insertion/removal iterations.

2.8.7 Connecting to a 100-pin 0.5-mm-pitch Foot Pattern (Part 3)

Figure 2.18 shows how to connect the compact emulator to a 100-pin 0.5-mm-pitch foot pattern on the user system with the M3T-F160-100NSD (not included), and here following is its procedure. For details on the M3T-F160-100NSD, refer to its user's manual.

- (1) Mount the NQPACK100SD included with the M3T-F160-100NSD to the user system.
- (2) Attach the YQPACK100SD included with the M3T-F160-100NSD to the NQPACK100SD.
- (3) Insert the YQ-GUIDE's included with the YQPACK100SD to the YQPACK100SD.
- (4) Attach the M3T-F160-100NSD to the YQPACK100SD.
- (5) Attach the M30870T2-CPE to the M3T-F160-100NSD.

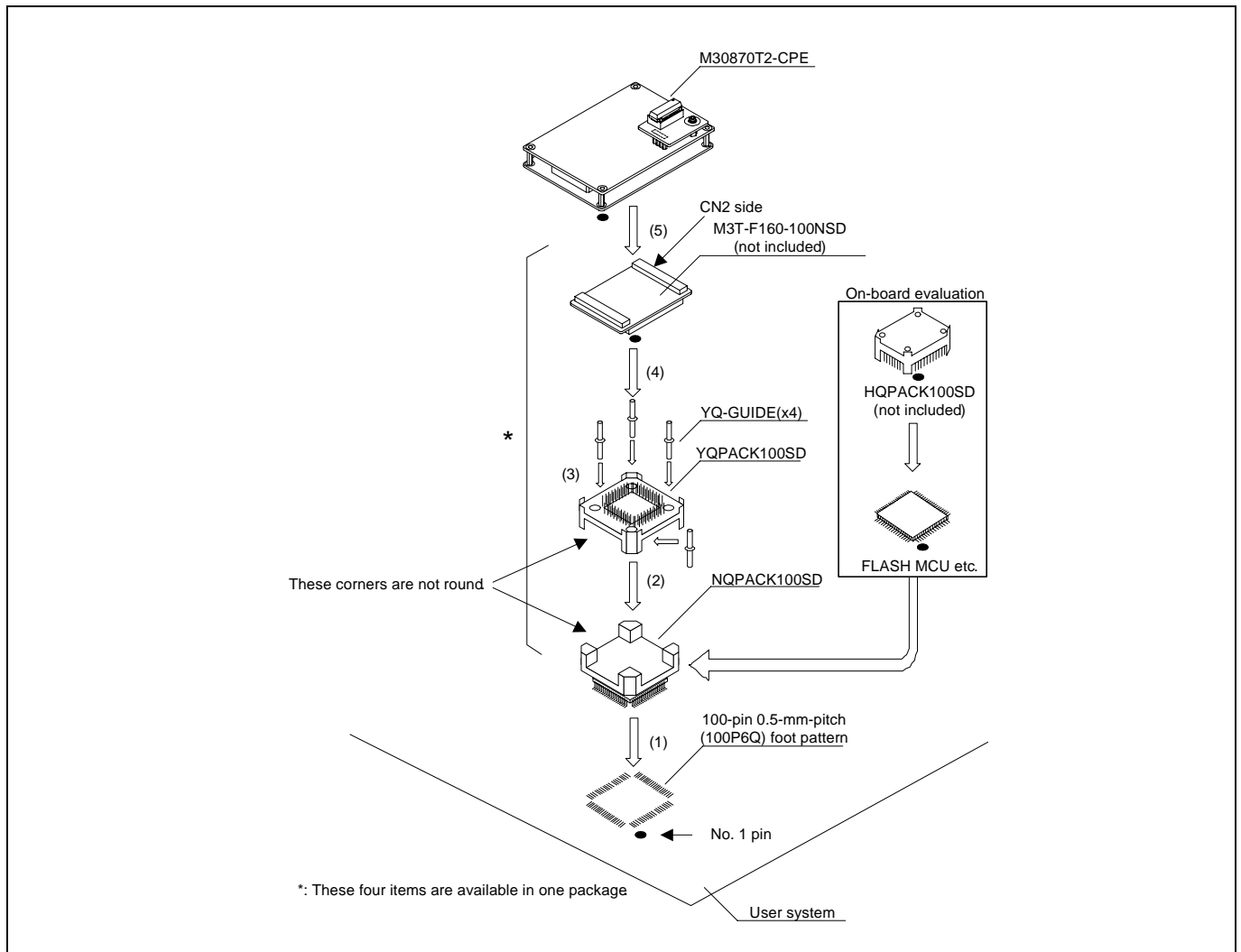


Figure 2.18 Connecting to a 100-pin 0.5-mm-pitch foot pattern (part 3)

⚠ CAUTION

Notes on Connecting the User System:



- Take care not to attach the converter board in a wrong direction. It may cause a fatal damage to the emulator and user system.
- The small connectors of the M30870T2-CPE and M3T-F160-100NSD are guaranteed for only 50 insertion/removal iterations.

2.8.8 Connecting to a 144-pin 0.5-mm-pitch Foot Pattern

Figure 2.19 shows how to connect the compact emulator to a 144-pin 0.5-mm-pitch foot pattern on the user system with the M3T-FLX-144NSD (not included), and here following is its procedure. For details on the M3T-FLX-144NSD, refer to its user's manual.

- (1) Attach the NQPACK144SD included with the M3T-FLX-144NSD to the user system.
- (2) Attach the YQPACK144SD included with the M3T-FLX-144NSD to the NQPACK144SD.
- (3) Insert the YQ-GUIDE's included with the YQPACK144SD to the YQPACK144SD.
- (4) Attach the M3T-FLX-144NSD to the YQPACK144SD.
- (5) Attach the M30870T2-CPE to the M3T-FLX-144NSD.

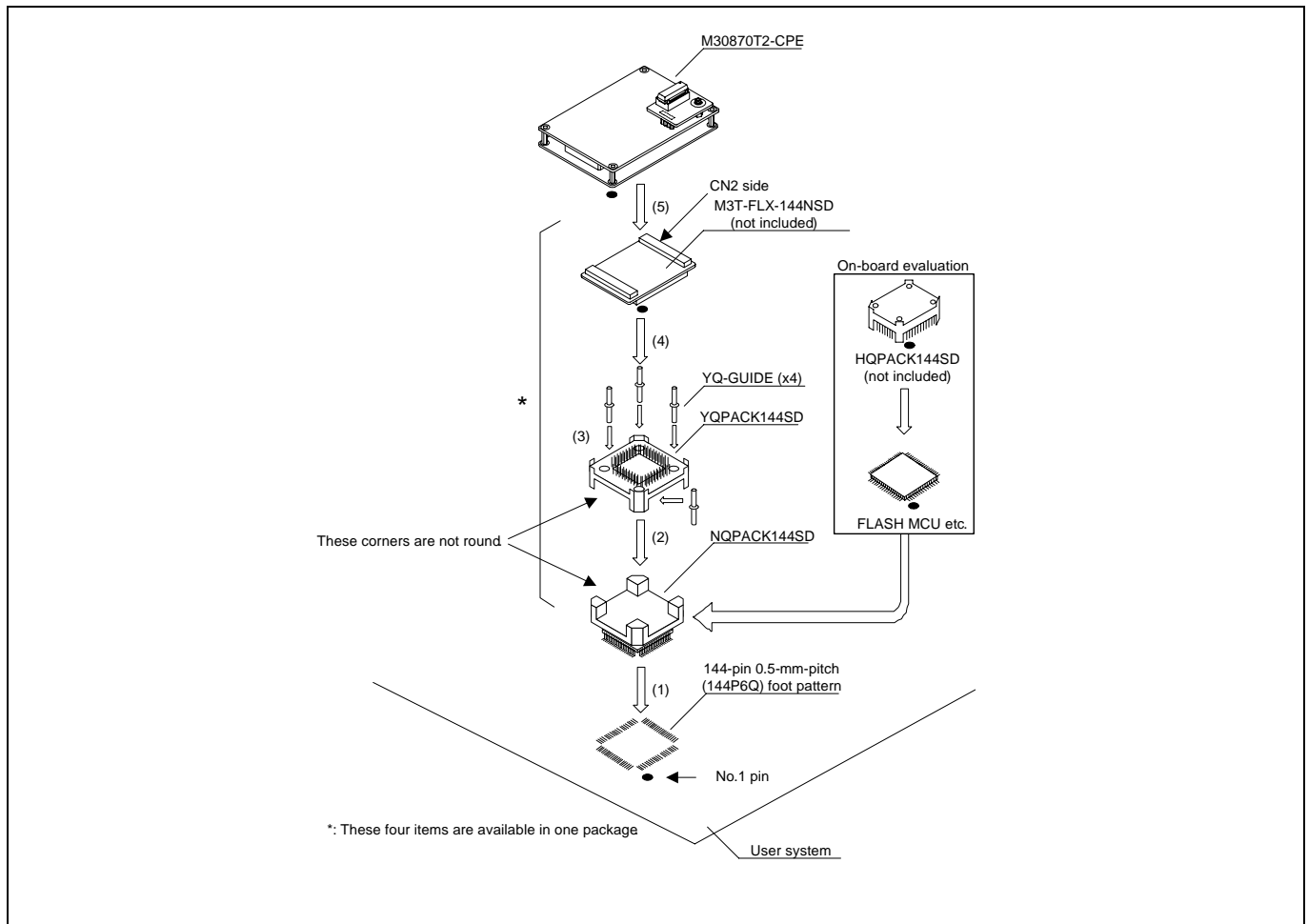


Figure 2.19 Connecting to a 144-pin 0.5-mm-pitch foot pattern

CAUTION

Notes on Connecting the User System:



- Take care not to attach the converter board in a wrong direction. It may cause a fatal damage to the emulator and user system.
- The small connectors of the M30870T2-CPE and M3T-FLX-144NSD are guaranteed for only 50 insertion/removal iterations.

2.9 Changing Settings

2.9.1 Setting Switches of Emulator

Set the switches of the emulator according to the condition. Figures 2.20 and 2.21 show the positions of the switches of the M30870T2-CPE with the M30870T-EPBM REV.B and M30870T-EPBM REV.C, respectively.

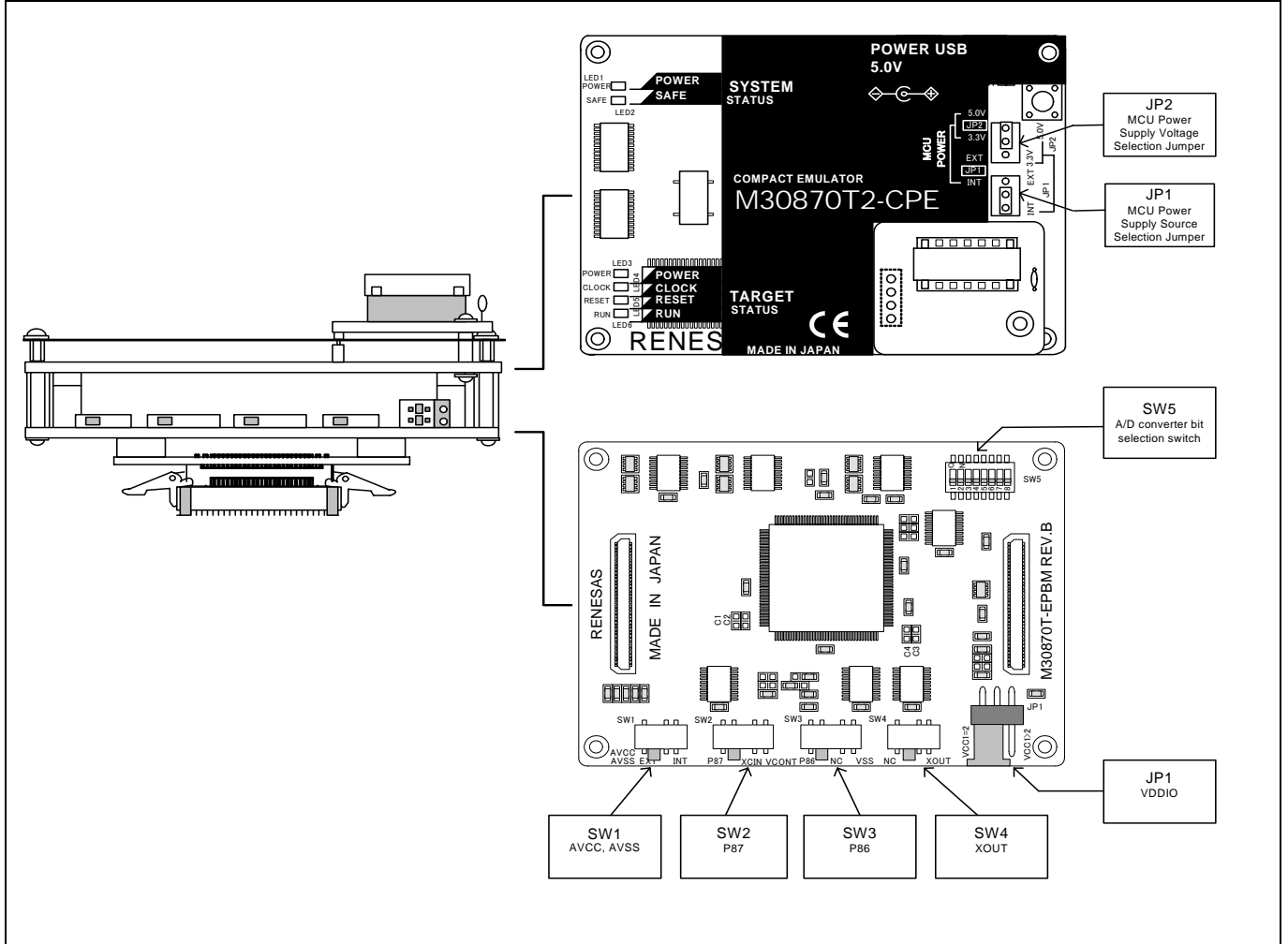


Figure 2.20 Positions of the switches (with M30870T-EPBM REV.B)

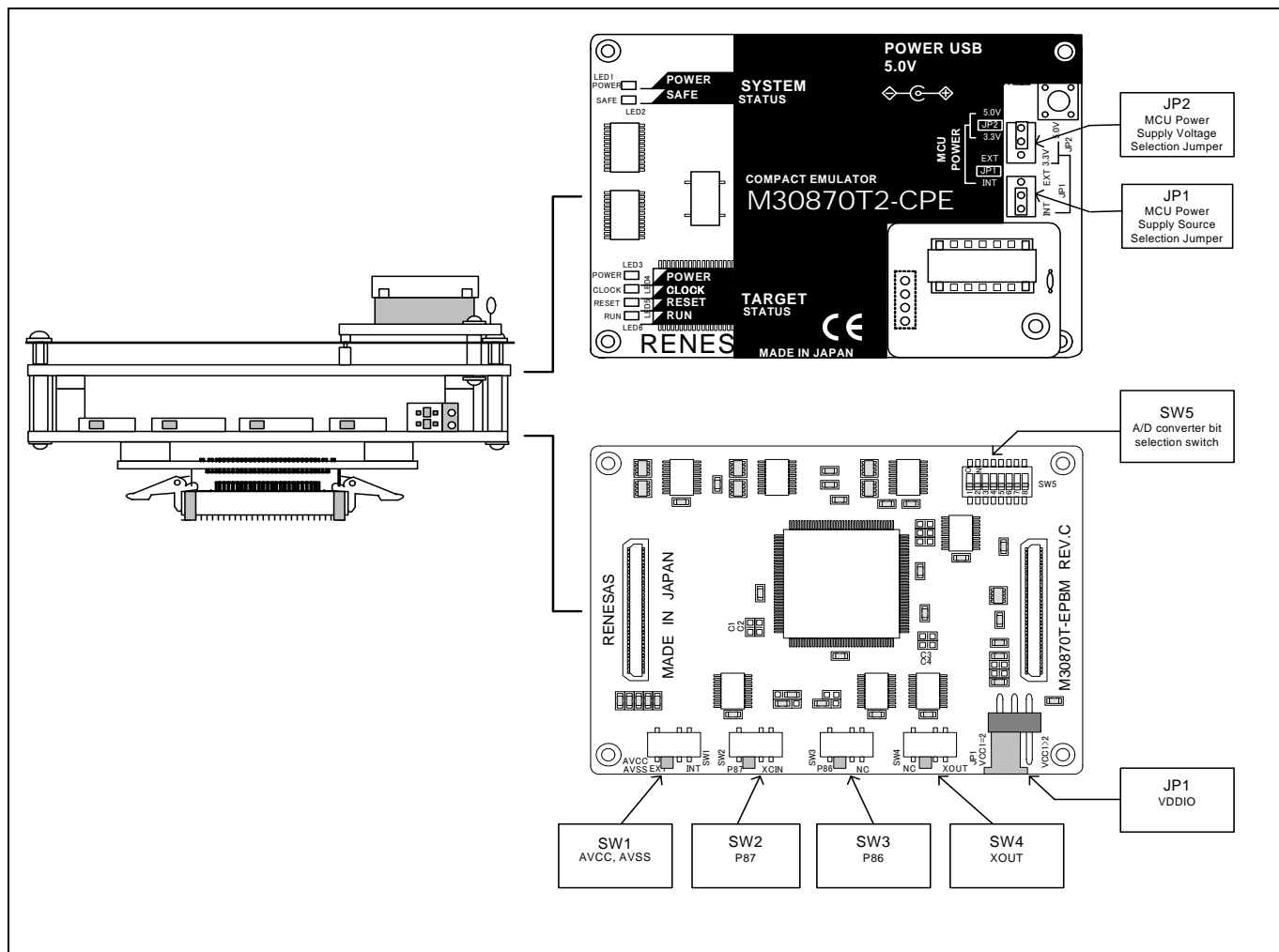


Figure 2.21 Positions of the switches (with M30870T-EPBM REV.C)

(1) MCU Power Supply Source Selection Jumper/MCU Power Supply Voltage Selection Jumper

These are the jumper switches to select power supply to the MCU and its power voltage. As shown in Table 2.5 below, set the switch according to the connection to the user system.

Table 2.5 Setting jumper switches

Connection to the user system	MCU power supply source selection jumper (JP1)	MCU power supply voltage selection jumper (JP2)	Description
Not connected	INT	3.3 V	Supplied from the emulator. The MCU operating voltage is 3.3 V.
		5.0 V	Supplied from the emulator. The MCU operating voltage is 5.0 V.
Connected	EXT	Invalid	Supplied from the user system. This emulator consumes max. 500 mA of electrical current from the user system.

 **CAUTION**

Note on Setting Jumper Switches:

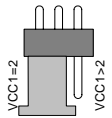
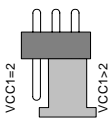
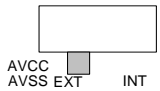

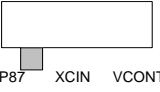
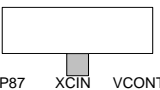
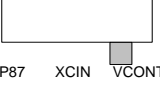

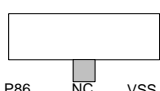

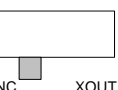
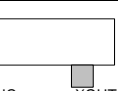


- Always shut OFF the emulator before changing the setting of the jumper switches, and connecting the cable. Otherwise the internal circuit may cause a break.
- When the MCU power supply source selection jumper is set to INT and the MCU power supply voltage selection jumper is set to 5.0 V, the JP1 of the M30870T-EPBM can only be set as VCC1 = VCC2.

(2) Setting JP1, SW1 to SW4 on the M30870T-EPBM

Table 2.6 shows the settings of JP1, SW1 to SW4 on the M30870T-EPBM REV.B, and Table 2.7 shows the settings of JP1, SW1 to SW4 on the M30870T-EPBM REV.C.

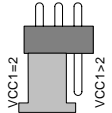
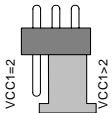

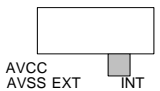
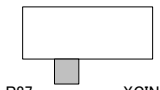
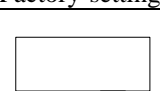
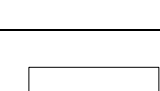
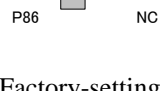
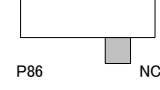
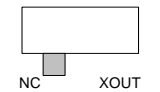
Table 2.6 Switch settings of the M30870T-EPBM REV.B (JP1, SW1 to SW4)

Switch	Switch name	Setting	Description
JP1*	VDDIO	 (Factory-setting)	$3.0\text{ V} \leq \text{VCC1} = \text{VCC2} \leq 5.5\text{ V}$
		 (Factory-setting)	$4.8\text{ V} \leq \text{VCC1} \leq 5.2\text{ V}$ and $3.0\text{ V} \leq \text{VCC2} < \text{VCC1}$
SW1	AVCC AVSS	 (Factory-setting)	Connects pins AVCC and AVSS of the MCU to the user system.
		 (Factory-setting)	Connects pin AVCC of the MCU to the internal power supply of the emulator, and connects pin AVSS to the GND in the emulator.
SW2	P87	 (Factory-setting)	Connects pin P87 of the MCU to the user system.
		 (Factory-setting)	Connects pin P87 of the MCU to the sub-clock oscillator circuit (32.768 kHz).
		 (Factory-setting)	Do not set to VCONT. Pin P87 is disconnected.
SW3	P86	 (Factory-setting)	Connects pin P86 of the MCU to the user system.
		 (Factory-setting)	Does not connect pin P86 of the MCU.
		 (Factory-setting)	Do not set to VSS. Connects pin P86 to the VSS in the emulator.
SW4	XOUT	 (Factory-setting)	Does not connect pin XOUT of the MCU.
		 (Factory-setting)	Connects pin XOUT of the MCU to the user system.

* This JP1 is not the MCU Power Supply Source Selection Jumper (JP1) on the upper side of the emulator.

Be careful about the direction when connecting.

Table 2.7 Switch settings of the M30870T-EPBM REV.C (JP1, SW1 to SW4)

Switch	Switch name	Setting	Description
JP1*	VDDIO	 (Factory-setting)	$3.0\text{ V} \leq \text{VCC1} = \text{VCC2} \leq 5.5\text{ V}$
			$4.8\text{ V} \leq \text{VCC1} \leq 5.2\text{ V}$ and $3.0\text{ V} \leq \text{VCC2} < \text{VCC1}$
SW1	AVCC AVSS	 (Factory-setting)	Connects pins AVCC and AVSS of the MCU to the user system.
			Connects pin AVCC of the MCU to the internal power supply of the emulator, and connects pin AVSS to the GND in the emulator.
SW2	P87	 (Factory-setting)	Connects pin P87 of the MCU to the user system.
			Connects pin P87 of the MCU to the sub-clock oscillator circuit (32.768 kHz).
SW3	P86	 (Factory-setting)	Connects pin P86 of the MCU to the user system.
			Does not connect pin P86 of the MCU.
SW4	XOUT	 (Factory-setting)	Does not connect pin XOUT of the MCU.
			Connects pin XOUT of the MCU to the user system.

* This JP1 is not the MCU Power Supply Source Selection Jumper (JP1) on the upper side of the emulator.
Be careful about the direction when connecting.

(3) Setting SW5 on the M30870T-EPBM

Table 2.8 lists the examples of setting the switch SW5. It is necessary to change the setting if using the analog input port selection function of the A/D converter when selecting the MCU file "m30870_ad.mcu" in the Init dialog box of the emulator debugger.

Setting the SW5 enables to set each analog input pin for selecting an analog input port. When selecting AN00 to AN07 or AN20 to AN27 for the analog input port select bits (bit 2 and bit 1 of 0394h), set the pins used for A/D conversion to ON, the pins not used to OFF.

However, when selecting the MCU file "m30870.mcu" in the Init dialog box of the emulator debugger, set the switch SW5 as the factory-settings (all lower side).

Table 2.8 Switch settings of the M30870T-EPBM (SW5)

Analog input port	Setting	Description
When not using the analog input port selection function	<p>AD ON 0 1 2 3 4 5 6 7</p> <p>OFF 0 1 2 3 4 5 6 7</p>	<p>This is the setting when not using the analog input port selection function. When using this product with the conditions below, use this setting.</p> <ul style="list-style-type: none"> - When using the memory expansion mode - When using the multi-port sweep mode - When selecting AN0 to AN7 for analog input port select bits - When selecting AN150 to AN157 for analog input port select bits
When using AN23 to AN27	<p>AD23 to AD27 used: ON</p> <p>AD ON 0 1 2 3 4 5 6 7</p> <p>OFF 0 1 2 3 4 5 6 7</p> <p>AD20 to AD22 unused: OFF</p>	<p>This is a setting when using the analog input port selection function and using AN23 to AN27 for analog input pins. Set the analog input pins to ON. With this setting, set the direction registers of ports P153 to P157 to input. Pins P150 to P152 can be used for I/O port, ISTxD0, ISCLK0 and ISRxD0.</p>
When using AN20 to AN27	<p>AD20 to AD27 used: ON</p> <p>AD ON 0 1 2 3 4 5 6 7</p> <p>OFF 0 1 2 3 4 5 6 7</p>	<p>This is a setting when using the analog input port selection function and using AN20 to AN27 for analog input pins. Set the analog input pins to ON. With this setting, set the direction registers of ports P150 to P157 to input. Pins P150 to P157 cannot be used for I/O port, ISTxD0, ISCLK0 and ISRxD0.</p>
When using AN04 to AN07	<p>AD04 to AD07 used: ON</p> <p>AD ON 0 1 2 3 4 5 6 7</p> <p>OFF 0 1 2 3 4 5 6 7</p> <p>AD00 to AD03 unused: OFF</p>	<p>This is a setting when using the analog input port selection function and using AN04 to AN07 for analog input pins. Set the analog input pins to ON. With this setting, set the direction registers of ports P154 to P157 to input. Pins P150 to P153 can be used for I/O port, ISTxD0, ISCLK0 and ISRxD0.</p>
When using AN03 to AN05 and AN25 to AN27	<p>AD03 to AD05 used: ON AD25 to AD27 used: ON</p> <p>AD ON 0 1 2 3 4 5 6 7</p> <p>OFF 0 1 2 3 4 5 6 7</p> <p>AD00 to AD02 unused: OFF AD20 to AD22 unused: OFF</p>	<p>This is a setting when using the analog input port selection function and using AN03 to AN05 and AN25 to AN27 for analog input pins. Set the analog input pins to ON. With this setting, set the direction registers of ports P153 to P157 to input. Pins P150 to P152 can be used for I/O port, ISTxD0, ISCLK0 and ISRxD0.</p>

IMPORTANT

Notes on Switch JP1:

- If using this product when the voltage of VCC1 is higher than that of VCC2, set the JP1 of the M30870T-EPBM to VCC1>2.
- If using this product when the voltage of VCC1 is higher than that of VCC2, the CPU clock must be 24 MHz or less.

IMPORTANT

Notes on Switch SW5:

When selecting the MCU file "m30870_ad.mcu" in the Init dialog box of the emulator debugger to execute the A/D conversion debug, note the following.

- When using this product in memory expansion mode, be sure to set the all SW5 to ON.
- When setting the register below to use the analog input port selection function, you need to set the direction register of port P15 for a pin that performs A/D conversion to "input".

And you need to set the function selection register of port P15 for a pin that performs A/D conversion to "I/O port".

A/D0 control register 2 (address 394h)

b2, b1

1, 0 : AN00 to AN07

1, 1 : AN20 to AN27

Also, when the P0 group and P2 group are selected for A/D input, port P15 cannot be used as an I/O port. When setting the register above, port P15 cannot be used as an I/O port even if A/D conversion is halting.

- When using the A/D converter in multi-port sweep mode, be sure to set the all SW5 to ON. When setting the register below to use multi-port sweep mode, you need to set the direction register of port P15 for a pin that performs A/D conversion to "input".

And you need to set the function selection register of port P15 for a pin that performs A/D conversion to "I/O port".

A/D0 control register 4 (address 392h)

b3, b2

1, 0 : AN0 to AN7, AN00 to AN07

1, 1 : AN0 to AN7, AN20 to AN27

Also, when the P0 group and P2 group are used for multi-port sweep mode, port P15 cannot be used as an I/O port. When setting the register above, port P15 cannot be used as an I/O port even if A/D conversion is halting.

Because a converter board and other devices are used between the evaluation MCU and the user system, the A/D converter operates differently from an actual MCU. Make the final evaluation of the A/D converter using an actual MCU.

2.9.2 Selecting Clock Supply

You can choose a clock supplied to the evaluation MCU by the Emulator tab in the Init dialog box of the emulator debugger. Table 2.9 shows the clocks and their initial settings.

Table 2.9 Clock supply to the MCU

Clock	Emulator debugger display	Description	Initial setting
Main (X_{IN} - X_{OUT})	Internal	Internal oscillator circuit board (OSC-3 or OSC-2)	Yes
	External	Oscillator circuit on the user system	-
Sub (X_{CIN} - X_{COUT})	Internal	Internal oscillator circuit (32.768 kHz)	-
	External	Oscillator circuit on the user system	Yes

(1) Using an Internal Oscillator Circuit Board

1. Kinds of Oscillator Boards

The M30870T2-CPE comes with an oscillator circuit board OSC-3 (32 MHz). And an oscillator circuit bare board OSC-2 is included with this product. If you use an internal oscillator circuit board of the emulator as a main clock, choose "Internal" in the emulator debugger after replacing oscillator circuit boards to change a clock supplied to an MCU.

2. Replacing Oscillator Circuit Boards

Figure 2.22 shows how to replace the oscillator circuit boards.

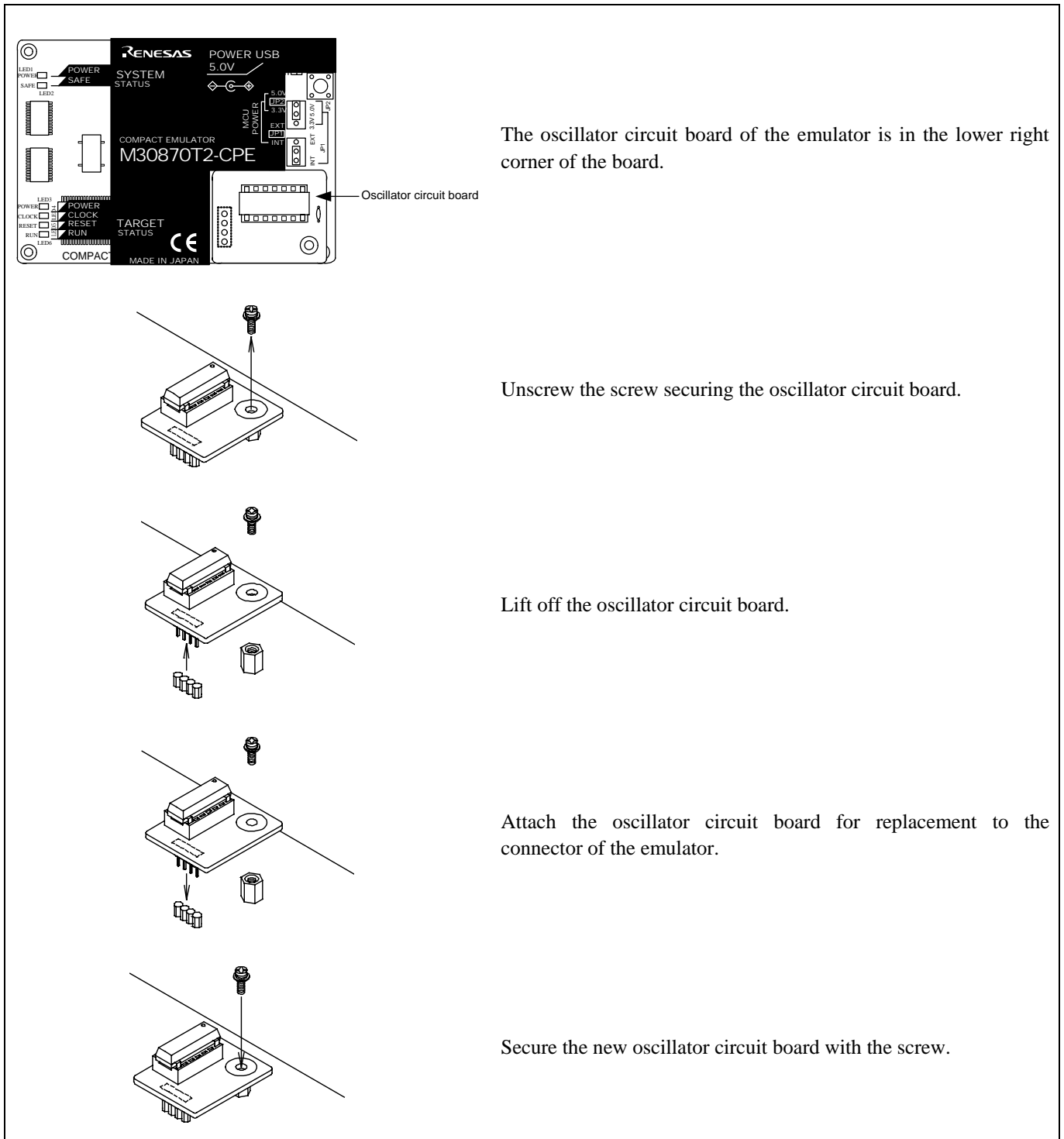


Figure 2.22 Replacing oscillator circuit boards

CAUTION

Note on Replacing the Oscillator Circuit Board:



- When removing the upper cover or replacing the oscillator circuit boards, be sure to shut OFF the power supply. Otherwise the internal circuit may cause a break.

3. Using the Internal Oscillator Circuit Bare Board

To use this product at a frequency you like, build a desired oscillator circuit on the included OSC-2 oscillator circuit bare board. Figure 2.23 shows an external view of the OSC-2 oscillator circuit bare board and the connector pin locations. Figure 2.24 shows the circuitry of the oscillator circuit bare board OSC-2. Use the number of oscillator circuits recommended by the oscillator manufacturer.

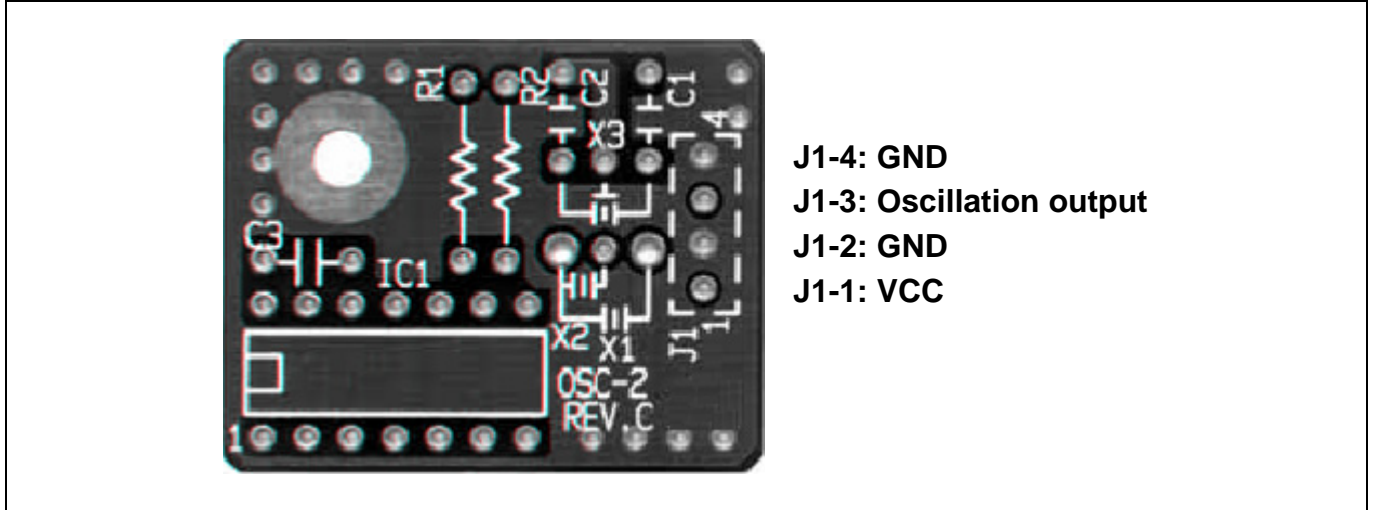


Figure 2.23 External view of the oscillator circuit board OSC-2 and its connector pin locations

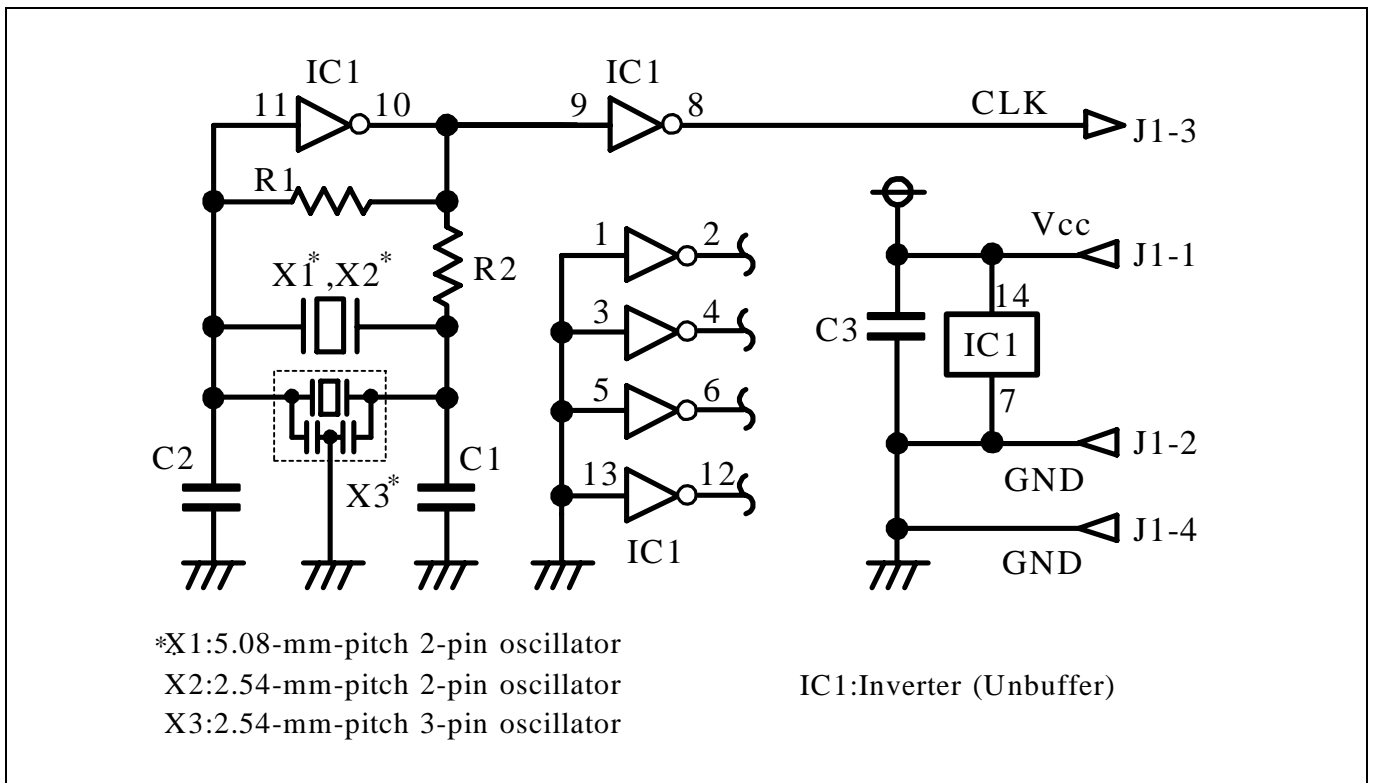


Figure 2.24 Circuits of the oscillator circuit bare board OSC-2

(2) Using an Oscillator Circuit on the User System

To operate this product with an external clock, construct an oscillator circuit as shown in Figure 2.25 in the user system and input the oscillator output at 50% duty (within the operating range of the evaluation MCU) into pin X_{IN} . And pin X_{OUT} should be open. Choose "External" in the emulator debugger to use this clock.

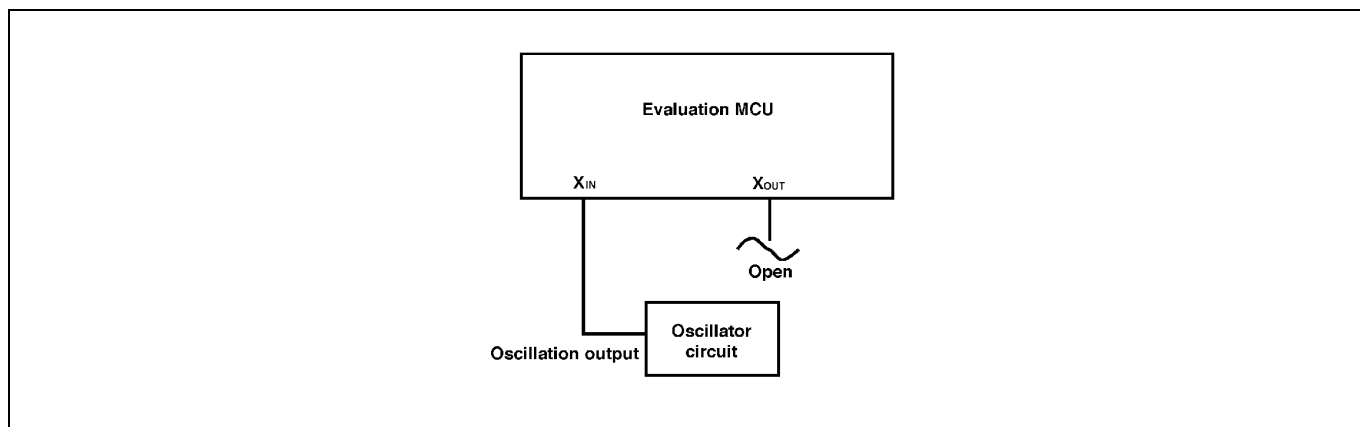


Figure 2.25 External oscillator circuit

Make note that in the oscillator circuit shown in Figure 2.26 where a resonator is connected between pins X_{IN} and X_{OUT} , oscillation does not occur because a converter board and other devices are used between the evaluation MCU and the user system. It is same for sub-clock oscillator circuits (X_{CIN} and X_{COUT}).

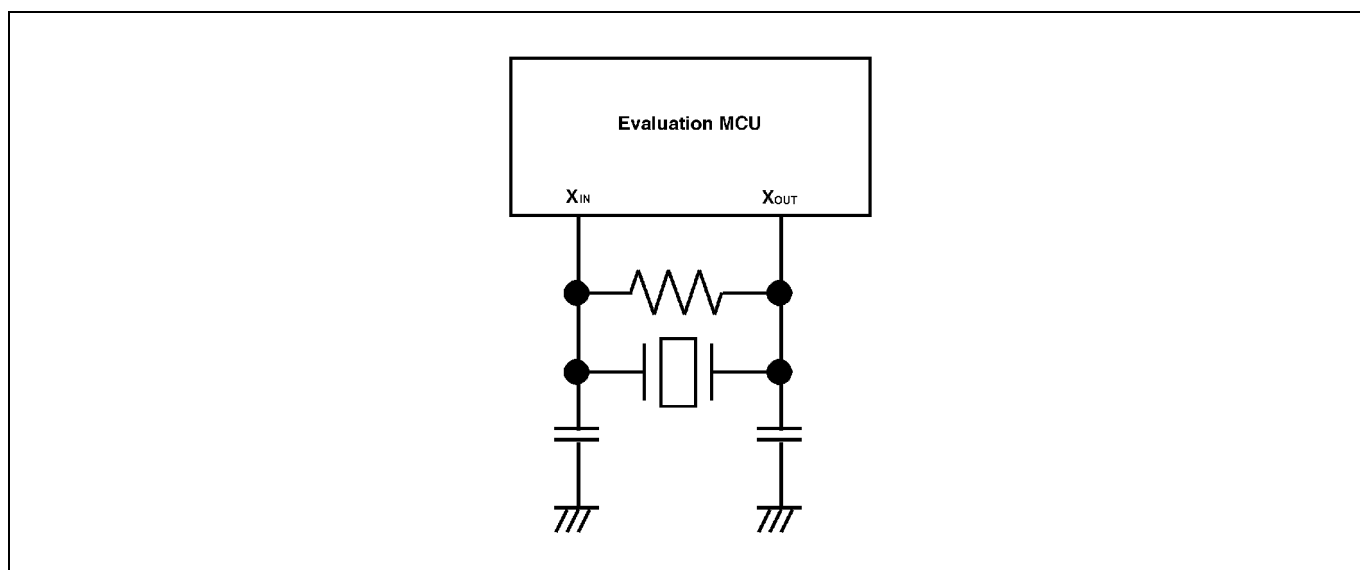


Figure 2.26 Circuit in which oscillation does not occur

2.9.3 A/D Conversion Bypass Capacitors

There is a foot pattern on the M30870T-EPBM board for mounting bypass capacitors for an A/D conversion circuit near the MCU. Mount suitable bypass capacitors as occasion demands. Figure 2.27 shows the mounting location of the A/D conversion bypass capacitors on the M30870T-EPBM REV.B and structure of this product, and Figure 2.28 shows the mounting location of the A/D conversion bypass capacitors on the M30870T-EPBM REV.C and structure of this product.

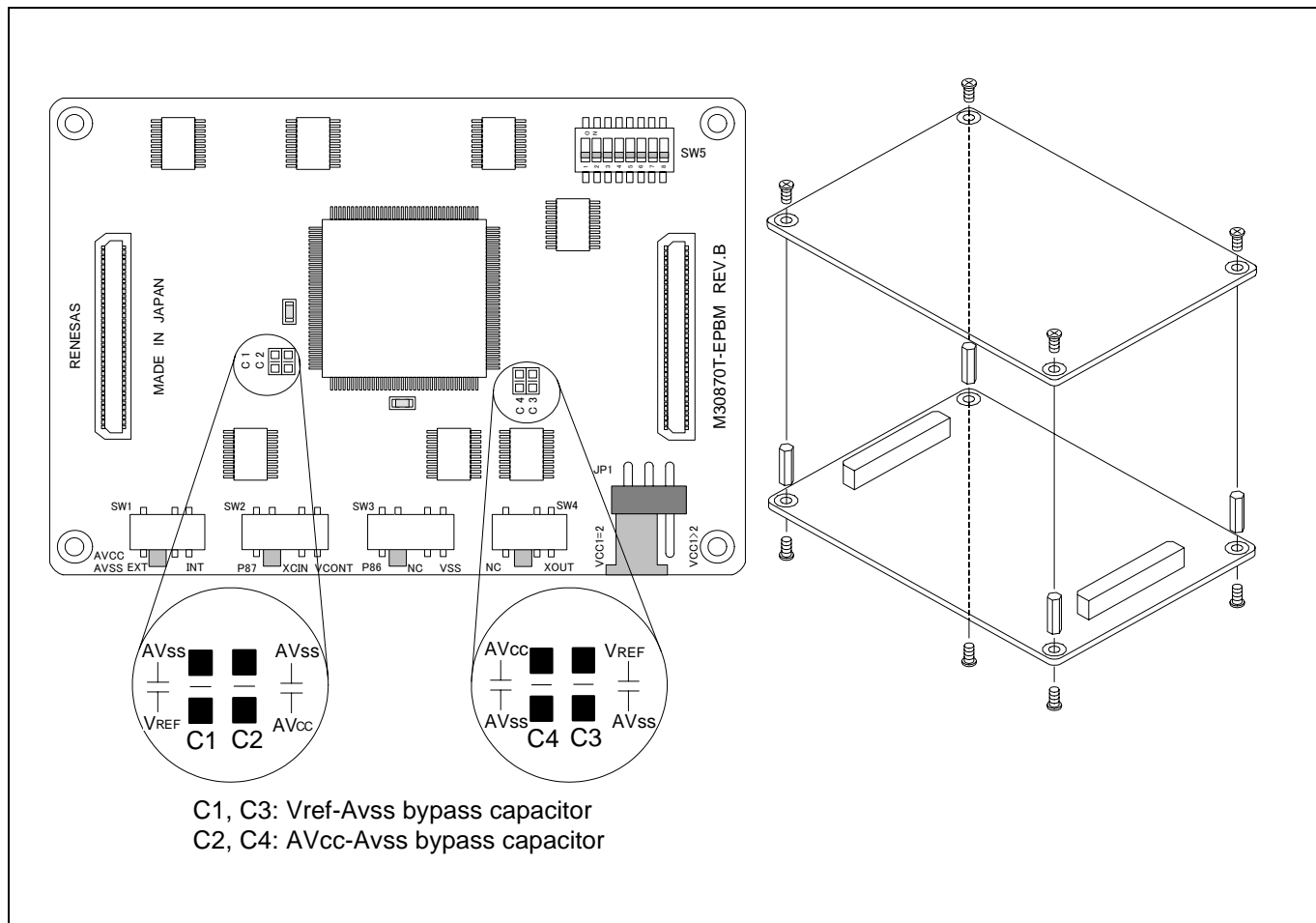


Figure 2.27 Foot pattern for the A/D conversion bypass capacitor on the M30870T-EPBM REV.B

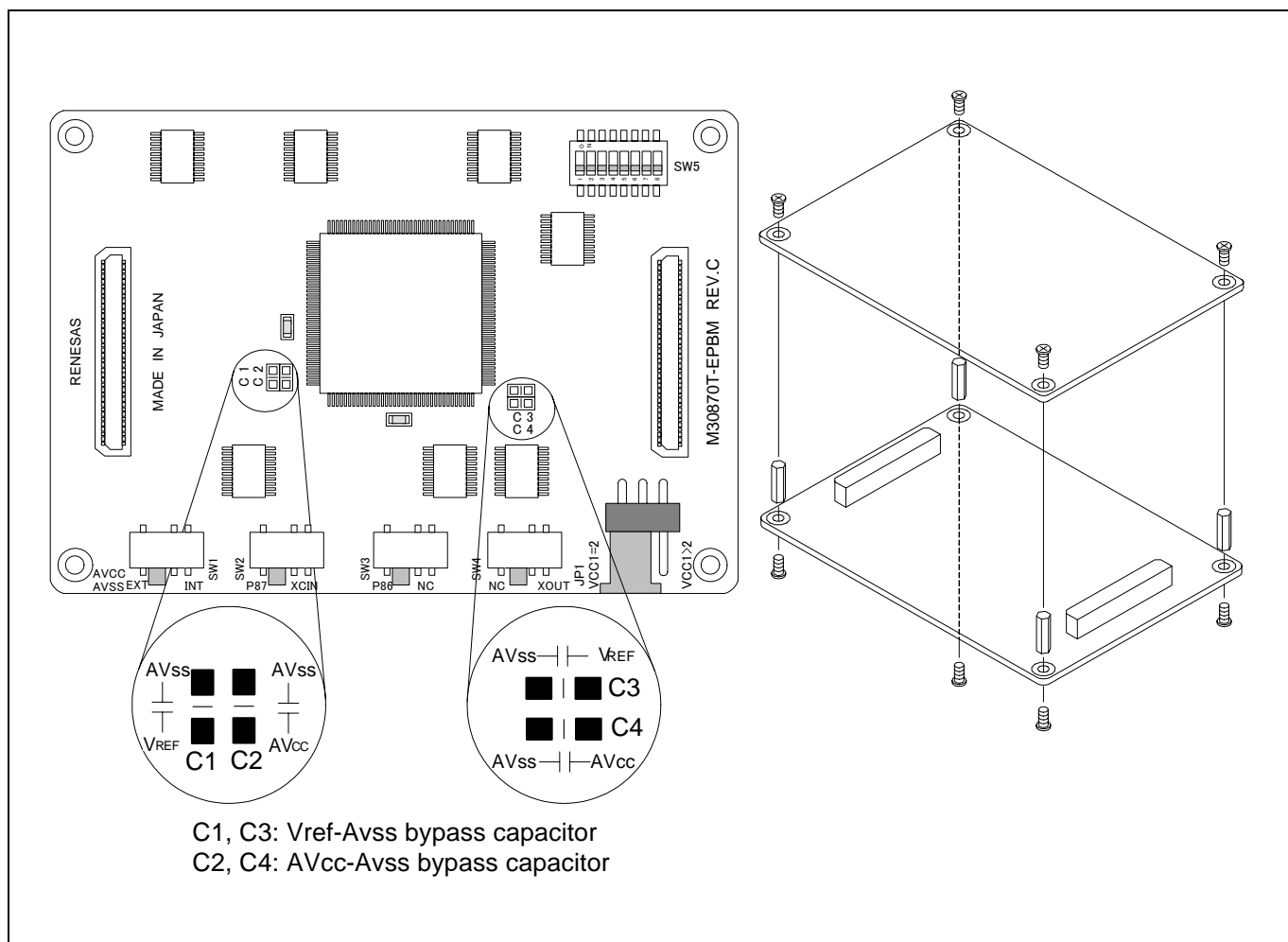


Figure 2.28 Foot pattern for the A/D conversion bypass capacitor on the M30870T-EPBM REV.C

IMPORTANT

Note on the A/D Converter Function:

- Because a converter board and other devices are used between the evaluation MCU and the user system, the A/D converter operates differently from that of an actual MCU. Make the final evaluation of the A/D converter with an actual MCU.

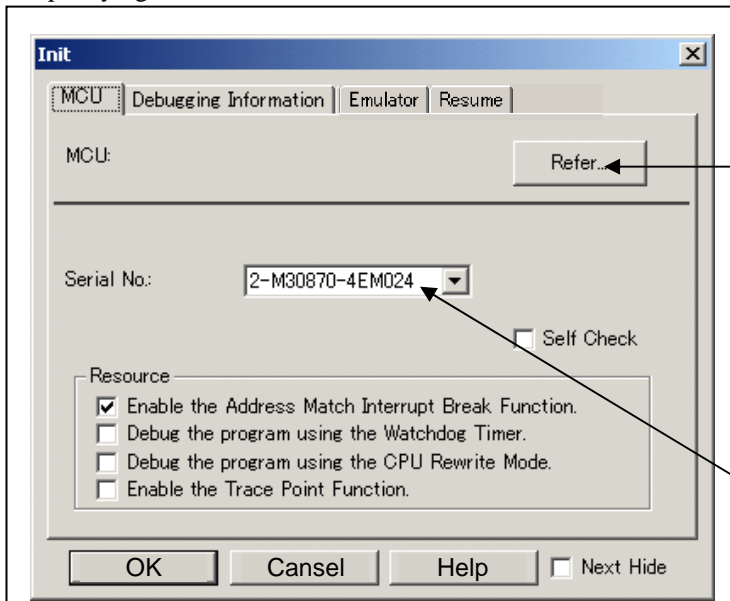
3. Usage (Emulator Debugger)

This chapter describes how to start up the emulator debugger and how to use the major windows.

3.1 Starting Up the Emulator Debugger (Init Dialog Box)

(1) MCU tab

1. Specifying the MCU file

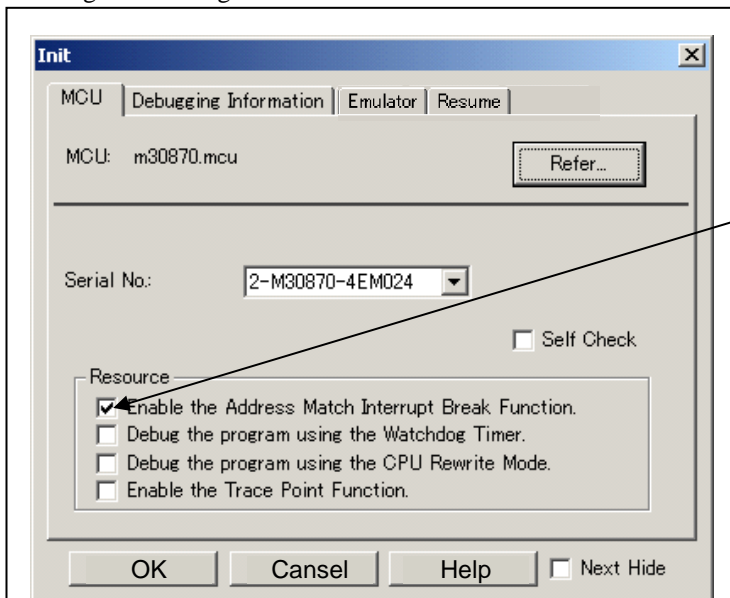


Specifying the MCU file
 Click the "Refer..." button.
 A file selection dialog box will be displayed, so select the desired MCU file.

- The MCU file contains the information specific to the target MCU.
- The MCU file you have selected is displayed in the MCU section of the MCU tab.

Serial No.
 Shows the currently connected emulators in list form. Select the serial No. of the emulator you want to be connected.

2. Using or not using the address match break function

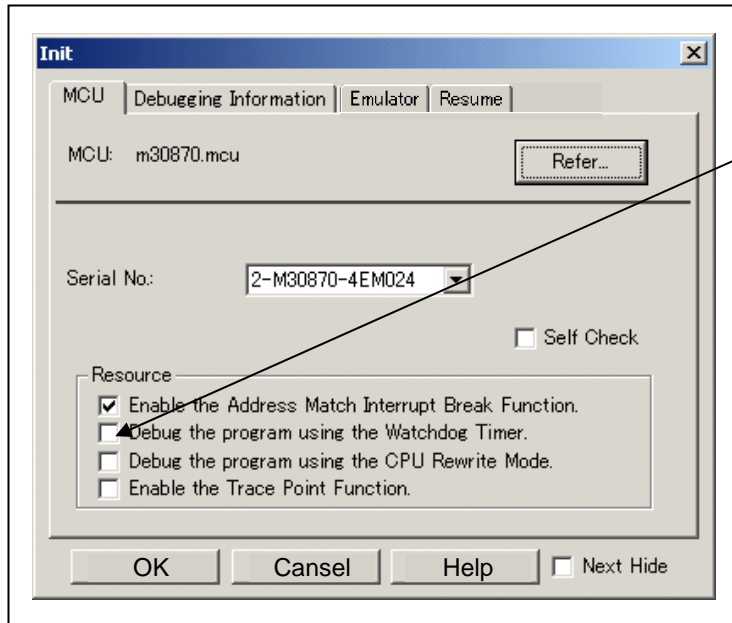


Using or not using the address match break function
 Specify whether or not to use the address match break function.

- To use the address match break function (default), select the check box (marked by a check mark when selected). In this case, the address match interrupt is used by the emulator, and cannot be used in the user program.
- When not using the address match break function, deselect the check box (check mark cleared). In this case, the address match interrupt can be used in the user program.

This option can be selected or deselected only when you are starting up the emulator debugger.

3. Using or not using the watchdog function

**Using or not using the watchdog function**

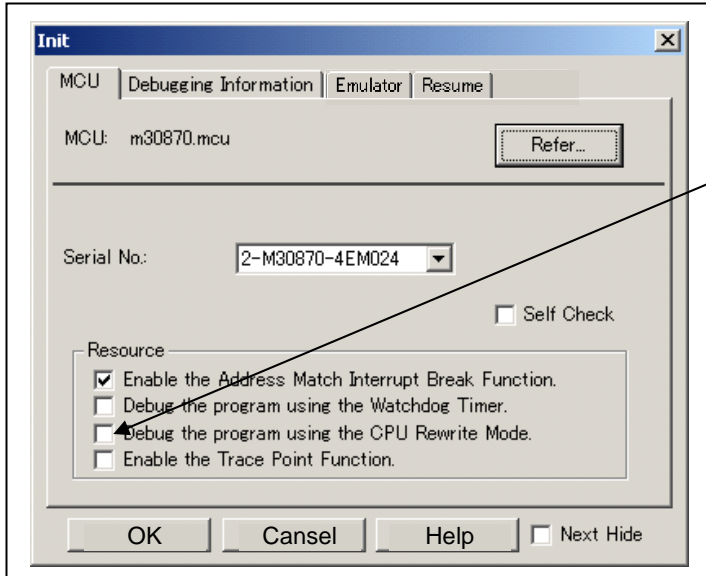
Specify whether or not to debug the program which uses the watchdog function. When debugging the user system which uses the watchdog function, select the check box

IMPORTANT

Notes on selection of whether or not to use the watchdog timer:

- If the check box “Debug the program using the Watchdog Timer” is selected, while the user program remains idle the emulator is performing refresh processing (by writing to the watchdog timer start register) within the emulator control program.
Therefore, the watchdog timer starts after the user program has stopped.
- To use the watchdog timer to debug the user program, select this check box. If this check box is unselected, the emulator may run out of control after the user program has stopped.
- To debug a user system that does not use the watchdog timer, do not select this check box. If this check box is selected, the watchdog timer starts after the user program has stopped, so that if the user program is reexecuted, the watchdog timer underflows generating a watchdog timer interrupt or a reset.

4. Using or not using the CPU rewrite mode



Using or not using CPU rewrite mode

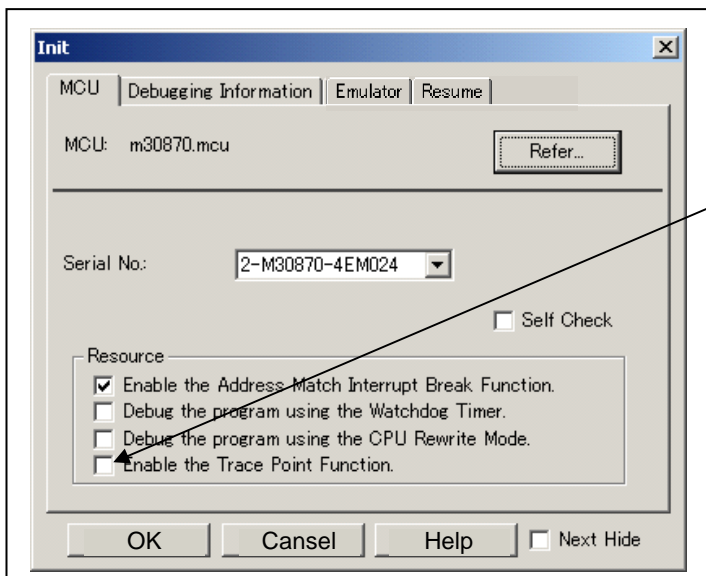
Specify whether or not to debug in CPU rewrite mode. To debug the user system that uses CPU rewrite mode, select the check box. This option can be selected or deselected only when you are starting up the emulator debugger.

[Supplementary explanation]

When debugging in CPU rewrite mode is enabled, the following functions cannot be used:

- Setting the address match breakpoint
- Software breakpoint setting in the internal ROM area
- Execution of COME in the internal ROM area

5. Using or not using the trace point function

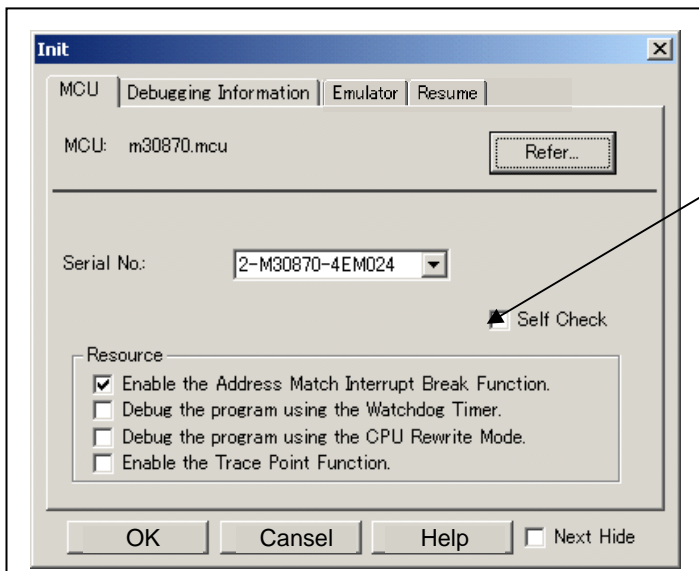


Using or not using the trace point function

The emulator has two-point events, which are shared by the trace function and the hardware break function. Specify whether or not to use the trace point function.

- When not using the trace point function (default), deselect the check box. In this case, the events are used for the hardware break function.
- To use the trace point function, select the check box. In this case, the events are used for the trace point function. The hardware break function is disabled.

6. Executing the self-check



Executing the self-check

Enable this function when you want the emulator to be self-checked at startup. Be sure to select the check box only when you want the emulator to be self-checked at startup.

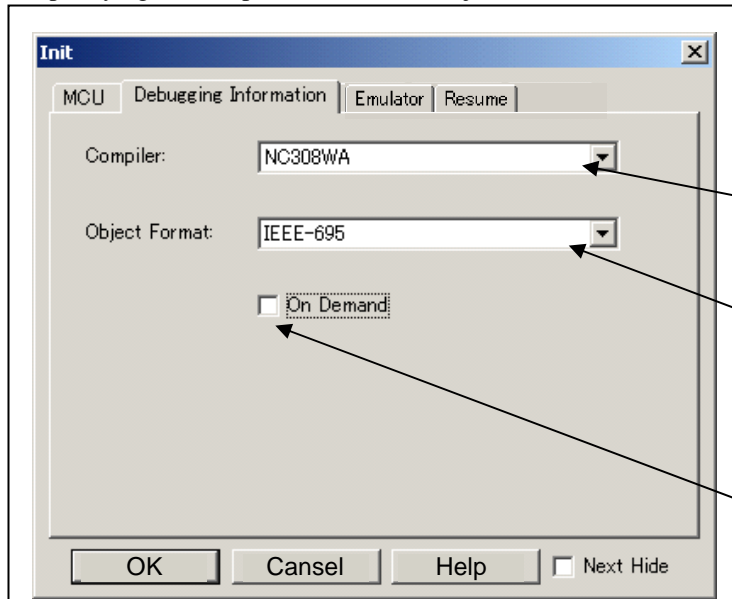
This function may be enabled in the following cases:

- When you are using the emulator you have just purchased
- When you fail to download the firmware
- When you successfully download the firmware, but fail to start up the emulator
- When you want to confirm whether the emulator is operating normally because, for example, the MCU runs out of control or something is wrong with the trace results

This function can be enabled only when you are starting up the emulator debugger.

(2) Debugging Information tab

1. Specifying the compiler used and the object format

Specifying the compiler used and the object format

Specify the compiler you are using and the format of the object file output by the compiler.

- Compiler

Select the compiler you are using.

(By default, the C compiler from Renesas is selected.)

- Object Format

Select the format of the object file that is output by the compiler you are using.

Specifying the method for storing debug information

There are two methods for storing debug information: on-memory method where data is held in memory and an on-demand method where data is held in a temporary file.

- On Memory

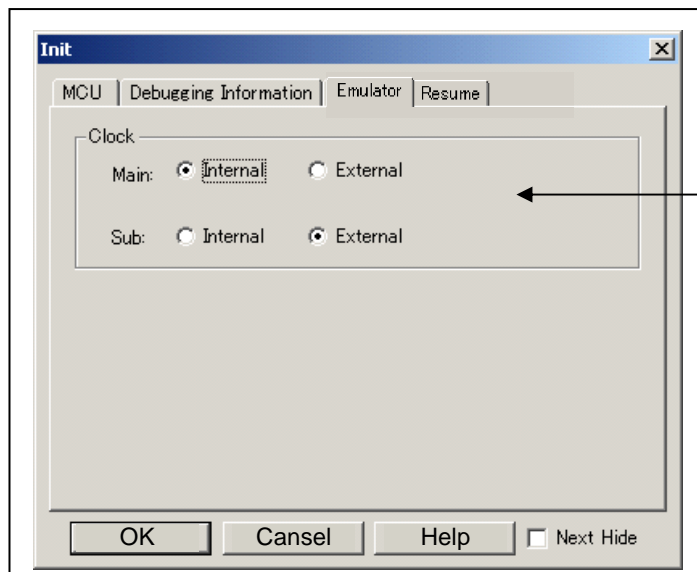
This method helps to speed up processing if your computer has sufficient memory.

- On Demand

This method helps to reduce the amount of memory needed. To use this method, select the "On Demand" check box.

(3) Emulator tab

1. Specifying the target clock

**Specifying the target clock**

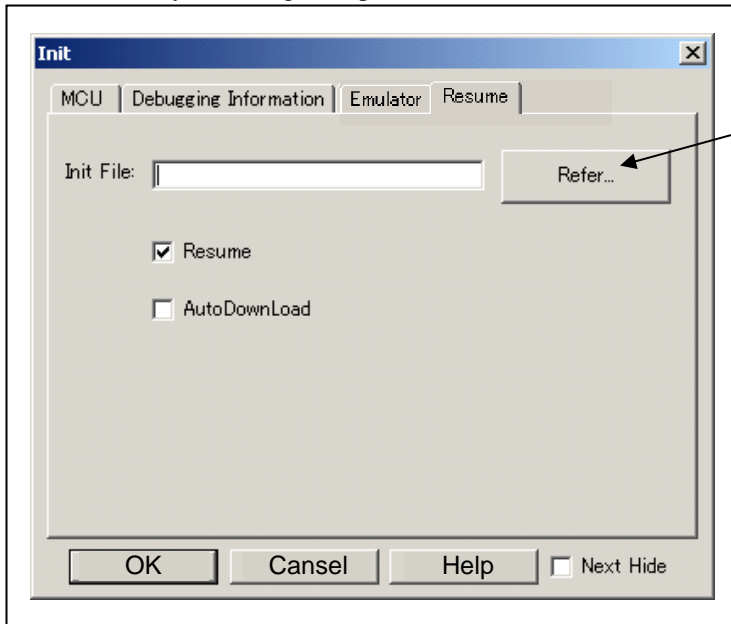
Specify the clock sources supplied to the MCU (main clock and sub clock). Select the appropriate clock sources according to the clock used by your target MCU.

- Internal
Emulator's internal clock
- External
User system clock

The option you have specified here remains effective the next time you start up.

(4) Resume tab

1. Automatically executing a script command

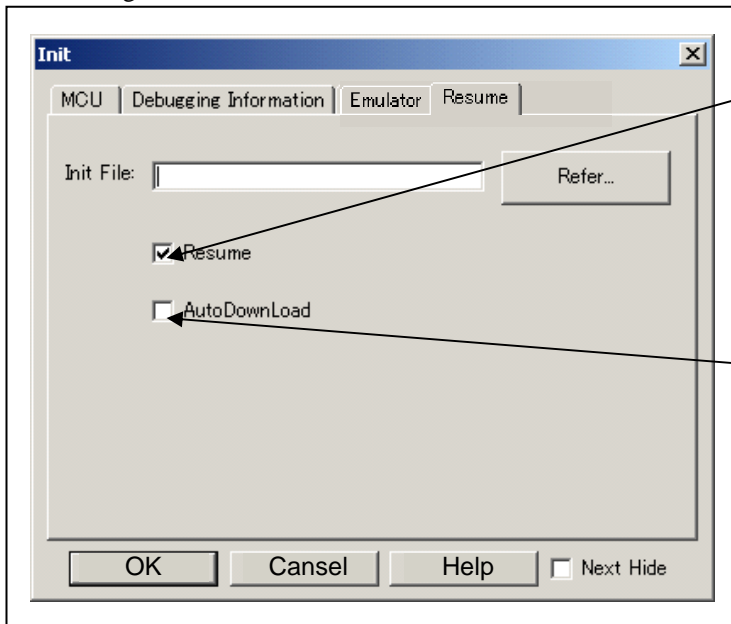


Automatically executing a script command
To automatically execute a script command when starting up the debugger, click the “Refer...” button and specify the script file to be executed.

Clicking the “Refer...” button brings up a file selection dialog box. The script file you have selected is displayed in the Init File: section of the dialog box shown here. If you do not want to automatically execute a script command, delete the character string displayed in the Init File: section of the dialog box.

What you specify here is reflected at only startup. If you specify back again in the Init dialog box after startup, whatever you specified has no effect. (Be sure to restart the emulator debugger.)

2. Restoring the last window state



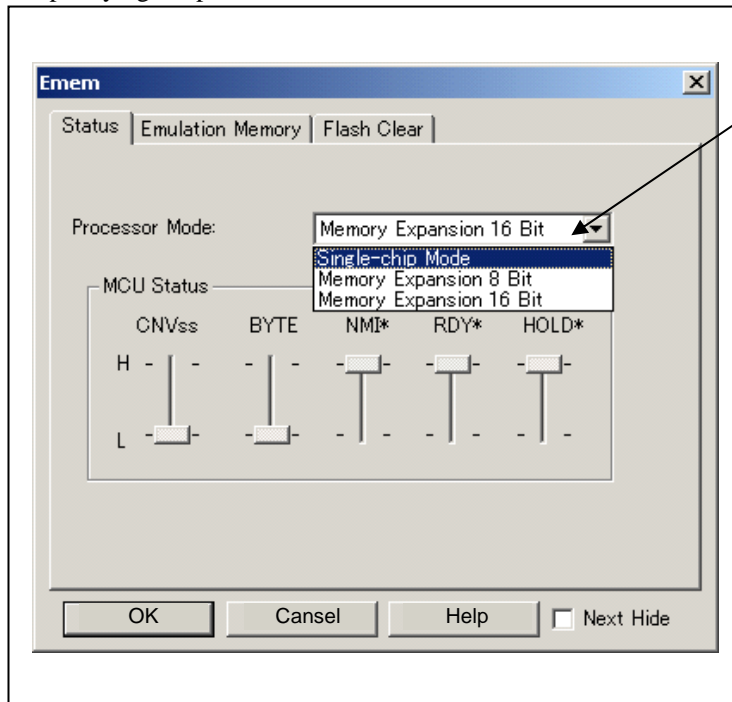
Restoring the last window state
To restore the window state (window position and window size) in which you last closed the debugger, select the “Resume” check box. (This check box is by default selected.)

Downloading the load module again
To download the load module (user program) again, select the “AutoDownLoad” check box. (This check box is by default deselected.)

3.2 Starting Up the Emulator Debugger (EMEM Dialog Box)

(1) STATUS tab

1. Specifying the processor mode



Specifying the processor mode

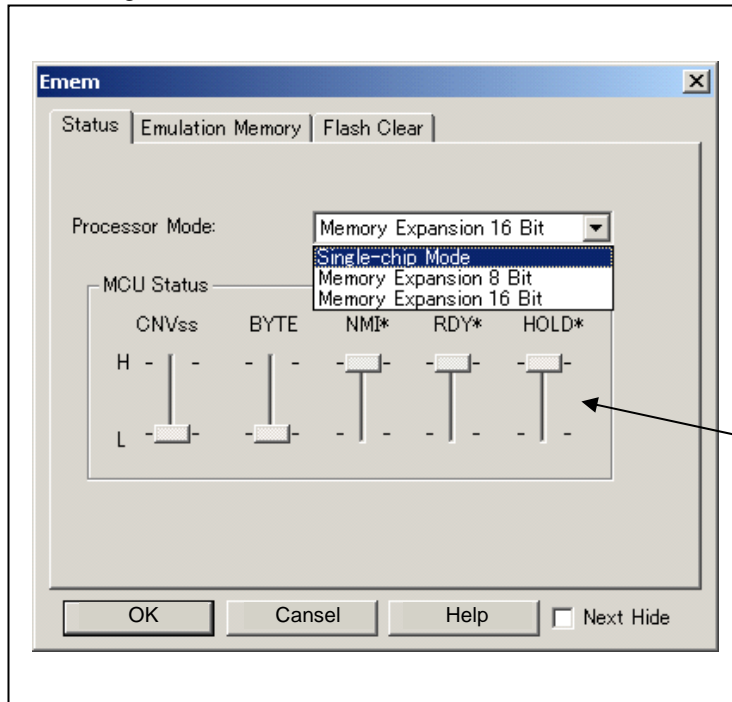
Select the appropriate processor mode that suits your system.

IMPORTANT

Notes on Selecting a Processor Mode:

- When setting single-chip mode or memory expansion mode, the level of pin CNVSS of the MCU status should be "L". The MCU status shows the pin level of the user system.
- When setting memory expansion mode, pins RDY* and HOLD* of the user system should be "H".
- When the user system is not connected, all modes are available.

1. Referring to the MCU Status

**Referring to the MCU Status**

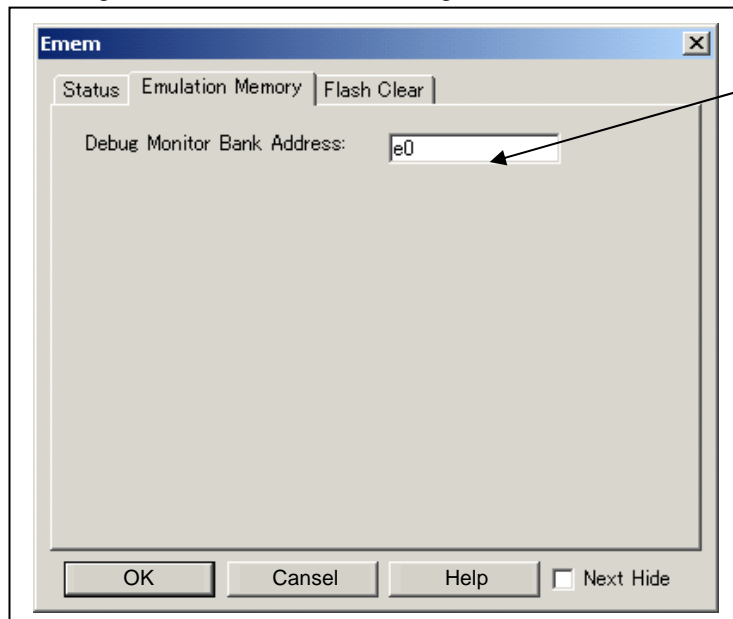
It shows the status of each MCU pin. Check it to see if the MCU status matches the selected processor mode. If a slider is at the center, it means that the pin status is indeterminate.

IMPORTANT**Notes on Selecting a Processor Mode:**

- The MCU status is shown in "MCU Status" of the EMEM dialog box. Check that it is matching the specified processor mode.
- Check that the RDY* and HOLD* are "H" level. If they are "L" level, as the MCU enters a wait status and the emulator debugger cannot receive the signal from the MCU, an error is displayed.

(2) Emulation Memory tab

1. Setting the Bank Address of the Debug Monitor

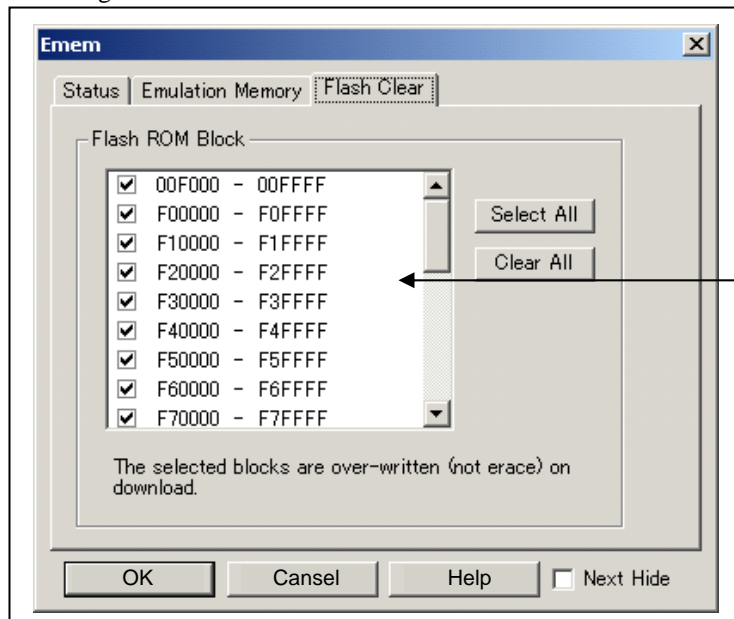
**Setting the Bank Address of the Debug Monitor**

The debug monitor uses contiguous 64 KB as a work area of the emulator. Specify the bank address of the debug monitor.

(e.g.: If E0 is specified, 64 KB area from D00000H address is used by the debug monitor)

(3) Flash Clear tab

1. Setting to clear the MCU's internal flash ROM

Setting to clear the MCU's internal flash ROM

Specify whether or not you want the MCU's internal flash ROM to be cleared when downloading the user program or data. (When cleared, the content of the flash ROM is initialized to 0xFF.) The MCU's internal flash ROM is listed in block units.

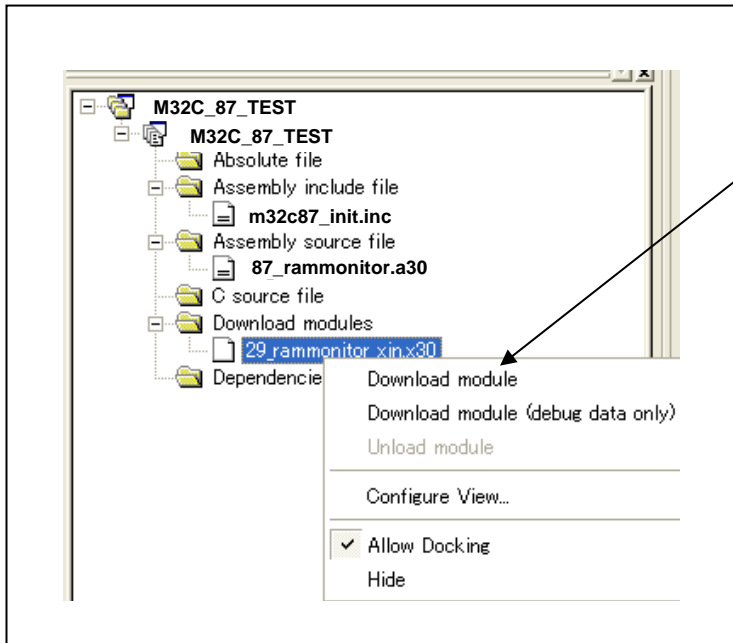
- Any block which has had its check box selected is not cleared when downloading. The memory content of this block remains intact unless overwritten by downloading.
- Any block which has had its check box deselected is cleared when downloading.
- Click the Select All button, and all blocks will be selected (marked by a check mark, so that none of the blocks is cleared when downloading).
- Click the Clear All button, and all blocks will be deselected (check marks removed, so that all of them are cleared when downloading).

The option you have specified here remains effective the next time you start up.

3.3 Program Window

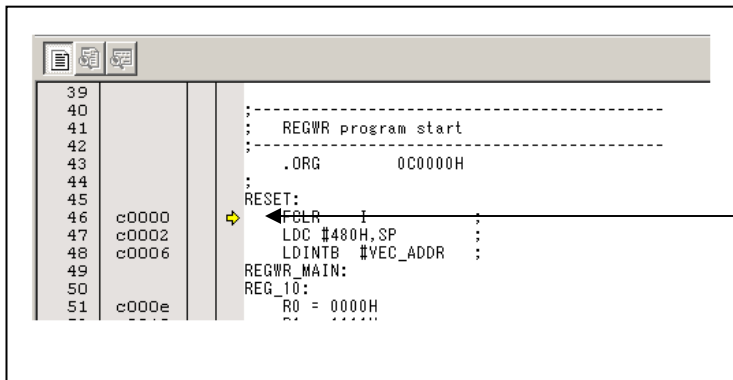
(1) Downloading the program

1. Downloading from the work space window



Downloading the program
Download the object program you want to debug.
Select Download from “xxx.x30” of “Download module”.
Or you can select “Download” from the “Debug” menu for the same effect.

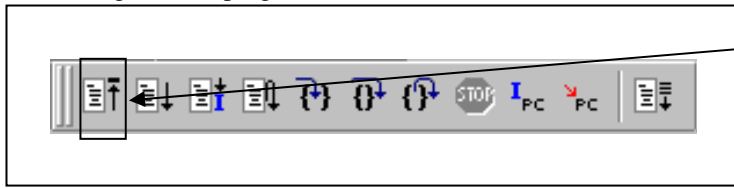
2. Showing the source program



Editor (source) window
The editor (source) window is a window that always shows the content of the source file corresponding to the current position of the program counter.
The program counter position is marked by a yellow arrow. Here, you can execute the program up to the cursor position, and set or clear software breakpoints.
Because the present emulator uses the MCU's internal flash ROM, the initial value for the ROM area data at the time of purchase is “FFh.”

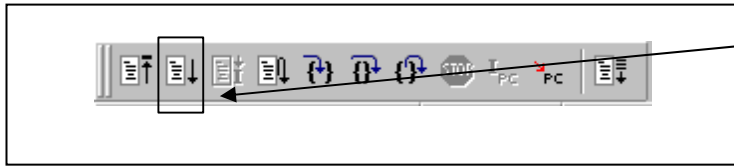
(2) Program execution

1 Resetting the user program



CPU reset
 Resets the target MCU.
 Or you can select "CPU Reset" from "Debug" menu for the same effect.

2 Executing the user program (Go)



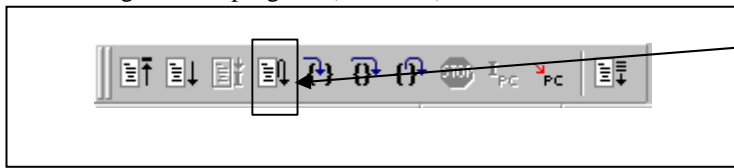
Go
 Runs the program beginning with the current PC position.
 Or you can select "Go" from "Debug" menu for the same effect.

3 Executing the user program (Go Free)



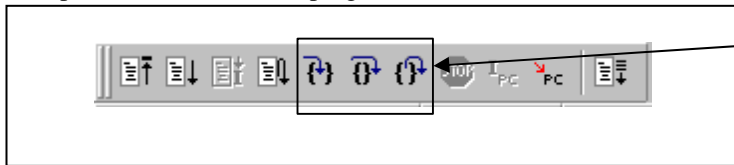
Go Free
 Runs the program beginning with the current PC position.
 The software and hardware breaks set in it are ignored.

4 Executing the user program (Reset Go)



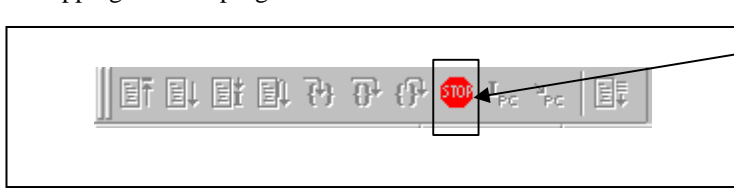
Reset Go
 Runs the program after reset.
 Or you can select "Reset Go" from "Debug" menu for the same effect.

5 Step execution of the user program



Step In
 Single-steps the program executing each statement (including those in functions).
Step Over
 Single-steps the program executing each function call as one step.
Step Out
 Exits a function and stops at a statement in the program next to the one that called the function.
 Or you can select "Step In" or other corresponding commands from "Debug" menu for the same effect.

6 Stopping the user program



STOP
 Stops the program.
 Or you can select "Stop" from "Debug" menu for the same effect.

7 Editor (Source) window after you have stopped the user program

```

F0118 6A09          JEQ      F0122H
F011A 75A1          LDE.W  [ATA0],R1
F011C B2           INC.W  A0
F011D B2           INC.W  A0
F011E C923          ADD.W  #2H,R3
F0120 FEF3          JMP.B  F0114H
F0122 F3           RTS
F0123 D902          sw_wait MOV.W  #0H,R2
F0125 77820F00      CMP.W  #000FH,R2
    
```

Editor (Source) window
 The position at which the user program has stopped is marked by a yellow arrow.

(3) Setting breakpoints

1. Screen after breakpoint setup

```

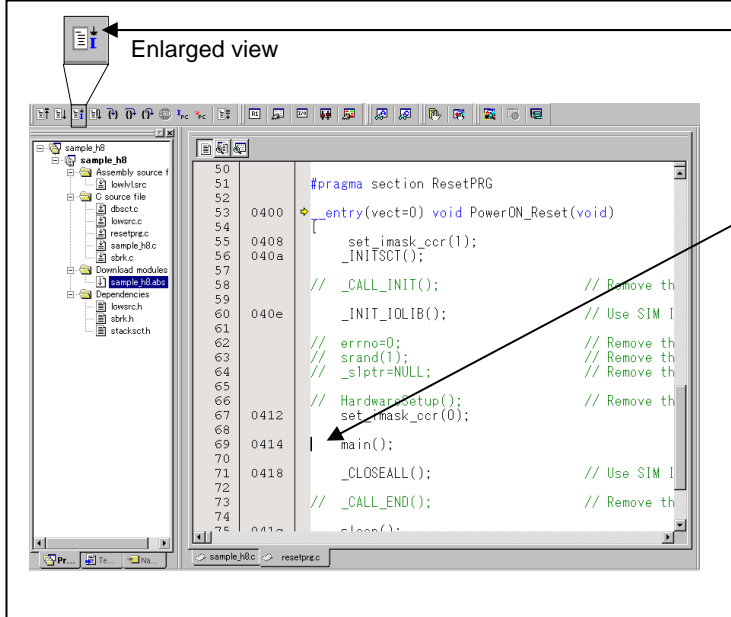
63          N_BZERO .macro TOP_,SECT_
64          mov.b  #00H,R0L
65          mov.w  #((TOP_ & 0FFFFH), A1
66          mov.w  #sizeof SECT_ , R3
67          sstr.b
68          .endm
69
70          N_BCOPY .macro FROM_,TO_,SECT_
71          mov.w  #((FROM_ & 0FFFFH),A0
72          mov.b  #((FROM_ >>16),R1H
73          mov.w  #TO_ ,A1
74          mov.w  #sizeof SECT_ , R3
75          smovf.b
76          .endm
77
78          BZERO .macro TOP_,SECT_
79          push.w #sizeof SECT_ >> 16
80          push.w #sizeof SECT_ & 0ffffh
81          pusha TOP_ >>16
82          pusha TOP_ & 0ffffh
83
    
```

Screen after breakpoint setup
 There are three types of breakpoints as described below.

- Address match breakpoint
 This breakpoint can be set only when you chose to use the address match break function on the MCU tab of the Init dialog box.
 A breakpoint can be set or cleared by double-clicking in the address match breakpoint display area in the editor (source) window. (A blue circle is displayed at the setting line)
 Up to eight breakpoints can be set.
 The address match break causes the program to stop before executing the address at which a breakpoint is set.
- Software breakpoint
 A software breakpoint can be set or cleared by double-clicking the software breakpoint display area in the editor (source) window (A red circle is displayed at the setting line).
 This is rewritten to a break instruction, therefore, because of rewriting flash ROM, program execution starts with a delay of several seconds after setting ROM area.
 If the breakpoint you set is a software breakpoint, the program stops before executing the instruction at the set breakpoint.
- Hardware breakpoint
 A hardware breakpoint can be set or cleared by right-clicking the breakpoint display area.
 If the breakpoint you set is a hardware breakpoint, the program stops after executing the instruction at the set breakpoint (after several cycles).

(4) Executing up to the cursor position

1. Setup procedure for running the program up to the cursor position

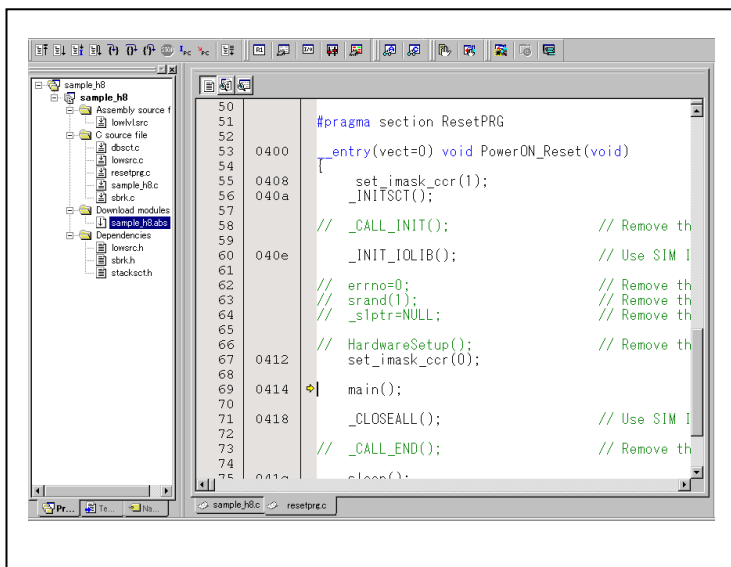


Setup procedure for running the program up to the cursor position

- (1) Click the line in the editor (source) window that you want to be executed.
- (2) Click the execution button to the cursor position.

Or you can select "Go to Cursor" from "Debug" menu for the same effect.

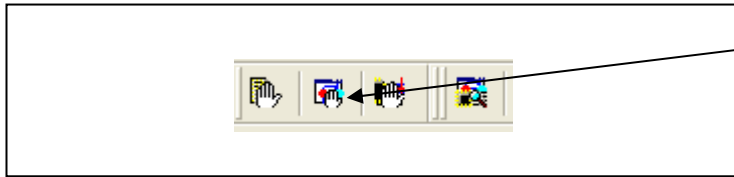
2. After the execution has finished



3.4 Hardware Breakpoint Setting Window

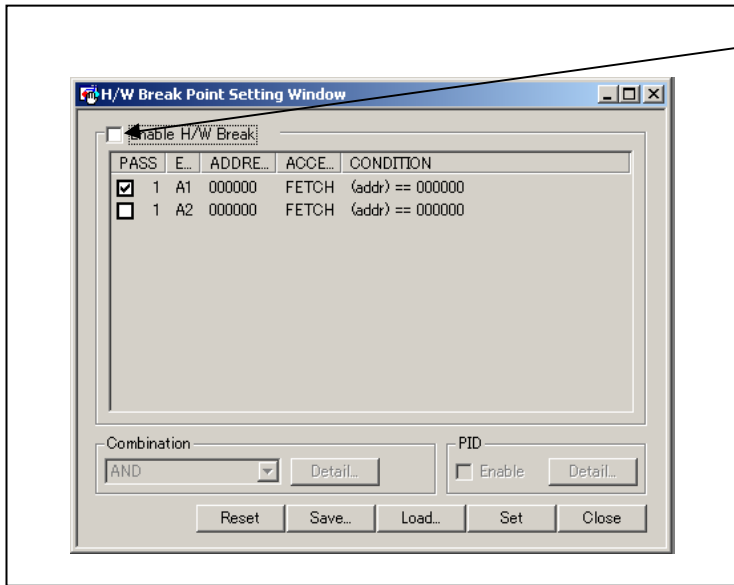
(1) Breakpoint setup dialog box

1. Opening the hardware breakpoint setup dialog box



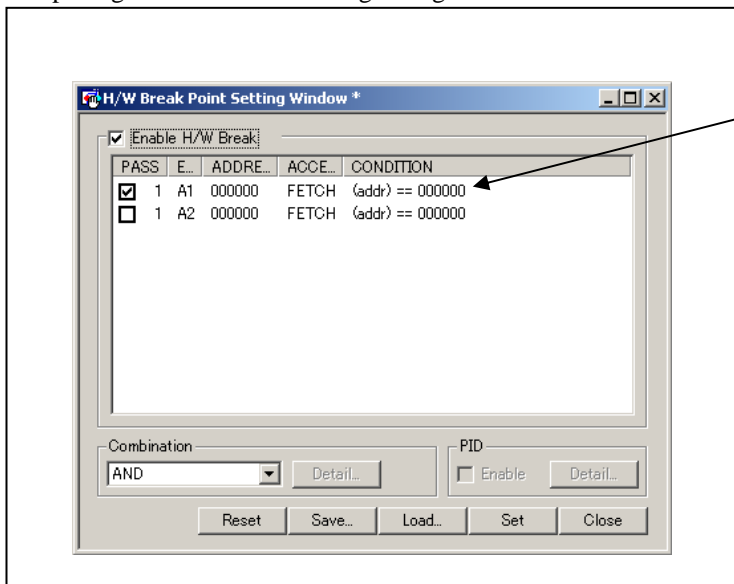
Hardware Break Point
Clicking this button opens the hardware breakpoint setup dialog box.

2. Hardware Break Point Setting Window in initial state



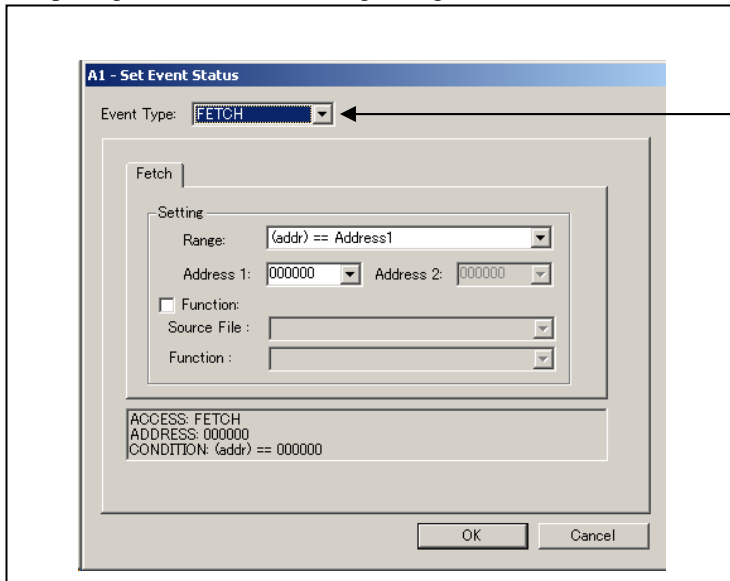
H/W breakpoint Setting Window in initial state
Select the "Enable H/W Break" check box, and this break function will be enabled, allowing you to set hardware breakpoints.

3. Opening the break event setting dialog box



Setting Break Event
Click the event line at which you want set a break event.

4. Opening the break event setting dialog box

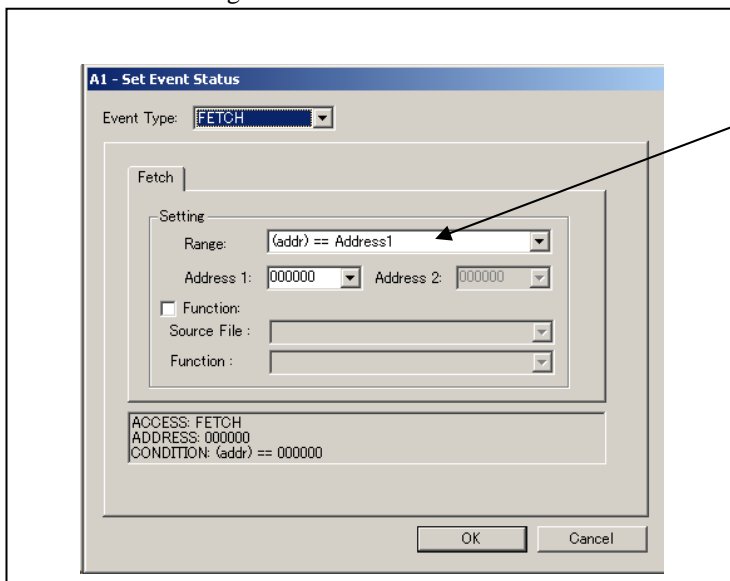
Specifying the event type

Click to select the event type you want to set.

- FETCH
Detects an instruction prefetch.
- DATA ACCESS
Detects a memory access.
- BIT SYMBOL
Detects a bit access.

(2) When FETCH is selected

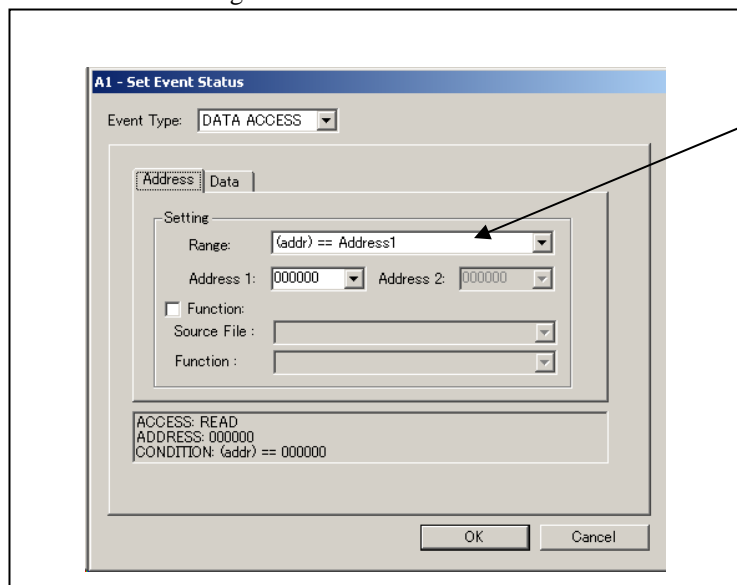
1. Window for setting addresses

Setting the address

You can set eight conditions, e.g., a specified address, a specified address range, etc. When you have finished setting the address, click OK.

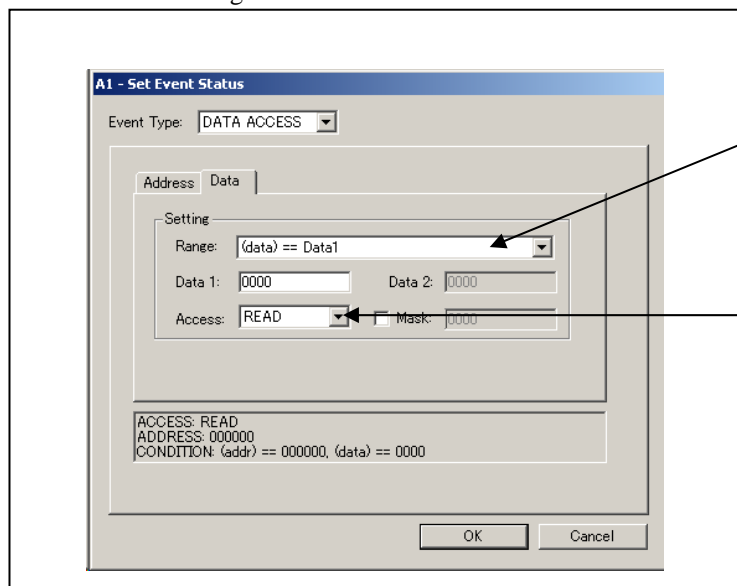
(3) When DATA ACCESS is selected

1. Window for setting the address



Setting the address
 You can set eight conditions, e.g., a specified address, a specified address range, etc.

2. Window for setting data



Setting data
 You can set two conditions, e.g., specified data or not to compare data.

Setting the access condition
 You can set three conditions, e.g., read, write, and read/write. When you have finished setting the data and access condition, click OK.

3. Example Data Settings

Event setting for even-address word access

MOV.W R0,512h(R0=0203h)

Cycle	Label	Address	Data	BUS	BHE	BIU	R/W	RWT	CPU
-00059		000512	0203	16b	0	DW	W	0	RW

High-order and low-order data effective

Event setting for odd-address word access

MOV.W R0,519h(R0=0203h)

Cycle	Label	Address	Data	BUS	BHE	BIU	R/W	RWT	CPU
-00026		000519	0302	16b	0	DW	W	0	CW
-00025		00051A	0302	16b	1	DW	W	0	--

Odd-address high-order data effective

Even-address low-order data effective

Event setting for even-address byte access

MOV.B R0L,516h(R0L=03h)

Cycle	Label	Address	Data	BUS	BHE	BIU	R/W	RWT	CPU
-00033		000516	0503	8b	1	BB	W	0	RW

Low-order data effective

Event setting for odd-address byte access

MOV.B R0L,515h(R0L=03h)

Cycle	Label	Address	Data	BUS	BHE	BIU	R/W	RWT	CPU
-00046		000515	0315	8b	0	BB	W	0	RW

High-order data effective

Setting a break event

A1

Address 1 :000512

Data 1 :0203

MASK :FFFF

Access :WRITE

Setting a break event (using 2 events)

A1

A2

Address 1 :000519 Address 1 :00051A

Data 1 :0300 Data 1 :0002

MASK :FF00 MASK :00FF

Access :WRITE Access :WRITE

Set the combinatorial events to AND.

Setting a break event

A1

Address 1 :000516

Data 1 :0003

MASK :00FF

Access :WRITE

Setting a break event

A1

Address 1 :000515

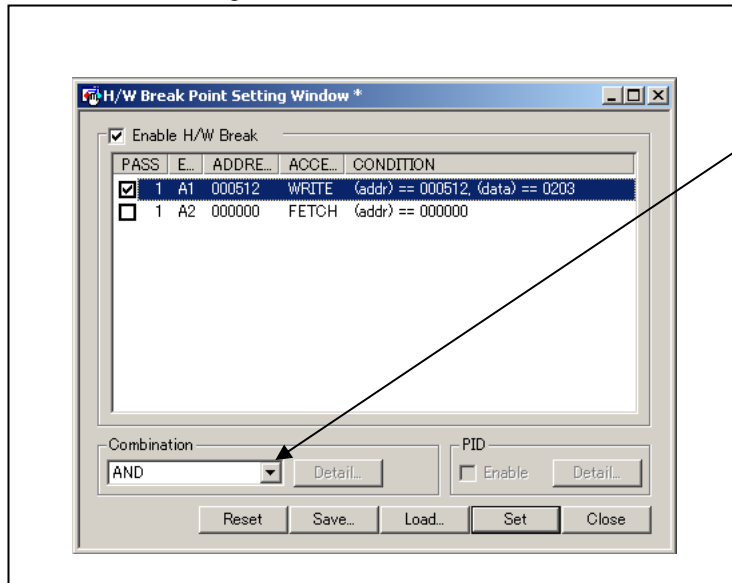
Data 1 :0300

MASK :FF00

Access :WRITE

(4) Setting the combinatorial event condition

1. Window for setting the combinatorial event condition

Setting the combinatorial event condition

There are following three conditions that you can choose for the combinatorial events.

- OR

The program breaks when one of the specified events occurs.

- AND

The program breaks when all of the specified events occur.

- AND (Same Time)

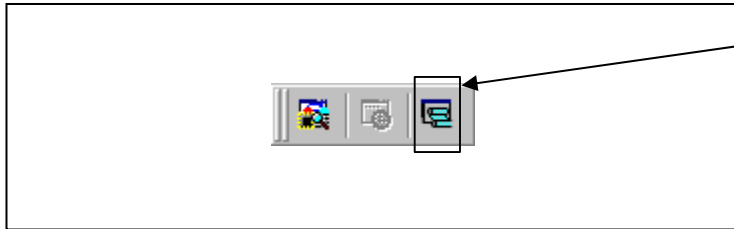
The program breaks when the specified events occur at the same time.

When you have finished setting the combinatorial event condition, click the "Set" button.

3.5 Trace Window

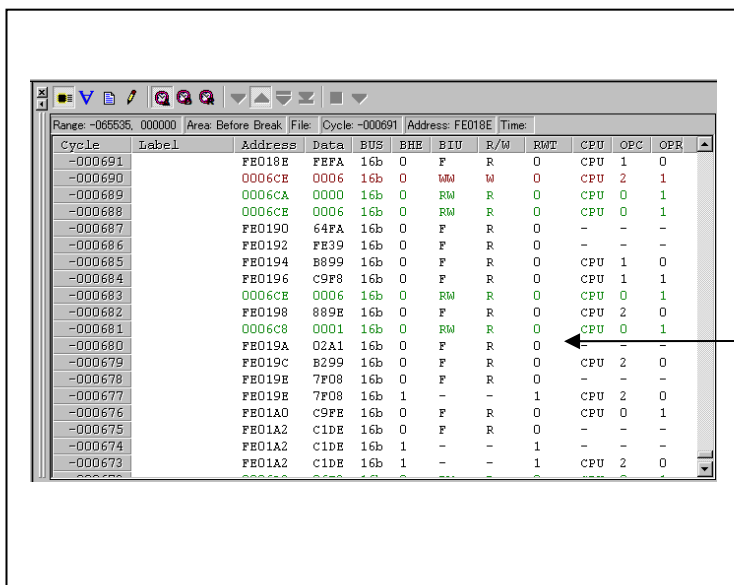
(1) Trace window

1. Opening the trace window



Trace window
 Clicking this button opens the trace window.

Or you can select "Trace" from "Trace" of "Display" menu for the same effect.



Trace window

The trace window is used to show the results of real-time trace measurements. It has the following four display modes:

- Bus mode
 Bus information per cycle can be inspected. The contents are displayed in order of execution paths.
- Disassemble + data access mixed mode
 The executed instruction and the content of the accessed data can be inspected together. Contents are displayed in order of the execution paths.
- Disassemble mode
 The execution paths of the executed instructions can be inspected. The contents are displayed in order of execution paths.
- Source mode
 The execution paths of the source program can be inspected.

These modes can be switched over using the respective toolbar buttons.

The trace window shows the measurement result when a real-time trace measurement has finished. The trace window remains blank until the real-time trace measurement in progress finishes.

2. Trace window (bus display)

Bus display

Cycle	Label	Address	Data	BUS	BHE	BIU	R/W	RWT	CPU	OPC	OPR
-000691		FE018E	FEFA	16b	0	F	R	0	CPU 1	0	
-000690		0006CE	0006	16b	0	WW	W	0	CPU 2	1	
-000689		0006CA	0000	16b	0	RW	R	0	CPU 0	1	
-000688		0006CE	0006	16b	0	RW	R	0	CPU 0	1	
-000687		FE0190	64FA	16b	0	F	R	0	-	-	-
-000686		FE0192	FE39	16b	0	F	R	0	-	-	-
-000685		FE0194	B899	16b	0	F	R	0	CPU 1	0	
-000684		FE0196	C9F8	16b	0	F	R	0	CPU 1	1	
-000683		0006CE	0006	16b	0	RW	R	0	CPU 0	1	
-000682		FE0198	889E	16b	0	F	R	0	CPU 2	0	
-000681		0006C8	0001	16b	0	RW	R	0	CPU 0	1	
-000680		FE019A	02A1	16b	0	F	R	0	-	-	-
-000679		FE019C	B299	16b	0	F	R	0	CPU 2	0	
-000678		FE019E	7F08	16b	0	F	R	0	-	-	-
-000677		FE019E	7F08	16b	1	-	-	1	CPU 2	0	
-000676		FE01A0	C9FE	16b	0	F	R	0	CPU 0	1	
-000675		FE01A2	C1DE	16b	0	F	R	0	-	-	-
-000674		FE01A2	C1DE	16b	1	-	-	1	-	-	-
-000673		FE01A2	C1DE	16b	1	-	-	1	CPU 2	0	

Explanation of the trace window (bus display)

The following explains the displayed contents, from left to right.

- Address
Shows the status of the address bus.
 - Data
Shows the status of the data bus.
 - BUS
Shows the width of the external data bus. In the present emulator, only "16b" for 16 bits wide bus is displayed.
 - BHE*
Shows the status (0 or 1) of the BHE (Byte High Enable) signal. If this signal = 0, the odd-address data is valid.
 - BIU
Shows the status between the BIU (Bus Interface Unit) and memory or I/O.
- Symbol Status
- : No change
 - WAIT : Executing the wait instruction
 - RBML : Read (bytes) ML on
 - F : Fetch
 - QC : Discontinuous fetch
 - RWML : Read (words) ML on
 - INT : Interrupt acknowledge cycle
 - RB : Read (bytes)
 - WB : Write (bytes)
 - DRB : Read (bytes) by DMA
 - DWB : Write (bytes) by DMA
 - RW : Read (words)
 - WW : Write (words)
 - DRW : Read (words) by DMA
 - DWW : Write (words) by DMA
- R/W
Shows the status of the data bus.
Displayed as "R" for Read, "W" for Write, and "-" for no access.
 - RWT
This is the signal to indicate a valid bus cycle. When valid, RWT = 0. The Address, Data, and the BIU signals are effective when this signal is 0.
 - CPU
Shows the status between the CPU and BIU (Bus Interface Unit).
 - OPC
Shows the op-code size in the read data.
 - OPR
Shows the code size except op-code.

Disassemble display

Cycle	Address	Obj-code	Label	Mnemonic	h' r'
-000691	FE018C	93F6FAFE		CMP.W	-6H[FB], -2H[FB]
-000686	FE0190	FA64		JLT	FE01F5H
-000685	FE0192	39FE		MOV.W	-2H[FB], R0
-000683	FE0194	99B8F8		ADD.W	-8H[FB], R0
-000680	FE0197	C99E		EXTS.W	R0
-000678	FE0199	88A102		SHLW.L	#2H, R2R0
-000674	FE019C	99B208		ADD.L	8H[FB], R2R0
-000670	FE019F	7FFE		MOV.W	-2H[FB], R1
-000667	FE01A1	C9DE		EXTS.W	R1
-000665	FE01A3	C1B3		MOV.L	R3R1, A0
-000663	FE01A5	80A102		SHLW.L	#2H, A0
-000659	FE01A8	91B208		ADD.L	8H[FB], A0
-000655	FE01AB	C1E3		MOV.L	R2R0, A1
-000653	FE01AD	8111		CMP.L	[A1], [A0]
-000647	FE01AF	EB45		JLE	FE01F5H
-000643	FE01F5	93F8F8FC		ADD.W	-8H[FB], -4H[FB]
-000639	FE01F9	B885		JMP.B	FE017FH
-000636	FE017F	77FC0A00		CMP.W	#000AH, -4H[FB]

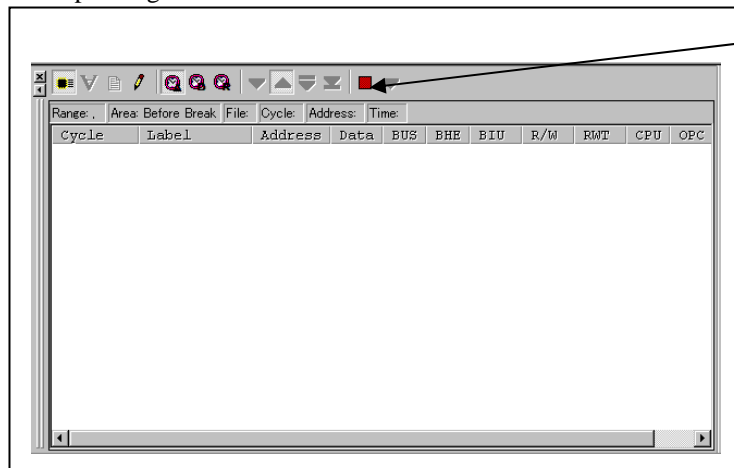
Source display

```

00023      sort(long *a)
00024      {
00025          long t;
00026          int i, j, k, gap;
00027
00028      FE0162      gap = 5;
00029      FE0165      while( gap > 0 ){
00030      FE016D          for( k=0; k<gap; k++){
00031      FE0178              for( i=k+gap; i<10; i=i+gap ){
00032      FE0185                  for(j=i-gap; j>=k; j=j-gap){
00033      FE0192                      if(a[j]>a[j+gap]){
00034      FE01B1                          t = a[j];
00035      FE01C0                              a[j] = a[j+
00036      FE01DD                                  a[j+gap] =
00037
00038
00039
00040                      }
00037                      }
00038                      else break;
00039
00040              }
00040          }
    
```

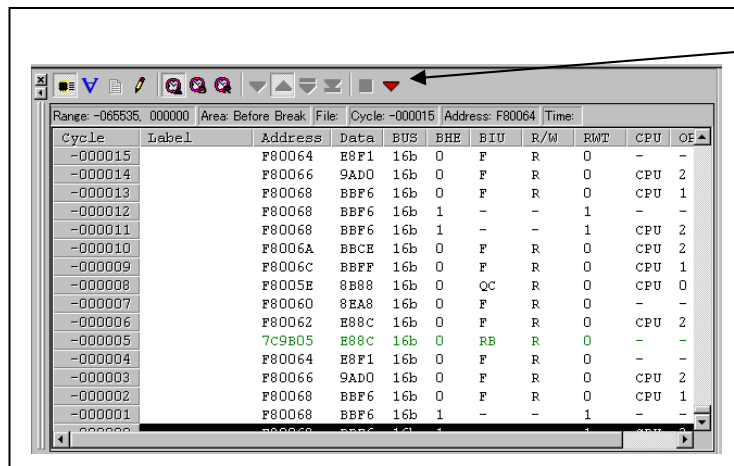
(2) Suspending and resuming trace measurement

1. Suspending trace measurement



Stop
Click this toolbar button to suspend the trace measurement in progress.

2. Resuming trace measurement



Re-Start
Click this toolbar button to resume the trace measurement in progress.

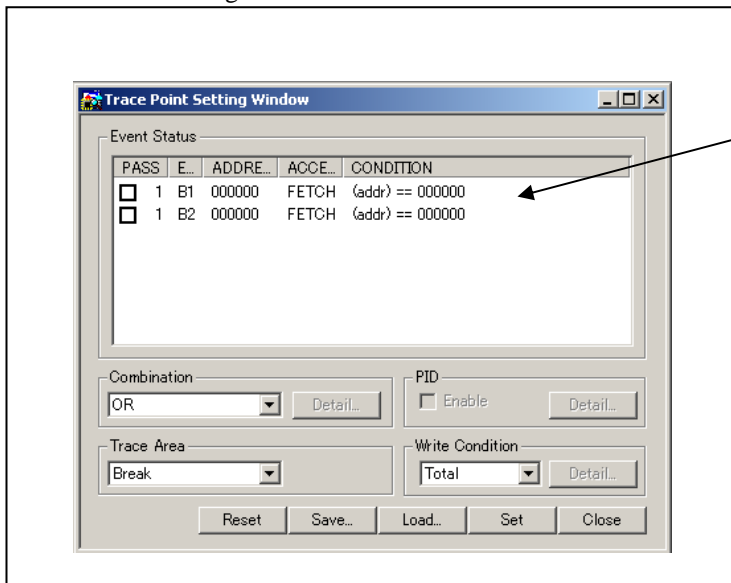
(3) Trace point setup window

1. Opening the trace point setup dialog box

**Trace Point**

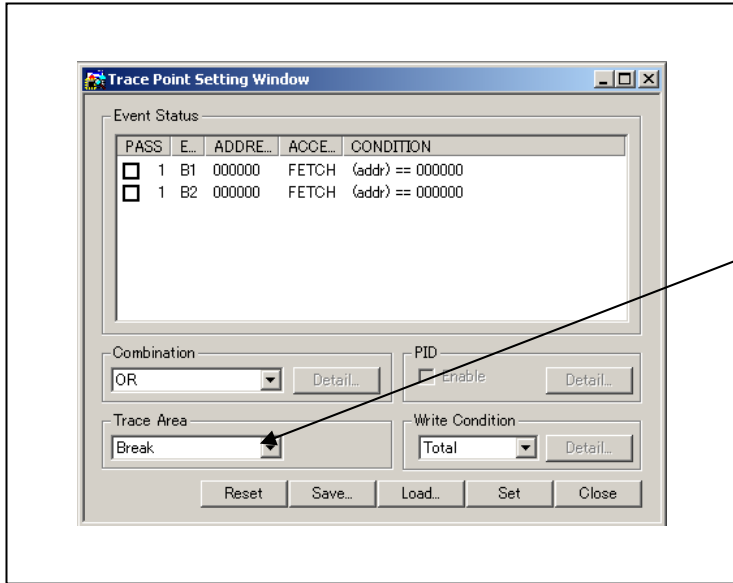
Clicking this toolbar button opens the trace point setting window.

2. Trace Point Setting Window in initial state

**Trace Point Setting Window in initial state**

Be sure to enable the trace point function in the Init dialog box before you set up in this window. Here, you can set events in the same way as for the hardware breakpoints.

3. Specifying a trace range

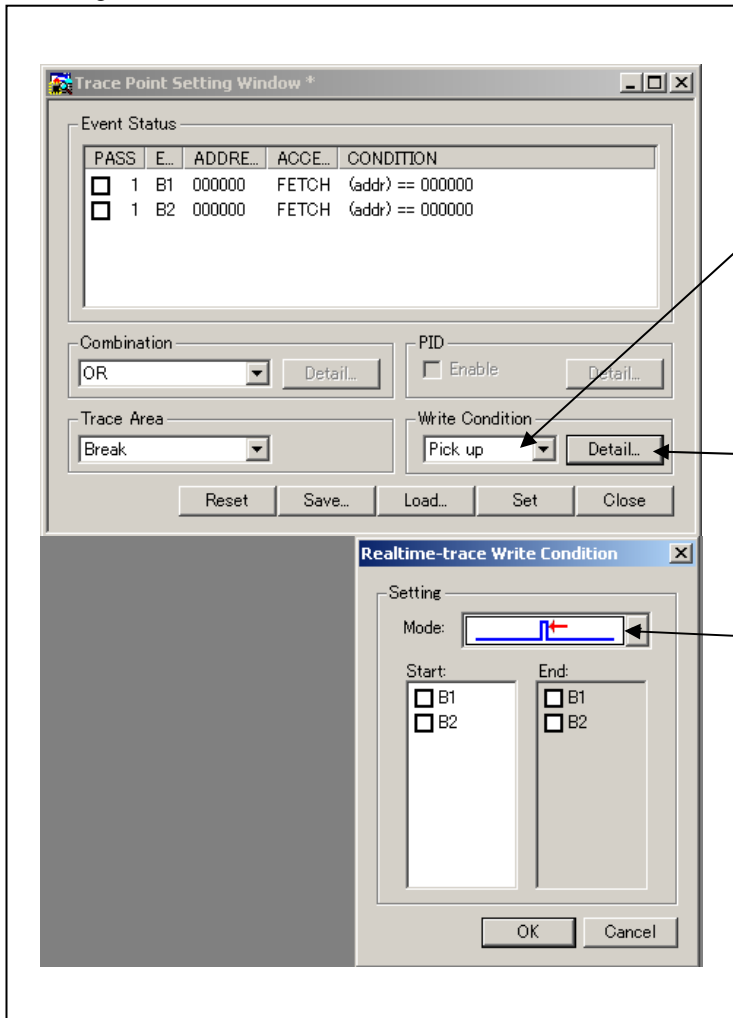


Specifying a trace range

You can specify a trace range for the trace event.

- Break
64K cycles of instruction execution before the user program stopped is recorded.
- Before
64K cycles of instruction execution before a trace point condition was met is recorded.
- About
64K cycles of instruction execution before and after a trace point condition was met is recorded.
- After
64K cycles of instruction execution after a trace point condition was met is recorded.
- Full
64K cycles of instruction execution after a trace began is recorded.

4. Setting the trace write condition



Setting the trace write condition

You can specify a condition for the cycles to be written into the trace memory.

- Total
All cycles are written into memory.
- Pick up
Only the cycles in which the specified condition was met are written into memory.
- Exclude
Only the cycles in which the specified condition was not met are written into memory.

When you have finished setting the trace write condition, click this button. The Realtime-trace Write Condition dialog box shown below will appear.

Write mode



Only the cycle in which the specified Start event occurred



A range of cycles from when the specified Start event occurred to when the specified Start event became nonexistent

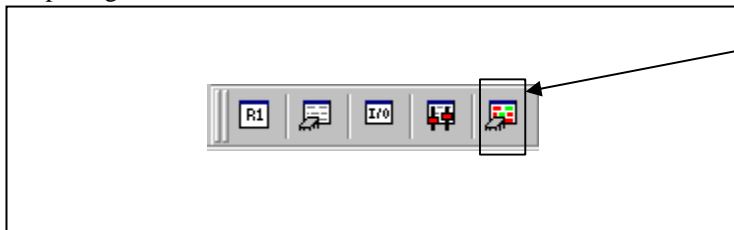


A range of cycles from when the specified Start event occurred to when the specified End event occurred

3.6 RAM Monitor Window

(1) RAM monitor window

1 Opening the RAM monitor window

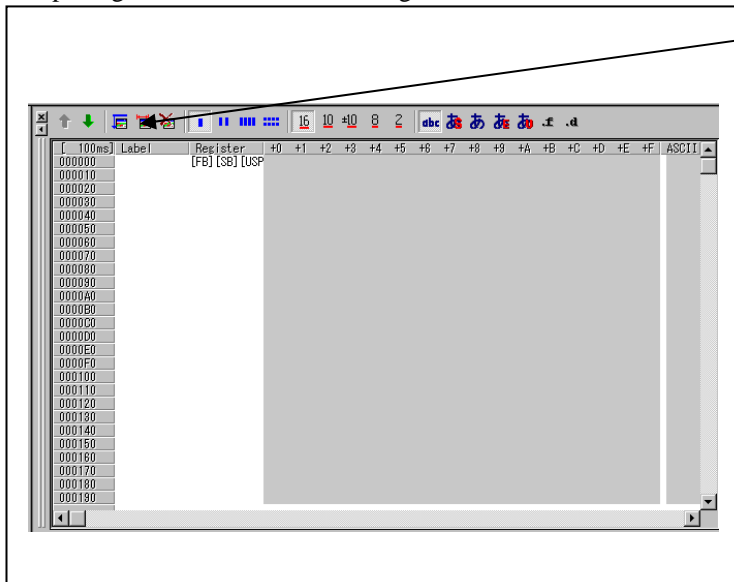


RAM monitor
Clicking this button opens the RAM monitor window.

Or you can select "RAM monitor" from "CPU" of "Display" menu for the same effect.

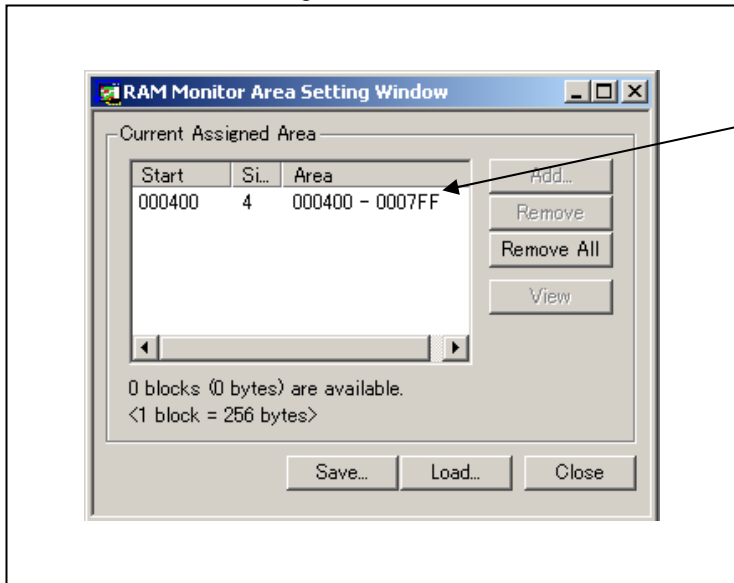
(2) RAM monitor area setting window

1. Opening RAM monitor area setting window



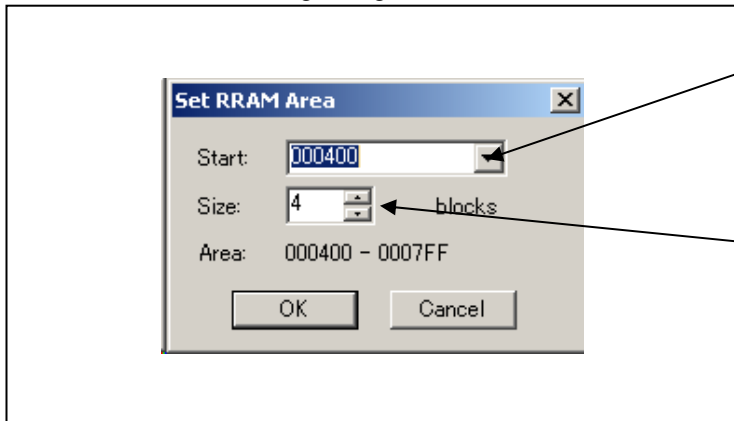
Base
Clicking this toolbar button opens the RAM monitor area setting window.

2. RAM monitor area setting window in initial state



RAM Monitor Area Setting Window in initial state
 By default, the monitor area is set to 000400h through 0007FFh. To change it, click the line you want to set.

3. RAM monitor area setting dialog box



Specifying the start address
 You can set the start address of the RAM area to be monitored.

Specifying the size
 You can set the size to be monitored by specifying the number of blocks from the start address. One block is 256 bytes in size.

4. Hardware Specifications

This chapter describes specifications of this product.

4.1 Target MCU Specifications

Table 4.1 lists the specifications of target MCUs which can be debugged with this product.

Table 4.1 Specifications of target MCUs for the M30870T2-CPE

Item	Description
Applicable MCU	M32C/87 Group
Applicable MCU mode	Single-chip mode, memory expansion mode
Maxi. ROM/RAM capacity	1. Internal flash ROM: 1024KB+4KB 0F000h--0FFFFh, F00000h--FFFFFFh 2. Internal RAM: 48KB 00400h--0C3FFh
Operating voltage/frequency*	VCC1=VCC2=4.2--5.5V: 32MHz VCC1=VCC2=3.0--5.5V: 24MHz

* If using this product when the voltage of VCC1 is higher than that of VCC2, the CPU clock must be 24 MHz or less.

4.2 Differences between the Actual MCU and Emulator

Differences between the actual MCU and emulator are shown below. When debugging the MCU using this product, be careful about the following precautions.

IMPORTANT

Notes on the User System (Power Supply, Order of Powering On):

- When the user system is connected, be sure to set the JP1 of the emulator to "EXT".
- This emulator cannot supply the power to the user system. Therefore design your system so that the user system is powered separately.
- This emulator consumes max. 500 mA of electric current from the user system.
- The voltage of the user system should be as follows.
 - (1) When JP1 of the M30870T-EPBM is set as $VCC1 = 2$:
 $3.0\text{ V} \leq VCC1 = VCC2 \leq 5.5\text{ V}$
 - (2) When JP1 of the M30870T-EPBM is set as $VCC1 > 2$:
 $4.8\text{ V} \leq VCC1 \leq 5.2\text{ V}$
 $3.0\text{ V} \leq VCC2 < VCC1$
- Do not change the voltage of the user system after turning on the power.

Notes on Using This Product When the Voltage of VCC1 is Higher than That of VCC2:

- If using this product when the voltage of VCC1 is higher than that of VCC2, set the JP1 of the M30870T-EPBM to $VCC1 > 2$. For the switch JP1, refer to "2.9.1 Setting Switches of Emulator " (page 40).
- If using this product when the voltage of VCC1 is higher than that of VCC2, the CPU clock must be 24 MHz or less.

Note on Intelligent I/O Resistor Access:

- If using a CPU clock of more than 24MHz, set the SFR area of the intelligent I/O function to 2-wait (set the PM13 bit to "1") when reading this area. This precaution only needs to be observed when using an emulator, and does not apply for the actual MCU.

IMPORTANT

Note on Differences between the Actual MCU and Emulator:

- Operations of the emulator system differ from those of actual MCUs as listed below.
 - (1) Reset condition
 - (2) Initial values of internal resource data of an MCU at power-on
 - (3) Interrupt stack pointer (ISP) after a reset is released
 - (4) Capacities of the internal memories (ROM and RAM)

The MCU whose RAM size is 48 KB (400h--C3FFh) is mounted on this product. The internal flash memory is automatically allocated to F000h--FFFFh and F00000h--FFFFFFh in the single-chip mode and memory expansion mode.
 - (5) Oscillator circuit
 - Make note of the fact that in the oscillator circuit where a resonator is connected between pins X_{IN} and X_{OUT} , oscillation does not occur because a converter board and other devices are used between the evaluation MCU and the user system. It is same for a sub-clock oscillator (X_{CIN} and X_{COUT}).
 - For notes on when using the oscillator circuit on the user system, refer to "2.9.2 Selecting Clock Supply" (page 47).
 - (6) A/D conversion

The characteristics of the A/D converter differ from those of actual MCU because there are a converter board and other devices between the evaluation MCU and the user system.
 - (7) Port P15

As one of I/O ports (P15) is connected to the user system through the analog switch circuit, electric characteristics slightly differ from those of an actual MCU.
 - (8) When the SW4 is set to XOUT in stop mode, a clock is output from the XOUT pin.

Note on RESET* Input:

- A low input to pin RESET* from the user system is accepted only when a user program is being executed (when the RUN status LED on the emulator's upper panel is lit).

Note on RDY* Input:

- Be sure to input "L" to pin RDY* of the user system during the user program executing (when the RUN status LED on the emulator's upper panel is lit). Inputting "L" to pin RDY* during the user program stopping may cause a malfunction of the emulator.

Note on HOLD* Input:

- Be sure to input "L" to pin HOLD* of the user system during the user program executing (when the RUN status LED on the emulator's upper panel is lit). Inputting "L" to pin HOLD* during the user program stopping may cause a malfunction of the emulator.

Note on NMI* Input:

- A low input to pin NMI* from the user system is accepted only when a user program is being executed (when the RUN status LED on the emulator's upper panel is lit).

IMPORTANT

Notes on Reset Vector Area:

- For a reset vector area, memory of the emulator is always selected regardless of the setting of the EMEM dialog box.
- A reset vector area can be changed only when a program is stopped.

Notes on Stack Area:

- With this product, a maximum 8 bytes of the user stack is consumed as a work area. Therefore, ensure the +8 byte maximum capacity used by the user program as the use stack area.
Even if the user stack does not have an enough area, do not use areas which cannot be used as a stack (SFR area, RAM area which stores data, or ROM area) as a work area. Using areas like this is a cause of user program crashes and destabilized emulator control.
- With this product, the interrupt stack pointer (ISP) is set at 00500h and used as a stack area after a reset is released.

Notes on Maskable Interrupts:

- Even if a user program is not being executed (including when run-time debugging is being performed), the evaluation MCU keeps running so as to control the emulator, so the function such as timer is operated. Take note that when the user program is not being executed (including when run-time debugging is being performed), a peripheral I/O interruption is not accepted.

Notes on Access Prohibited Area:

- The emulator control register (000020h--00003Fh) in the SFR is read-and write-protected. When this register is accessed, emulator control cannot be utilized.
- With this product, address FFFFFFFh cannot be read or written in correctly.

Note on DMA Transfer:

- With this product, the user program is stopped with a loop program to a specific address. Therefore, if a DMA request is generated by a timer or other source while the user program is stopped, DMA transfer is executed. However, make note of the fact that DMA transfer while the program is stopped may not be performed correctly. Also note that the below registers have been changed to generate DMA transfer as explained here even when the user program is stopped.
 - (1) DMA0 transfer count register DCT0
 - (2) DMA1 transfer count register DCT1
 - (3) DMA0 memory address register DMA0
 - (4) DMA1 memory address register DMA1
 - (5) DMA2 transfer count register DCT2 (R0)
 - (6) DMA3 transfer count register DCT3 (R1)
 - (7) DMA2 memory address register DMA2 (A0)
 - (8) DMA3 memory address register DMA3 (A1)

Note on DMAC II Transfer Completion Interrupts:

- You can use DMAC II transfer completion interrupts during program execution only. Do not generate DMAC II transfer completion interrupts when you use any function but program execution.

Note on Final Evaluation:

- Be sure to evaluate your system with an evaluation MCU. Before starting mask production, evaluate your system and make final confirmation with a CS (Commercial Sample) version MCU.

4.3 Connection Diagram

Figures 4.1, 4.2 and 4.3 show a part of the connection diagram of the M30870T2-CPE. Figures 4.1 and 4.2 show the connection diagrams using the M30870T-EPBM REV.B and M30870T-EPBM REV.C, respectively. These connection diagrams mainly show the interface section. The signals not shown in Figures 4.1, 4.2 and 4.3 connect the evaluation MCU and the user system directly. The circuits not connected to the user system such as the emulator's control system are omitted in Figures 4.1, 4.2 and 4.3. Table 4.2 shows IC electric characteristics of this product for reference purposes.

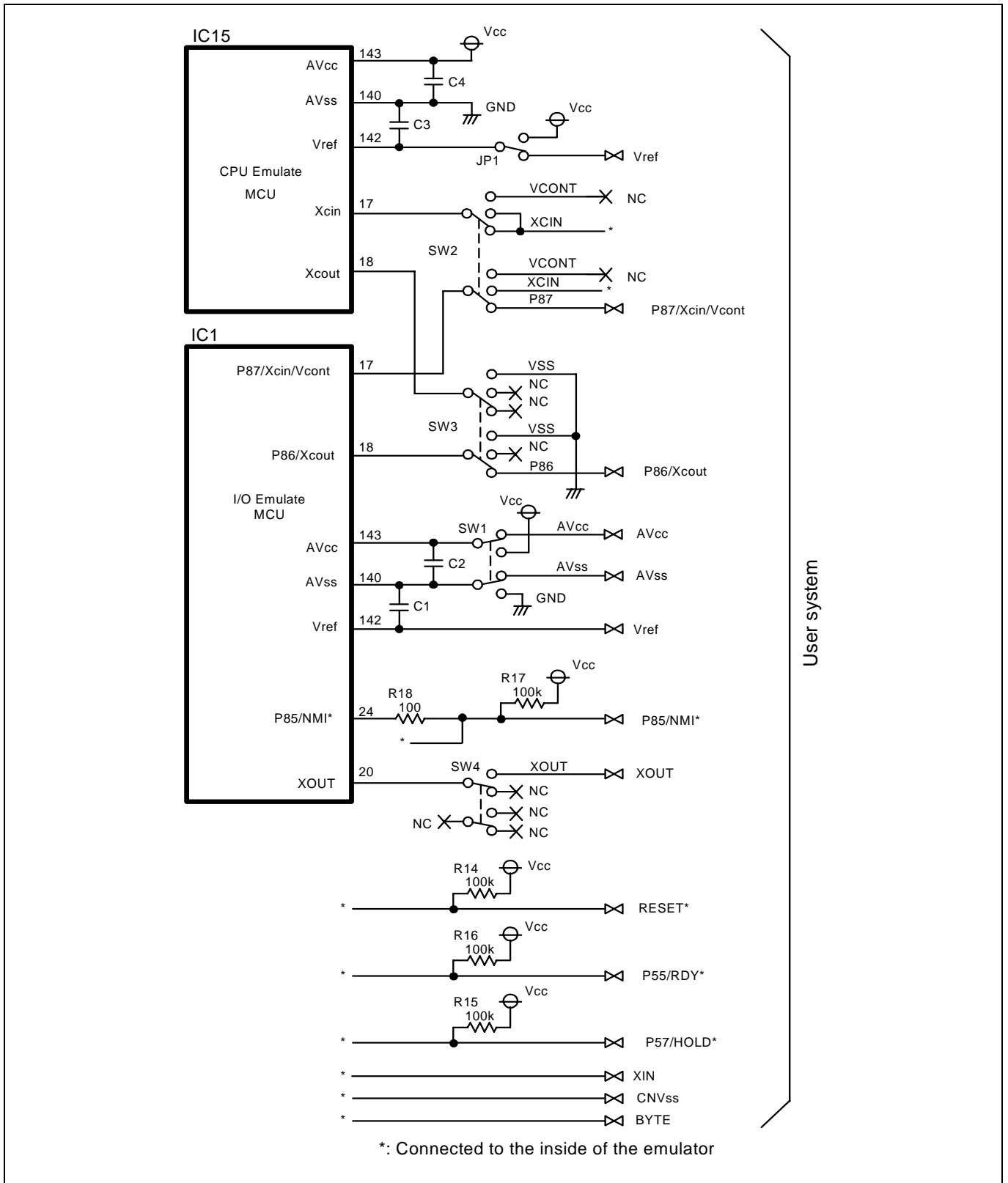


Figure 4.1 Connection diagram (when using M30870T-EPBM REV.B) (1/3)

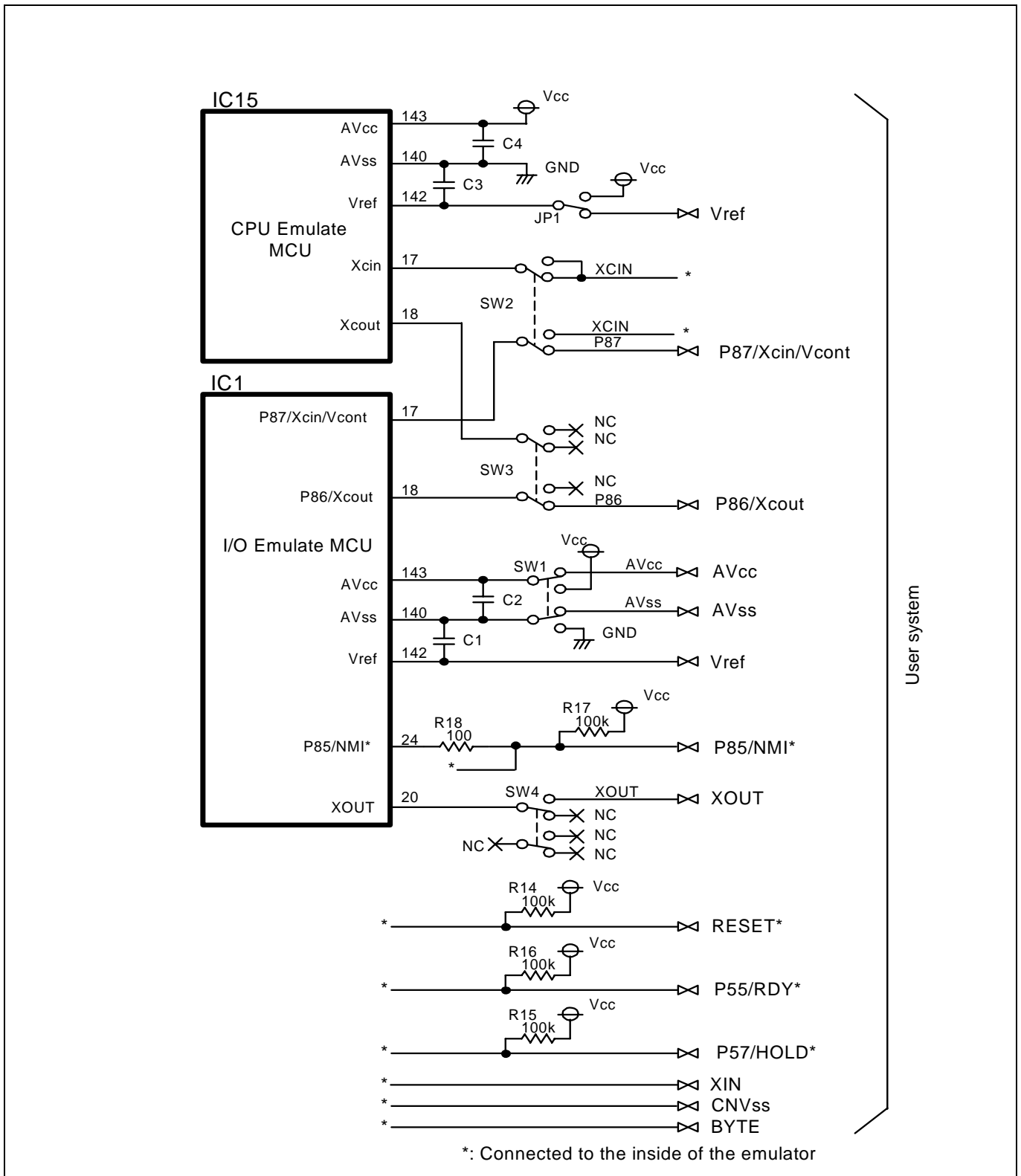


Figure 4.2 Connection diagram (when using M30870T-EPBM REV.C) (2/3)

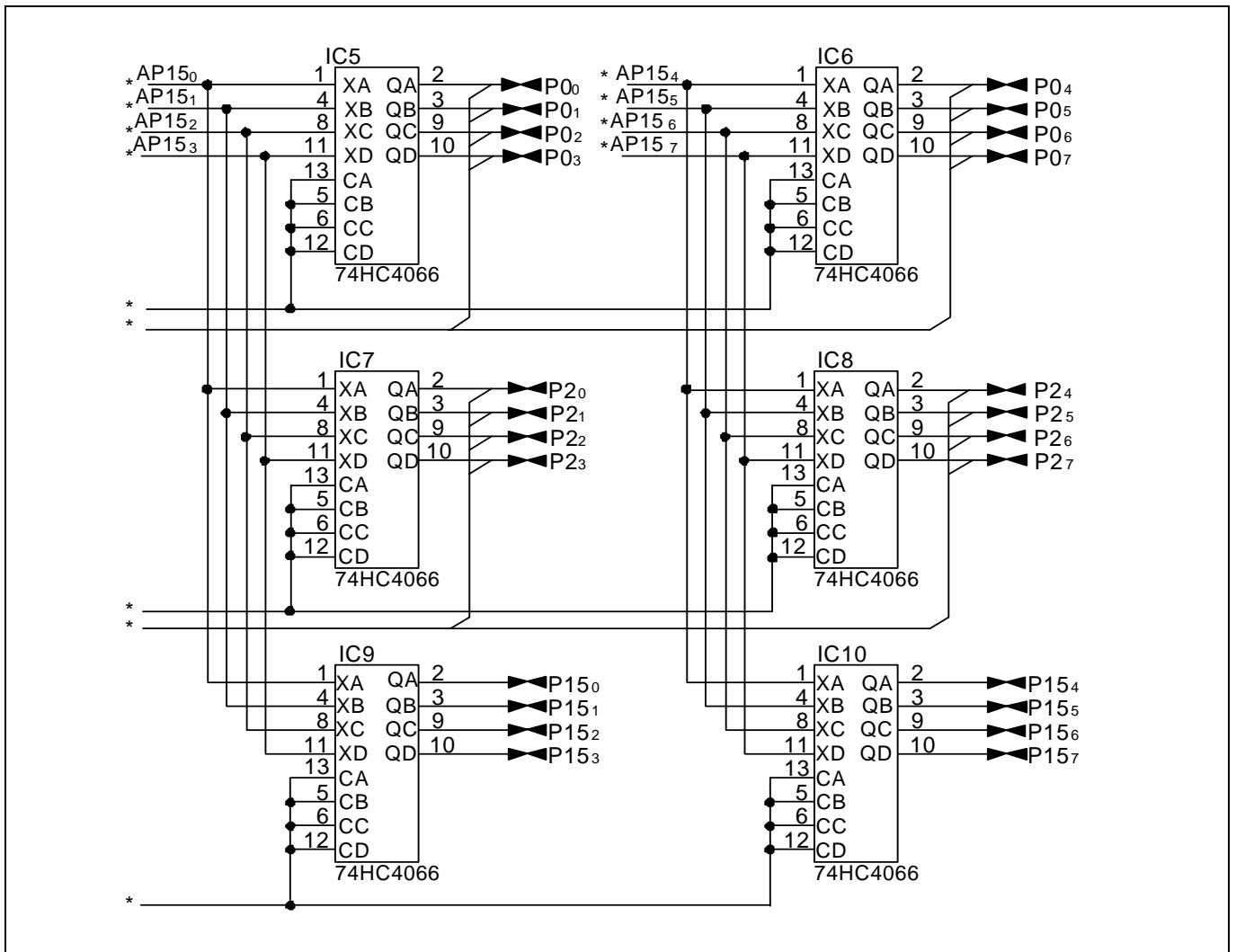


Figure 4.3 Connection diagram (3/3)

Table 4.2 Electrical characteristics of the 74HC4066

Symbol	Item	Condition	Standard values			Unit
		Vcc	Min.	Standard	Max.	
RON	ON resistor	2.0	-	160	-	Ω
		4.5	-	70	100	
ΔRON	ON resistor difference	4.5	-	10	-	
IN	Switch input leak current	12.0	-	-	±100	nA

4.4 External Dimensions

4.4.1 External Dimensions of the Compact Emulator

Figure 4.4 shows external dimensions of the M30870T2-CPE connected with the M30800T-PTC and LCC socket.

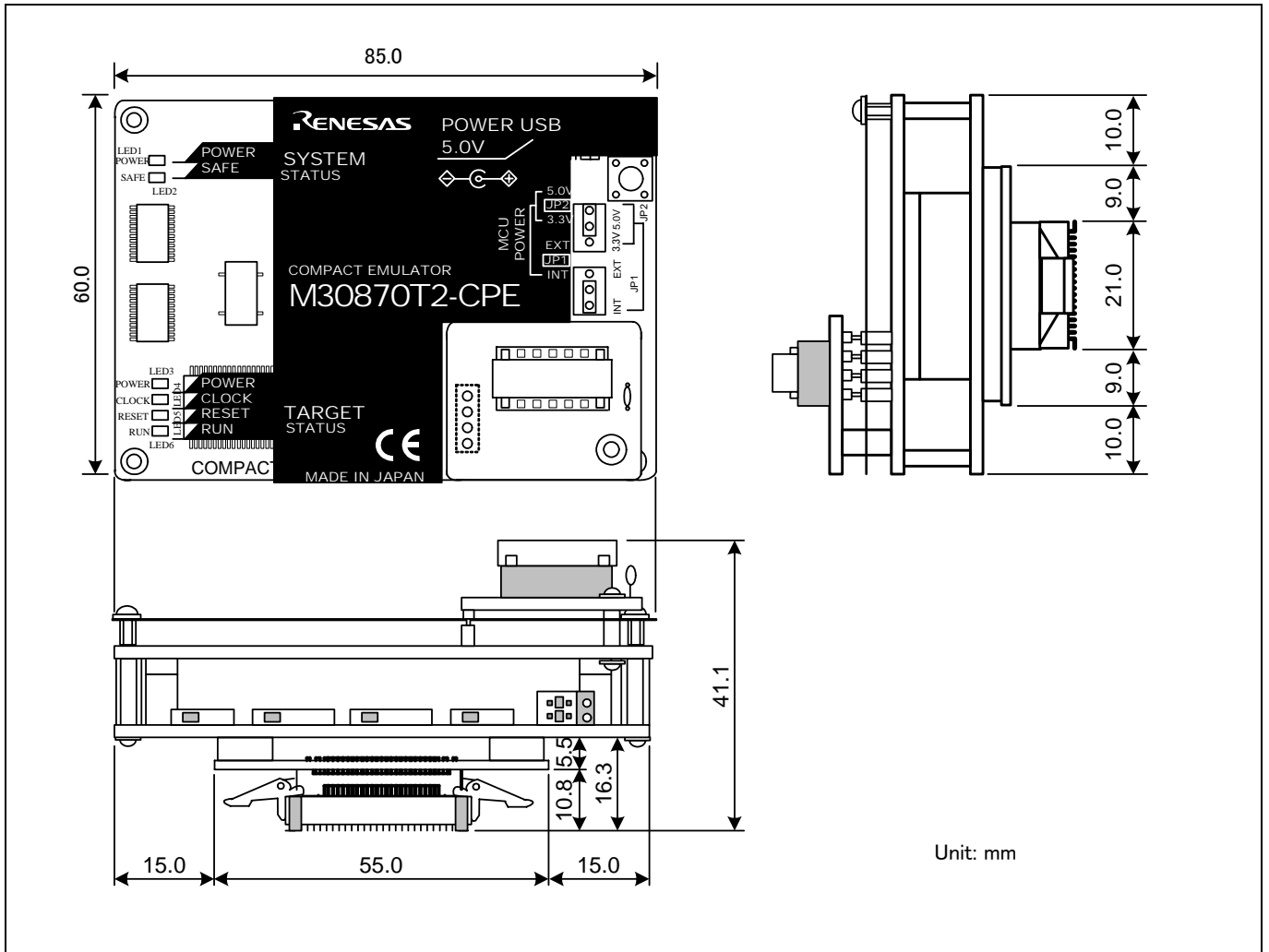


Figure 4.4 External dimensions of the compact emulator

4.4.2 External Dimensions of the M30800T-PTC

Figure 4.5 shows external dimensions of the converter board M30800T-PTC for a 100-pin QFP (100P6S).

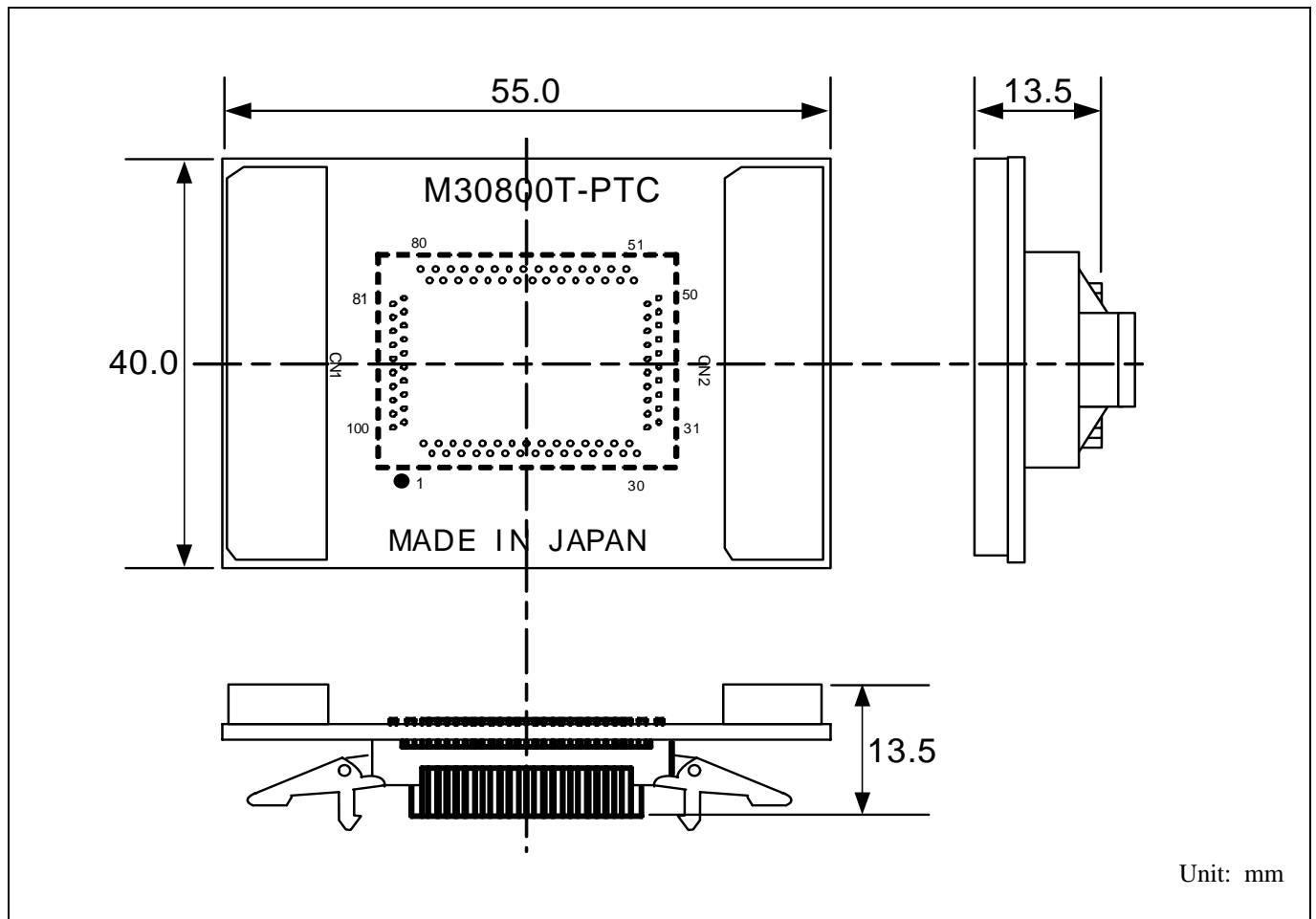


Figure 4.5 External dimensions of the M30800T-PTC

4.4.3 External Dimensions of the M3T-F160-100NSD

Figure 4.6 shows external dimensions of the converter board M3T-F160-100NSD for a 100-pin LQFP (100P6Q).

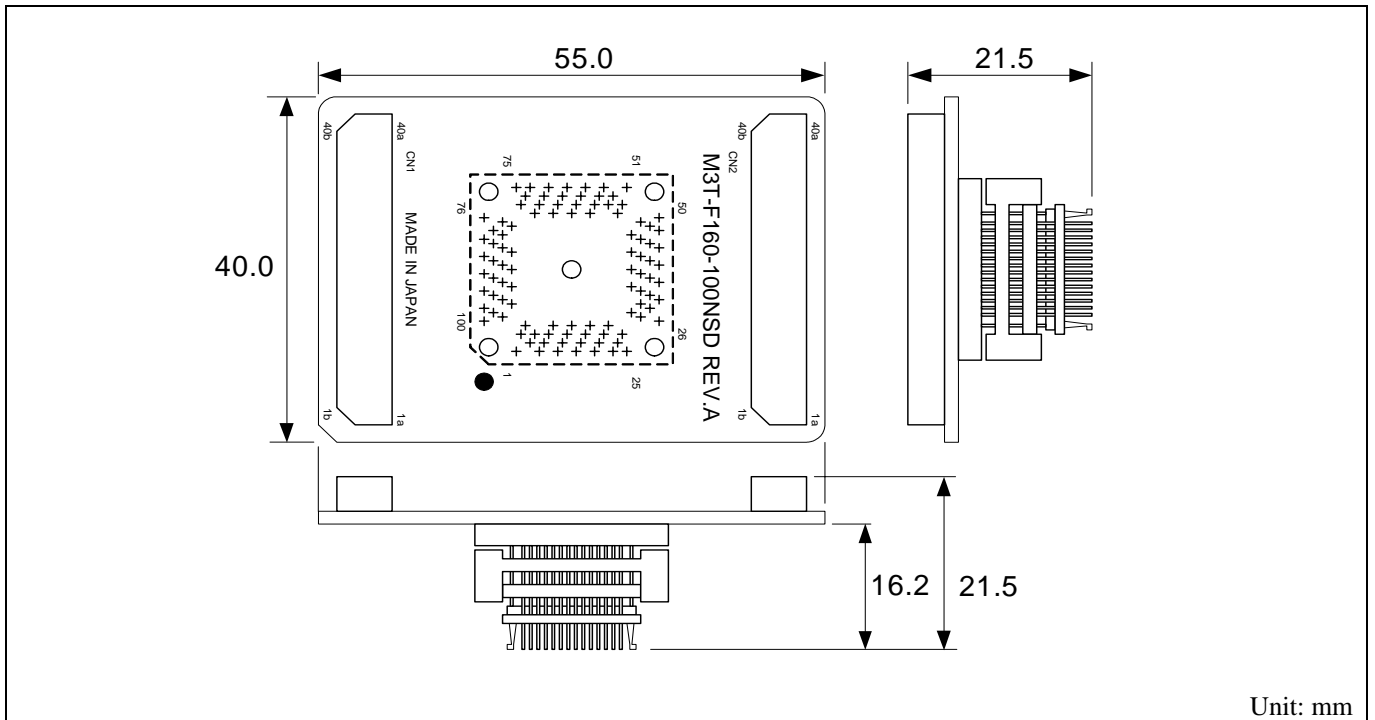


Figure 4.6 External dimensions of the M3T-F160-100NSD

4.4.4 External Dimensions of the M3T-FLX-144NSD

Figure 4.7 shows external dimensions of the converter board M3T-FLX-144NSD for a 144-pin LQFP (144P6Q).

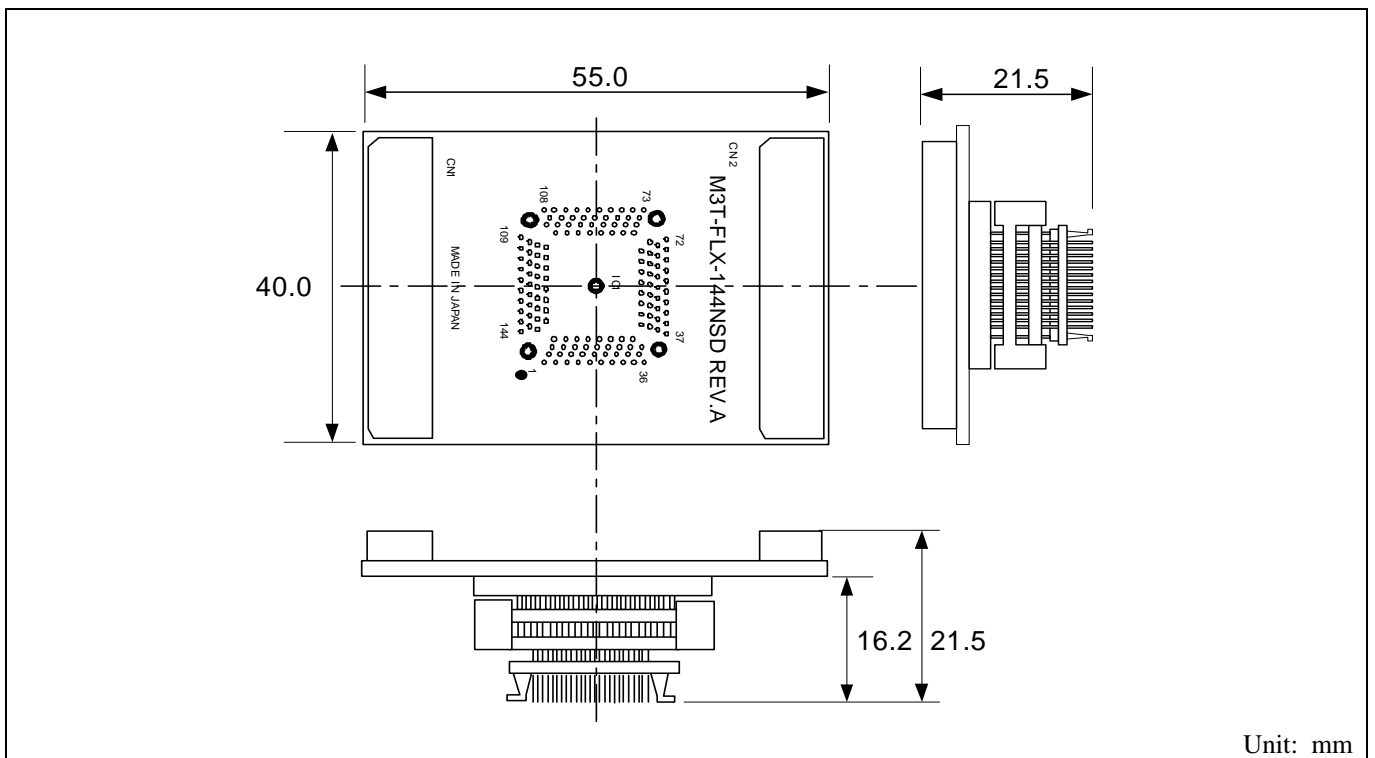


Figure 4.7 External dimensions of the M3T-FLX-144NSD

4.5 Notes on Using This Product

Notes on using this product are listed below. When debugging the MCU using this product, be careful about the following precautions.

IMPORTANT

Notes on the Self-check:

- If the self-check does not result normally (excluding target status errors), the emulator may be damaged. Then contact your local distributor.
- Run the self-check with the user system not connected.

Note on Quitting the Emulator Debugger:

- To restart the emulator debugger, always shut power to the emulator module off once and then on again.

Notes on Clock Supply to the MCU:

- A clock supplied to the evaluation MCU is selected by the Emulator tab in the Init dialog box of the emulator debugger.
 - (1) When "Internal" is selected:
A clock generated by the oscillator circuit board in the M30870T2-CPE is supplied to the evaluation MCU. The clock is continually supplied to the evaluation MCU regardless of a status of user system clock and a status of user program execution.
 - (2) When "External" is selected:
A clock generated by the oscillator in the user system is supplied. It depends on the status of the oscillation (on/off) of the user system.
- When operating this product with a sub clock, be sure to set the SW2 and SW3 to XCIN and NC, respectively.

Notes on Using the CPU Clock at Less than 10 MHz:

- To use the CPU clock at less than 10 MHz, execute the command shown below in the Script Window after starting the emulator debugger.


```
[Command]
_settimeout ,600
```

 Once this command is executed, it remains effective the next time you start the emulator debugger. Therefore, you do not need to execute this command again.
- When you use the CPU clock at less than 1 MHz, contact your local distributor.

Notes on Address-Match Interrupts:

- Do not single-step an address where an address-match interrupt occurs.
- When using an address-match interrupt, do not select the check box of "Enable the Address Match Interrupt Break Function" in the MCU tab of the Init dialog box. When not using an address-match interrupt, select the check box.
- When you use address-match breaks, if a low reset is input during a user program execution, a debug monitor program (about 100 cycles) is executed after a reset is released. Take note that it has effects on the user program execution time and the result of a trace.

IMPORTANT

Notes on EMEM Dialog Box:

Observe the following when setting up EMEM dialog box of the emulator debugger.

(1) Debug Monitor Bank Address

- When "E0" is specified, 64 KB of area starting from E00000h are allocated for use by the debug monitor.
- The 64 KB allocated for the debug monitor cannot be used.
- The below areas cannot be set for the debug monitor.
 - 1) MCU internal resources (ROM/RAM/SFR area)
 - 2) Multiplex area
 - 3) Interrupt vector area
- It is not possible to view or set the content of the specified area. Even on the memory window or in the reverse assemble area of the program/source windows, the content of this area is not displayed correctly though it can be displayed.

(2) Processor Mode

- Set a processor mode for the target MCU.
- To set single-chip mode or memory expansion mode, pin CNVSS used with MCU status must be "L". MCU status indicates pin level of the user system.
- To set memory expansion mode, pins RDY* and HOLD* used with MCU status must be "H".
- When the user system is not connected, all modes are available.

Notes on the Watchdog Function:

- When using the watchdog function, check the box of "Debug the program using the Watchdog Timer" in the MCU tab of the Init dialog box. When not using the watchdog function, do not check the box.
- If the reset circuit of the user system has a watchdog timer, disable it when using the emulator.

Notes on Debugging in CPU Rewrite Mode:

- To debug a program in CPU rewrite mode, check the box "Debug the program using the CPU Rewrite Mode" in the MCU tab of the Init dialog box. When you do not debug a program in CPU rewrite mode, uncheck the box.
- When you debug a program in CPU rewrite mode, the block 0 area (FFF000h--FFFFFFh) must not be rewritten. Otherwise, the emulator will be out of control.
- When debugging in CPU rewrite mode is enabled, you cannot use the following functions.
 - (1) Setting an address match breakpoint
 - (2) Setting a software breakpoint to the internal ROM area
 - (3) Executing COME to the internal ROM area
- Do not use the following functions to the rewrite control program area (from setting CPU rewrite mode select bit to releasing it). If any of these are used, malfunctions may occur (e.g. The emulator cannot shift to CPU rewrite mode or contents of ROM cannot be read out properly.).
 - (1) Single stepping
 - (2) Setting a software breakpoint
 - (3) Setting a hardware breakpoint
 - (4) Executing COME

IMPORTANT

Note on Software Breaks:

- A software break generates a break interruption by forcibly inserting a BRK instruction "08h" instead of an instruction code. Therefore, when referencing the result of a trace in bus mode, "08h" is displayed for the instruction fetch address where a software break is set.

Notes on Service-Life of the MCU's Internal Flash ROM:

- With the M30870T2-CPE, programs are downloaded to the MCU's flash ROM when debugging in single-chip mode or memory expansion mode. Because the number of write/erase cycles of this ROM is limited, the ROM must be replaced when at the end of its service-life.
- If the following errors occur frequently during program download, replace the MCU board.
 - Flash ROM erase error occurred ERROR (16258)
 - Flash ROM verify error occurred ERROR (16259)To purchase the product for replacement or request for repair, contact your local distributor.

Note on Voltage Detect Circuit:

- With the M30870T2-CPE, as the power voltage cannot be changed after powering on the user system, the voltage detect circuit (voltage down detect interrupt and hardware reset 2) cannot be used with this product.

Note on Protect Register:

- A protect is not canceled when protect register bit 2 (PRC2), which enables writing in the port P9 direction register and the function select register A3, is changed with the below procedure.
 - (1) Step execution of an instruction setting PRC2 to "1"
 - (2) Setting a break point from an instruction setting PRC2 to "1" to where the port P9 direction register or the function select register A3 is set
 - (3) Setting ("1") PRC2 from the dump window or script window during use program execution

Note on Memory Access:

- When setting memory expansion mode as a processor mode, it may be changed to memory expansion mode temporarily before the user program itself changes from single-chip mode to memory expansion mode. Take due consideration on this phenomenon in the following cases:
 - (1) Immediately before executing the program after setting a software break
 - (2) Immediately after stopping the program when a software break is set

IMPORTANT

Notes on A/D Conversion:

When selecting the MCU file "m30870_ad.mcu" in the Init dialog box of the emulator debugger to execute the A/D conversion debug, note the following.

- When setting the register below to use the analog input port selection function, you need to set the direction register of port P15 for a pin that performs A/D conversion to "input".

And you need to set the function selection register of port P15 for a pin that performs A/D conversion to "I/O port".

A/D0 control register 2 (address 394h)

b2,	b1	
1,	0	: AN00 to AN07
1,	1	: AN20 to AN27

Also, when the P0 group and P2 group are selected for A/D input, port P15 cannot be used as an I/O port. When setting the register above, port P15 cannot be used as an I/O port even if A/D conversion is halting.

For the switch SW5, refer to "2.9.1 Setting Switches of Emulator" (page 40).

- When setting the register below to use multi-port sweep mode, you need to set the direction register of port P15 for a pin that performs A/D conversion to "input".

And you need to set the function selection register of port P15 for a pin that performs A/D conversion to "I/O port".

A/D0 control register 4 (address 392h)

b3,	b2	
1,	0	: AN0 to AN7, AN00 to AN07
1,	1	: AN0 to AN7, AN20 to AN27

Also, when the P0 group and P2 group are used for multi-port sweep mode, port P15 cannot be use as an I/O port. When setting the register above, port P15 cannot be used as an I/O port even if A/D conversion is halting.

- Because a converter board and other devices are used between the evaluation MCU and the user system, the A/D converter operates differently from an actual MCU. Make the final evaluation of the A/D converter using an actual MCU.

IMPORTANT

Notes on MCU File:

Two types of MCU file are available for this product. Please use one of them as occasion demands.

(1) Using the MCU file "m30870.mcu"

When selecting AN00-AN07 or AN20-AN27 for analog input port select bits (bit2 and bit1 of 0394h), port P15 can be used as an I/O port and intelligent I/O pin. However, external trigger mode (ADtrg and three-phase timer B2) cannot be used. When using the "m30870.mcu", set all the SW5 switches of the M30870T-EPBM to "OFF".

(2) Using the MCU file "m30870_ad.mcu"

For external trigger mode, use the "m30870_ad.mcu".

In this case, set analog input port select bits (bit2 and bit1 of 0394h) as follows.

- To select AN0-AN7 or AN150-AN157 for analog input port select bits:

Set all the SW5 switches of the M30870T-EPBM to "ON".

- To select AN00-AN07 or AN20-AN27 for analog input port select bits:

Setting the SW5 switches of the M30870T-EPBM enables to set analog input pin by each individual pin.

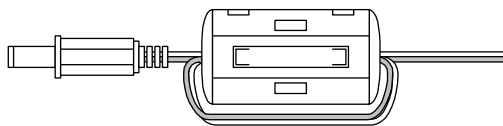
Set the pins used for the A/D conversion to ON and the pins not used to OFF.

Port P15 corresponding to a selected bit needs to be set to "input".

Notes on CE Declaration of Conformity:

- Please use this product with care as described below.
 - * Electrostatic Discharge Precautions must be taken when handling the product.
 - * Must not be used within 30 meters of a domestic radio or television receiver.
 - * For correct operation of this product, it is recommended that Mobile phones are not used within 10 meters of this product system.
 - * This product should be powered down when not in use.
- This product generates, uses, and can radiate radio frequency energy and may cause harmful interference to radio communications.
- If this product causes harmful interference to radio or television reception, which can be determined by turning this product off or on, you are encouraged to try to correct the interference by one or more of the following methods;
 - * Ensure attached cables do not lie across the probe board and converter board.
 - * Reorient the receiving antenna.
 - * Increase the distance between the product and the receiver.
 - * Connect the product into an outlet on a circuit different from that to which the receiver is connected.
 - * Consult the dealer or experienced radio/TV technician for help.
- Attach the ferrite core included with this product close to the DC plug of the power cable. Without the ferrite core it may cause interference.

The power cable should be wound around the ferrite core as shown in the figure, and close the ferrite core until it clicks.



5. Troubleshooting

This chapter describes how to troubleshoot when this product does not work properly.

5.1 Flowchart to Remedy the Troubles

Figure 5.1 shows the flowchart to remedy the troubles from when power to the emulator is activated until the emulator debugger starts up. Check this while the user system is disconnected. For the latest FAQs visit the Renesas Tools Homepage.

<http://www.renesas.com/en/tools>

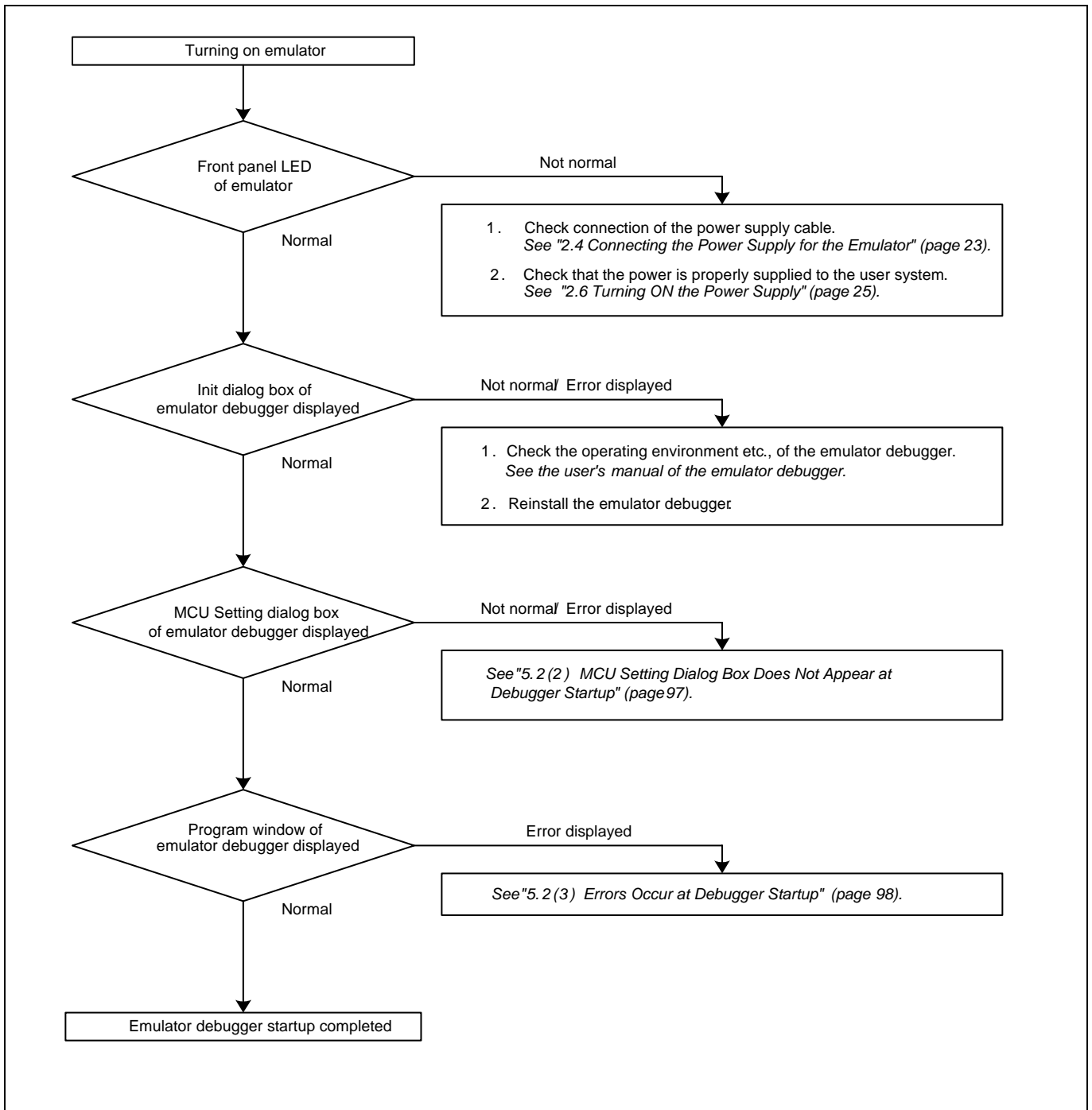


Figure 5.1 Flowchart to remedy the troubles

5.2 When the Emulator Debugger Does Not Start Up Properly

(1) When the LEDs of the M30870T2-CPE Do Not Display Normally

Table 5.1 Errors LEDs show and their checkpoints

Error	Connection to the user system	Checkpoint
LEDs do not light up.	-	Check that the power cable is connected. <i>See "2.4 Connecting the Power Supply for the Emulator" (page 23).</i>
Target Status POWER LED does not light up.	Connected	Check that power is properly supplied to the user system and that the user system is properly grounded.
Target Status CLOCK LED does not light up.	Not connected	(1) Check that both the main and sub clocks of the emulator debugger are not set to "EXT". <i>See the CLK command of the emulator debugger.</i> (2) Check that the oscillator circuit board is properly installed in the emulator and is oscillating. <i>See "2.9.2 Selecting Clock Supply" (page 47).</i>
	Connected	When the clock is supplied from an external oscillator, check that the oscillator circuit in the user system is oscillating properly.
Target Status RESET LED does not go out.	Connected	Check that the reset pin of the user system is pulled up.

(2) MCU Setting Dialog Box Does Not Appear at Debugger Startup

Table 5.2 Checkpoints of errors at debugger startup

Error	Checkpoint
Communication error occurred. Data was not sent to the target.	Check that the USB cable is connected properly. <i>See "2.5 Connecting the Host Machine" (page 24).</i>
Not compact emulator.	Check that an emulator other than the compact emulator (such as PC4701, PC7501) is not connected.
Target MCU is in the reset state.	(1) Check that the reset pin of the user system is pulled up. (2) Check that the reset pin of the user system has changed from Low to High level.
Target MCU cannot be reset.	(1) Check that pin NMI* is held High. (2) If the reset circuit of the user system has a watchdog timer, disable the timer. (3) Check that power is properly supplied to the user system and that the user system is properly grounded.
Target is in "HOLD" state.	The MCU is either in stop mode or wait mode. Either reset the MCU or cancel the mode with an interrupt. <i>See MCU specifications.</i>
Target clock is stopped.	When the clock is supplied from an external oscillator, check that the oscillator circuit in the user system is oscillating properly.
Target MCU is not receiving power.	Check that power is properly supplied to the user system and that the user system is properly grounded.

(3) Errors Occur at Debugger Startup

Table 5.3 Checkpoints of errors at debugger startup

Error	Checkpoint
Target MCU is uncontrollable.	<ol style="list-style-type: none">(1) Check that the NQPACK etc. mounted on the user system is soldered properly.(2) Check that the connector is installed properly to the user system.(3) Check that pin CNVSS is held Low.

5.3 How to Request for Support

After checking the items in "5 Troubleshooting", fill in the text file which is downloaded from the following URL, then send the information to your local distributor.

<http://tool-support.renesas.com/eng/toolnews/registration/support.txt>

For prompt response, please specify the following information:

(1) Operating environment

- Operating voltage: _____ [V]
- Operating frequency: _____ [MHz]
- Clock supply to the MCU: Internal oscillator/External oscillator

(2) Condition

- The emulator debugger starts up/does not start up
- The error is detected/not detected in the self-check
- Frequency of errors: always/frequency (_____)

(3) Problem

6. Maintenance and Guarantee

This chapter describes how to maintenance, repair provisions and how to request for repair.

6.1 User Registration

When you purchase our product, be sure register as a user. For user registration, refer to "User Registration" (page 12) of this user's manual.

6.2 Maintenance

- (1) If dust or dirt collects on any equipment of your emulation system, wipe it off with a dry soft cloth. Do not use thinner or other solvents because these chemicals can cause the equipment's surface coating to separate.
- (2) When you do not use this product for a long period, for safety purposes, disconnect the power cable from the power supply.

6.3 Guarantee

If your product becomes faulty within one year after its purchase while being used under good conditions by observing "IMPORTANT" and "Precautions for Safety" described in this user's manual, we will repair or replace your faulty product free of charge. Note, however, that if your product's fault is raised by any one of the following causes, we will repair it or replace it with new one with extra-charge:

- Misuse, abuse, or use under extraordinary conditions
- Unauthorized repair, remodeling, maintenance, and so on
- Inadequate user's system or misuse of it
- Fires, earthquakes, and other unexpected disasters

In the above cases, contact your local distributor. If your product is being leased, consult the leasing company or the owner.

6.4 Repair Provisions

(1) Repair with extra-charge

The products elapsed more than one year after purchase can be repaired with extra-charge.

(2) Replacement with extra-charge

If your product's fault falls in any of the following categories, the fault will be corrected by replacing the entire product instead of repair, or you will be advised to purchase new one, depending on the severity of the fault.

- Faulty or broken mechanical portions
- Flaw, separation, or rust in coated or plated portions
- Flaw or cracks in plastic portions
- Faults or breakage caused by improper use or unauthorized repair or modification
- Heavily damaged electric circuits due to overvoltage, overcurrent or shorting of power supply
- Cracks in the printed circuit board or burnt-down patterns
- Wide range of faults that makes replacement less expensive than repair
- Unlocatable or unidentified faults

(3) Expiration of the repair period

When a period of one year elapses after the model was dropped from production, repairing products of the model may become impossible.

(4) Transportation fees at sending your product for repair

Please send your product to us for repair at your expense.

6.5 How to Make Request for Repair

If your product is found faulty, fill in a Repair Request Sheet downloadable from the following URL. And email the sheet and send the product to your local distributor.

<http://www.renesas.com/repair>

CAUTION

Note on Transporting the Product:

- When sending your product for repair, use the packing box and cushion material supplied with this product when delivered to you and specify handling caution for it to be handled as precision equipment. If packing of your product is not complete, it may be damaged during transportation. When you pack your product in a bag, make sure to use conductive polyvinyl supplied with this product (usually a blue bag). When you use other bags, they may cause a trouble on your product because of static electricity.

[MEMO]

Compact Emulator for M32C/87 Group
M30870T2-CPE User's Manual

Publication Date: Aug. 31, 2009 Rev.5.00

Published by: Sales Strategic Planning Div.
Renesas Technology Corp.

Edited by: Microcomputer Tool Development Department
Renesas Solutions Corp.

M30870T2-CPE
User's Manual



Renesas Electronics Corporation

1753, Shimonumabe, Nakahara-ku, Kawasaki-shi, Kanagawa 211-8668 Japan

REJ10J0766-0500(T)