

# HA13164AH

## Multiple Voltage Regulator for Car Audio

REJ03F0139-0200

Rev.2.00

Jan 16, 2007

---

### Description

The HA13164AH is a compact multiple voltage regulator for car audio system. The outputs of this IC output consist of regulated 5.7 V output for a microcontroller, regulated 8 V output for CD driver, regulated 9.0 V output for audio control, regulated 10 V output for illuminations and regulated 5 V output, VCC-dependent output for external output and VCC-dependent output for remote-ANT.

### Functions

#### General

- ACC power monitor circuit is built-in as to detect low voltage.
- Low saturation output (PNP output) used for audio output.
- Adjustable voltage for illumination output by changing an external resistor.

#### Protections

- Output current limit circuit to avoid device destruction caused by shorted output, etc.
- High surge input protector against VCC and ACC.
- Built in a thermal shutdown circuit to prevent against the thermal destruction.

EOL announced Product

Pin Description and Equivalent Circuit

Pin No.	Pin Name	Specification	Equivalent Circuit	Function		
				Normal Operation	TSD	Surge Input
1	EXT OUT	VCC-1 V/300 mA min		Output voltage is VCC-1 V when M or H level applied to CTRL pin.	0 V	0 V
2	ANT OUT	VCC-1 V/300 mA min		Output voltage is VCC-1 V when M or H level to CTRL pin and H level to ANT-CTRL.	0 V	0 V
3	ACC IN	—		Connected to ACC.	—	—
4	VDD OUT	5.7 V/100 mA min		Regular 5.7 V.	5.7 V	0 V
5	SW5V OUT	5.0 V/100 mA min		Output voltage is 5 V when M or H level applied to CTRL pin.	0 V	0 V
6	COMP OUT	5.0 V/100 mA min		Output for ACC detector	0 V	0 V
7	ANT CTRL	—		L: ANT output OFF H: ANT output ON	—	—
8	VCC	—		Connected to VCC	—	—

## Pin Description and Equivalent Circuit (cont.)

Pin No.	Pin Name	Specification	Equivalent Circuit	Function		
				Normal Operation	TSD	Surge Input
9	BATT DET	—		Low battery detect.	Detect	Not detect
10	AUDIO OUT	9.0 V/500 mA min		Output voltage is 9 V when M or H level applied to CTRL pin.	0 V	0 V
11	CTRL	—		L: BIAS OFF M: BIAS ON H: CD ON	—	—
12	CD OUT	8.0 V/1.3 A min		Output voltage is 8 V when H level applied to CTRL pin.	0 V	0 V
13	ILM AJ	—		Adjustment pin for ILM output voltage.	—	—
14	ILM OUT	9.85 V/500 mA min		Output voltage is 10 V when M or H level applied to CTRL pin	0 V	0 V
15	GND	—		Connected to GND	—	—

Timing Chart

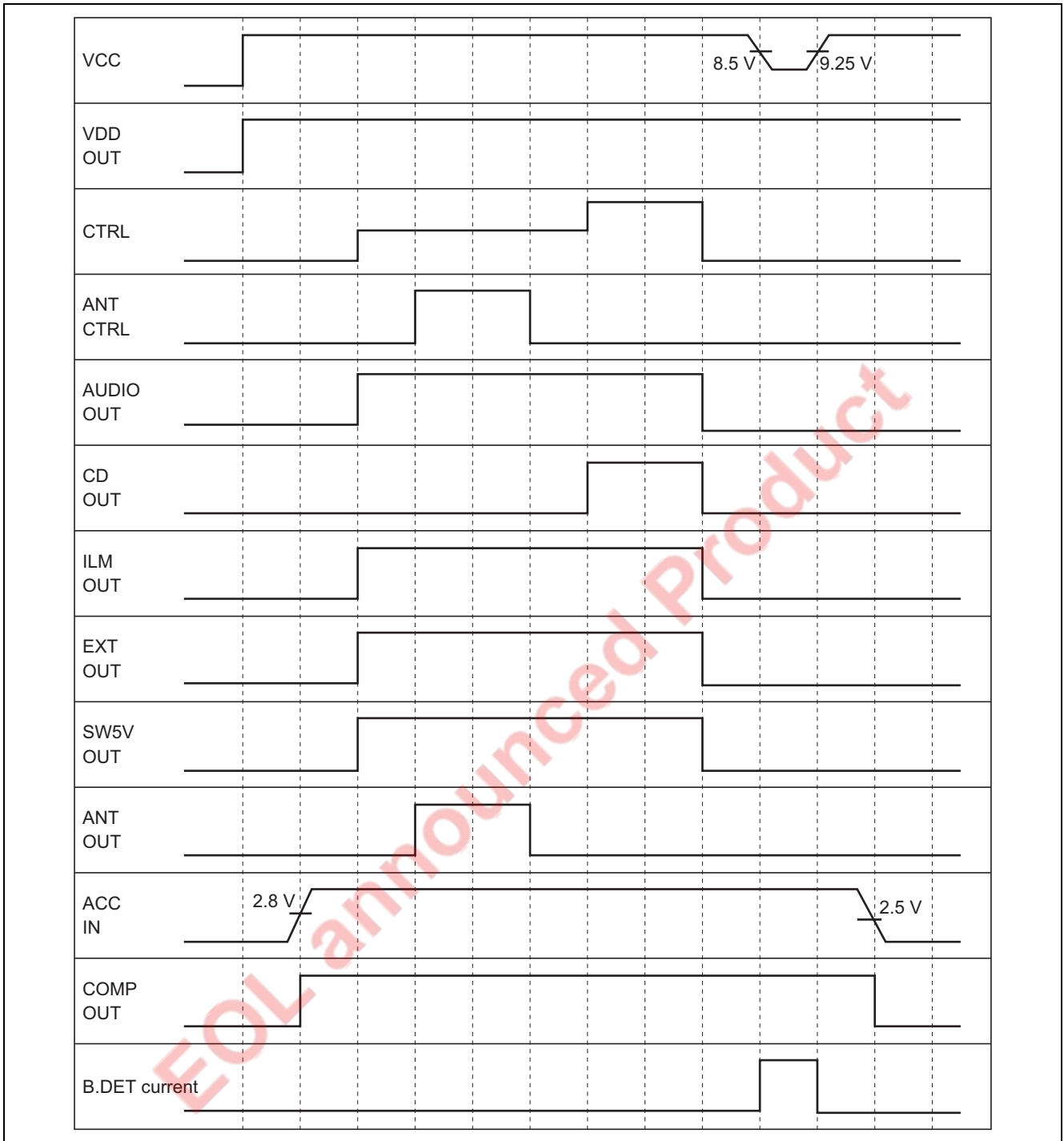

Block Diagram

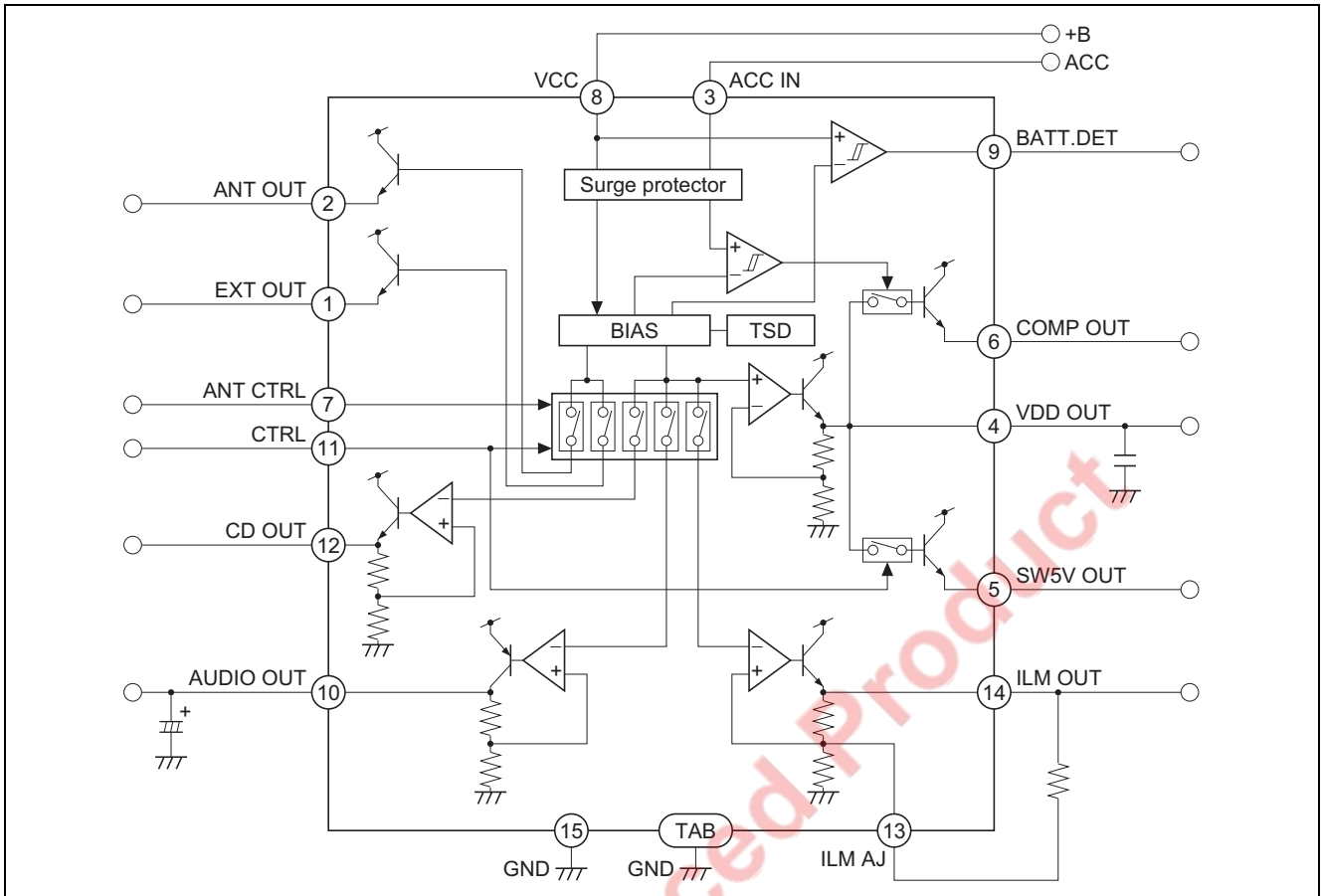

**Absolute Maximum Ratings**

(Ta = 25°C)

Item	Symbol	Rating	Unit	Note
Operating power supply voltage	Vcc	18	V	
DC supply voltage	Vcc(DC)	26	V	1
Peak voltage	Vcc(PEAK)	50	V	2
Power dissipation	Pd	36	W	3
Junction temperature	Tj	150	°C	
Operating temperature	Topr	-40 to +85	°C	
Storage temperature	Tstg	-55 to +125	°C	

Notes: Recommended power supply voltage range 10 to 16 V.

1. Applied time is less than 30 s.
2. Surge pulse as input.
3. Ta = 25°C. : Permissible power dissipation when using a heat sink of infinite area. Refer to the derating curves below.

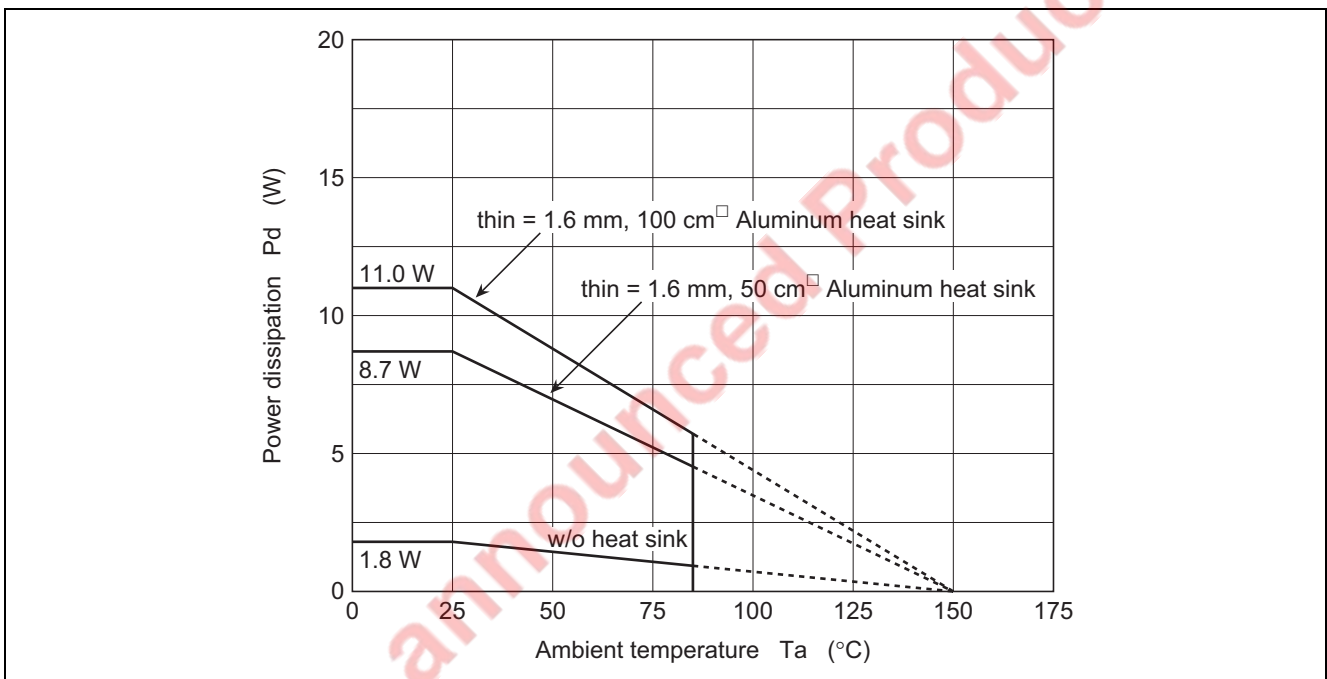

## Electrical Characteristics

(unless otherwise noted,  $V_{CC} = 13.2\text{ V}$ ,  $T_a = 25^\circ\text{C}$ )

Item		Symbol	Min	Typ	Max	Unit	Test Condition
Standby current		IST	—	460	700	$\mu\text{A}$	ACC = 0 V, CTRL = 0 V
CTRL L level (STBY mode)		VCL	0	—	1.0	V	
CTRL M level (CD OFF mode)		VCM	2.0	—	3.0	V	
CTRL H level (CD ON mode)		VCH	4.0	—	—	V	
ANT CTRL L level (ANT OFF mode)		VACL	0	—	2.0	V	
ANT CTRL H level (ANT ON mode)		VACH	3.0	—	—	V	
VDD OUT	Output voltage	Vo1	5.4	5.7	6.0	V	Io1 = 80 mA
	Voltage regulation	$\Delta\text{Vo}11$	—	10	50	mV	$V_{CC} = 10$ to 16 V, Io1 = 80 mA
	Load regulation	$\Delta\text{Vo}12$	—	50	100	mV	Io1 = 0 to 80 mA
	Minimum I/O voltage differential	$\Delta\text{Vo}13$	—	1.0	1.5	V	Io1 = 80 mA
	Output current capacity	Io1	100	250	—	mA	Vo1 $\geq$ 5.4 V
	Ripple rejection ratio	SVR1	50	60	—	dB	f = 100 Hz, Io1 = 80 mA
CD OUT	Output voltage	Vo2	7.6	8.0	8.4	V	Io2 = 1.0 A
	Voltage regulation	$\Delta\text{Vo}21$	—	40	100	mV	$V_{CC} = 10$ to 16V, Io2 = 1.0 A
	Load regulation	$\Delta\text{Vo}22$	—	70	150	mV	Io2 = 10m to 1.0 A
	Minimum I/O voltage differential	$\Delta\text{Vo}23$	—	1.0	1.5	V	Io2 = 1.0 A
	Output current capacity	Io2	1.3	2.0	—	A	Vo2 $\geq$ 7.6 V
	Ripple rejection ratio	SVR2	40	45	—	dB	f = 100 Hz, Io2 = 1.0 A
AUDIO OUT	Output voltage	Vo3	8.5	9.0	9.5	V	Io3 = 400 mA
	Voltage regulation	$\Delta\text{Vo}31$	—	30	90	mV	$V_{CC} = 10$ to 16 V, Io3 = 400 mA
	Load regulation	$\Delta\text{Vo}32$	—	100	200	mV	Io3 = 10 to 400 mA
	Minimum I/O voltage differential	$\Delta\text{Vo}33$	—	0.4	0.9	V	Io3 = 400 mA
	Output current capacity	Io3	500	850	—	mA	Vo3 $\geq$ 8.5 V
	Ripple rejection ratio	SVR3	45	50	—	dB	f = 100 Hz, Io3 = 400 mA
ILM OUT	Output voltage	Vo4	9.35	9.85	10.35	V	Io4 = 400 mA
	Voltage regulation	$\Delta\text{Vo}41$	—	40	100	mV	$V_{CC} = 12.5$ to 16 V, Io4 = 400 mA
	Load regulation	$\Delta\text{Vo}42$	—	50	100	mV	Io4 = 10 to 400 mA
	Minimum I/O voltage differential	$\Delta\text{Vo}43$	—	1.0	1.5	V	Io4 = 400 mA
	Output current capacity	Io4	500	900	—	mA	Vo4 $\geq$ 9.35 V
	Ripple rejection ratio	SVR4	35	40	—	dB	f = 100 Hz, Io4 = 400 mA
EXT OUT	Differential I/O voltage	$\Delta\text{Vo}51$	—	1.0	1.5	V	Io5 = 300 mA
	Load regulation	$\Delta\text{Vo}52$	—	350	600	mV	Io5 = 10 to 300 mA
	Output current capacity	Io5	300	500	—	mA	Vo5 $\geq$ 11.7 V
ANT OUT	Differential I/O voltage	$\Delta\text{Vo}61$	—	1.0	1.5	V	Io6 = 300 mA
	Load regulation	$\Delta\text{Vo}62$	—	350	600	mV	Io6 = 10 to 300 mA
	Output current capacity	Io6	300	500	—	mA	Vo6 $\geq$ 11.7 V
SW5V OUT	Output voltage	Vo7	4.6	5.0	5.4	V	Io7 = 80 mA, VDD = no load
	Output current capacity	Io7	100	300	—	mA	Vo7 $\geq$ 4.6 V
ACC OUT	Output voltage	Vo8	4.6	5.0	5.4	V	Io8 = 40 mA, VDD = no load
	Output current capacity	Io8	100	300	—	mA	Vo8 $\geq$ 4.6 V
	Rise threshold voltage	VTHH8	2.6	2.8	3.0	V	
	Hysteresis range	$\Delta\text{VTH}8$	0.2	0.3	0.4	V	
BATT. DET	Threshold voltage	VTHH9	8.1	8.5	8.9	V	
	Hysteresis range	$\Delta\text{VTH}9$	0.55	0.75	0.95	V	
	Output current capacity	Io9	200	—	—	$\mu\text{A}$	Vo = 0.3 V

Evaluation Circuit

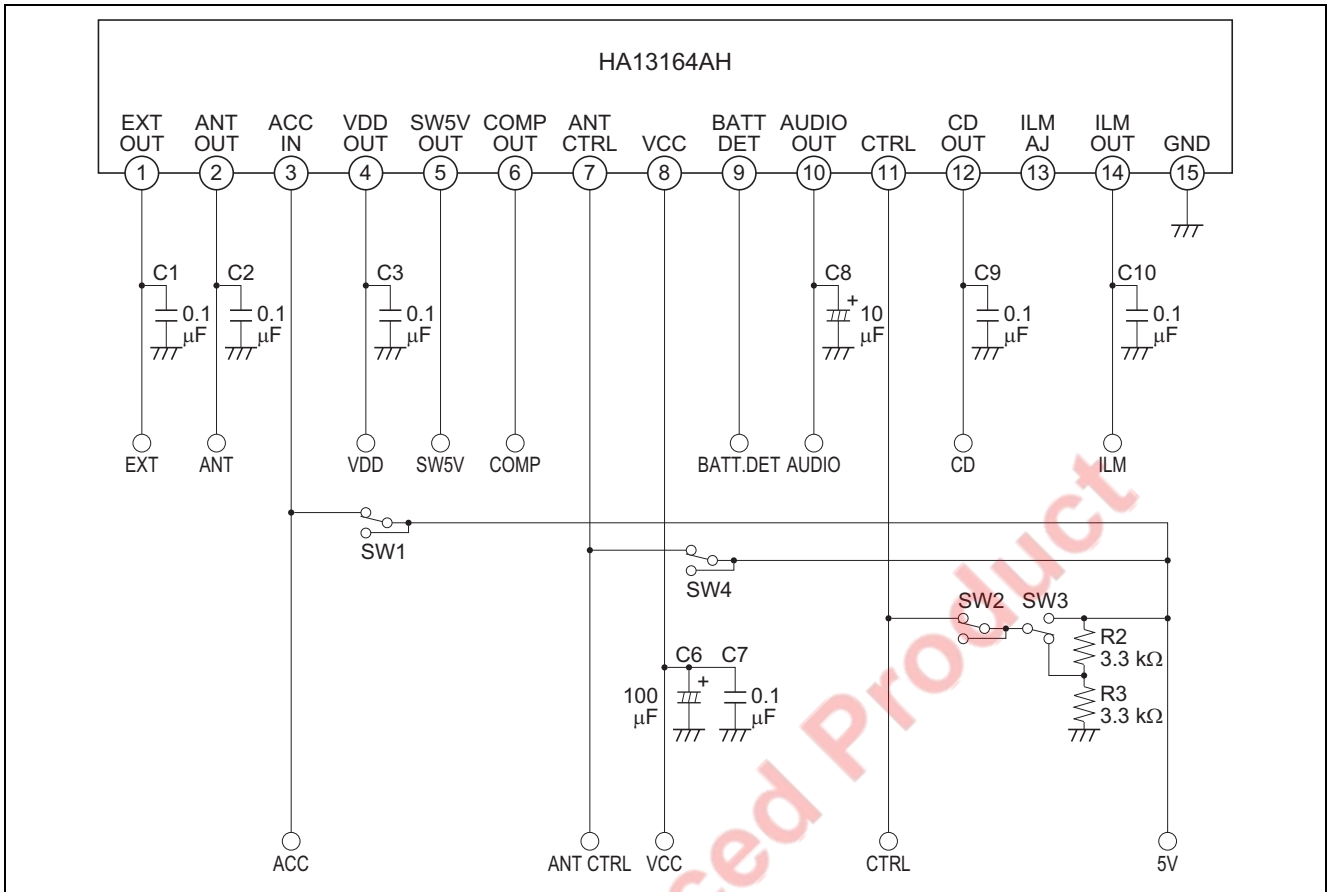

Main Characteristic

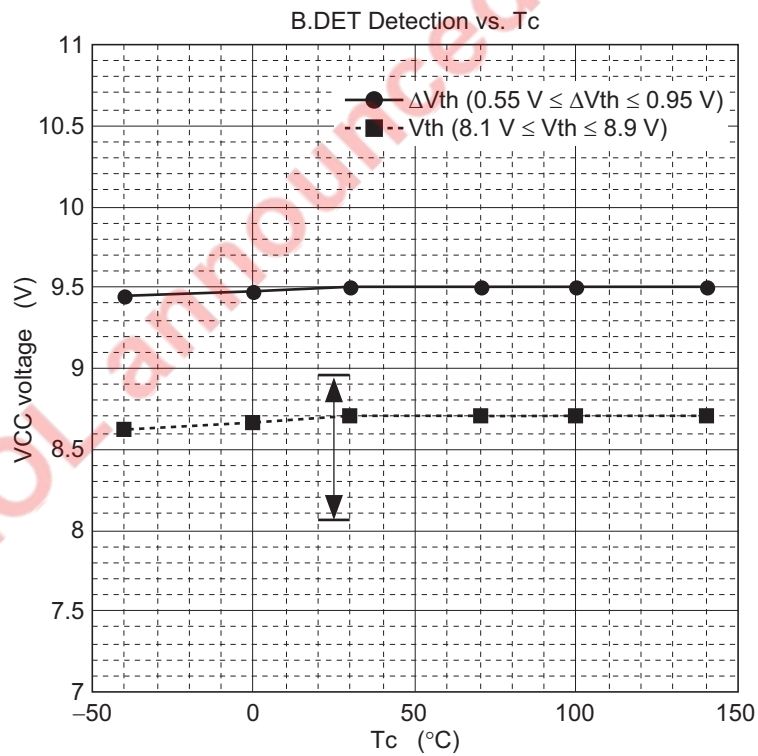
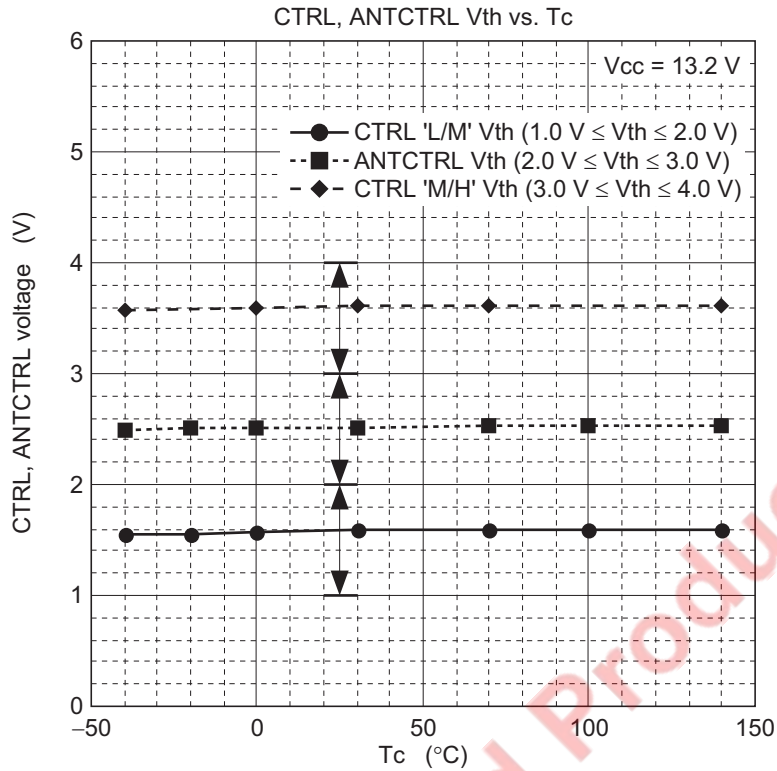

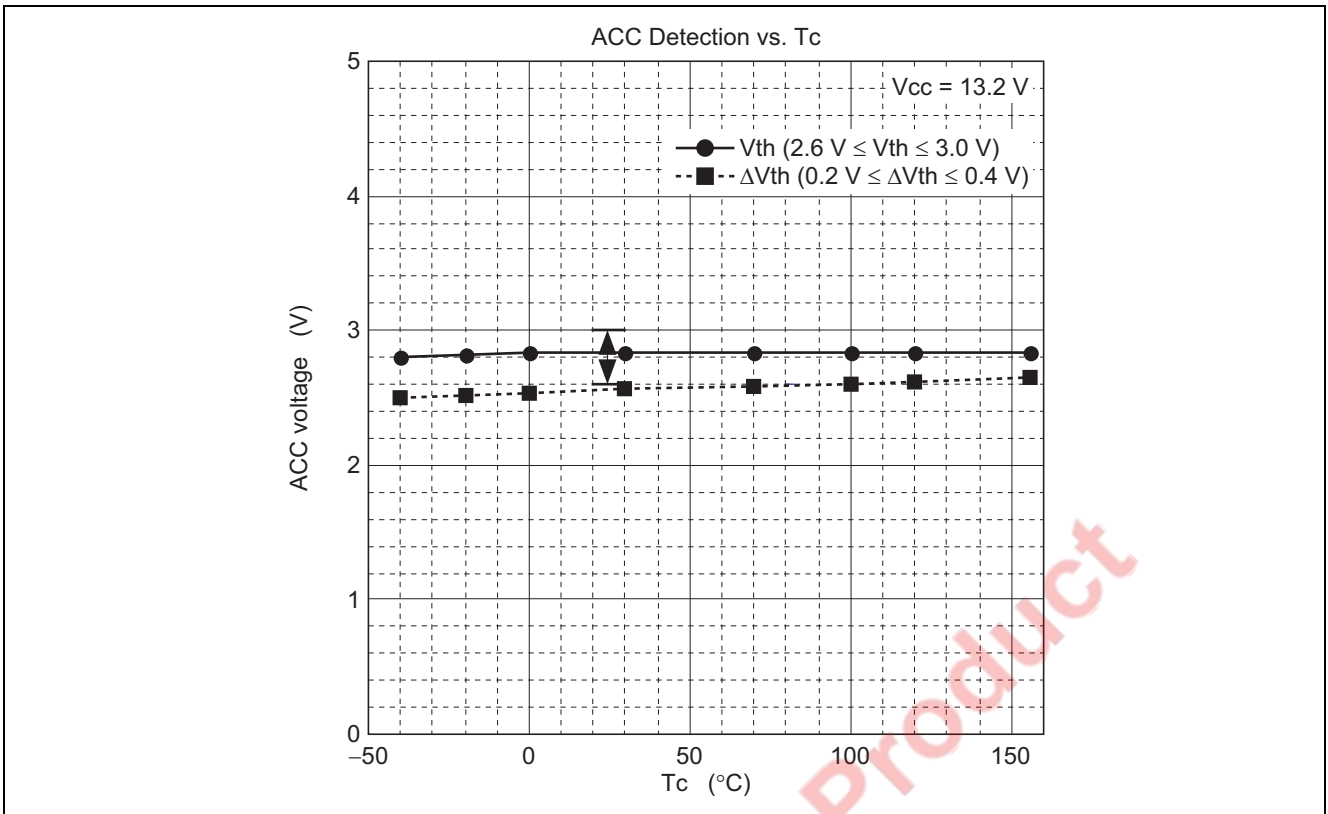

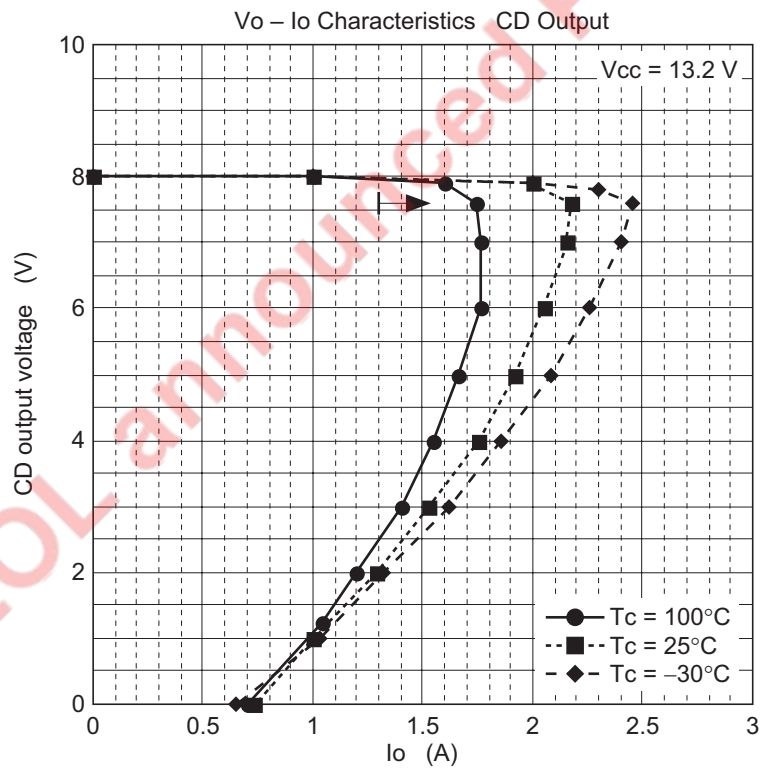
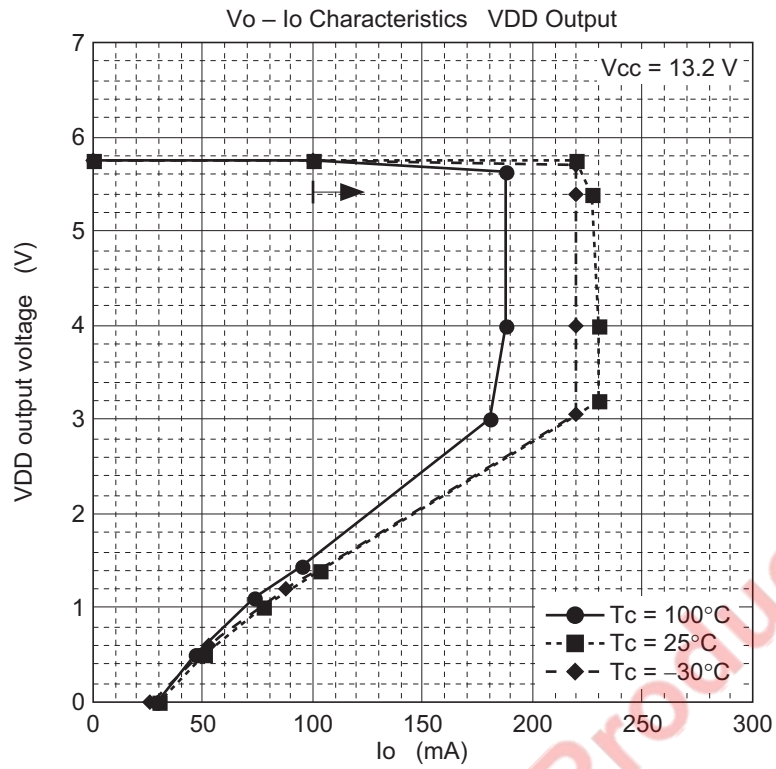

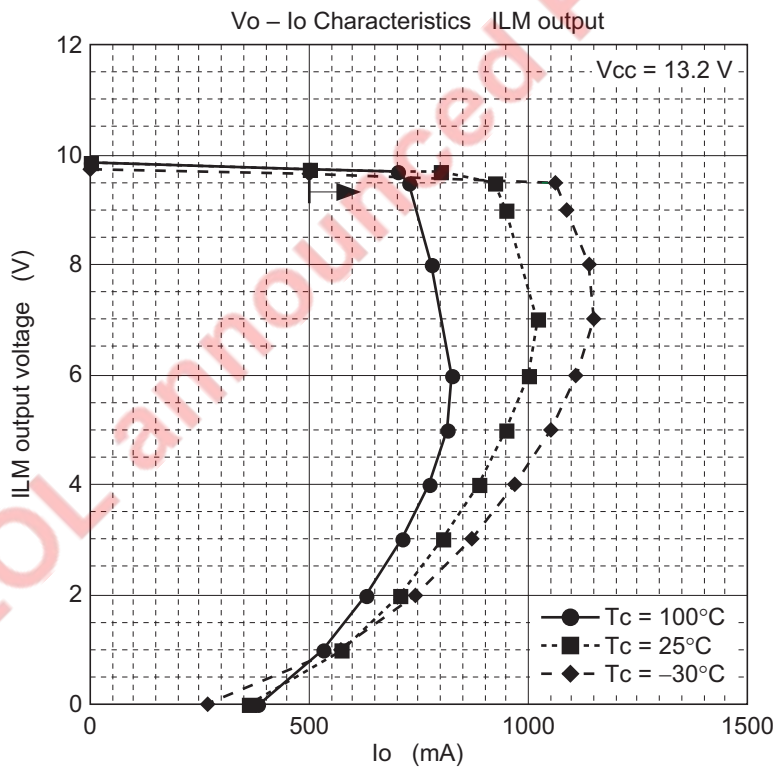
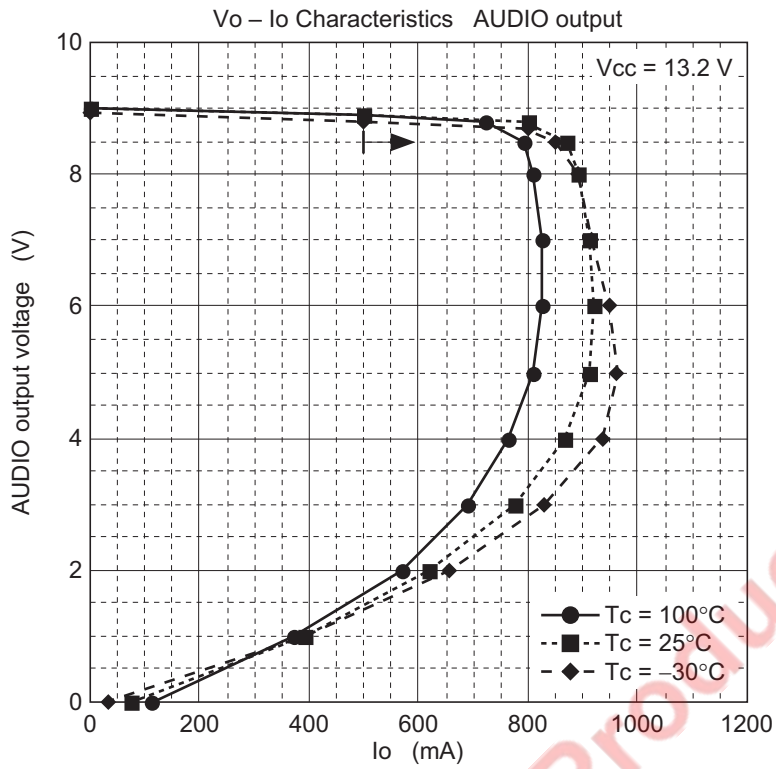

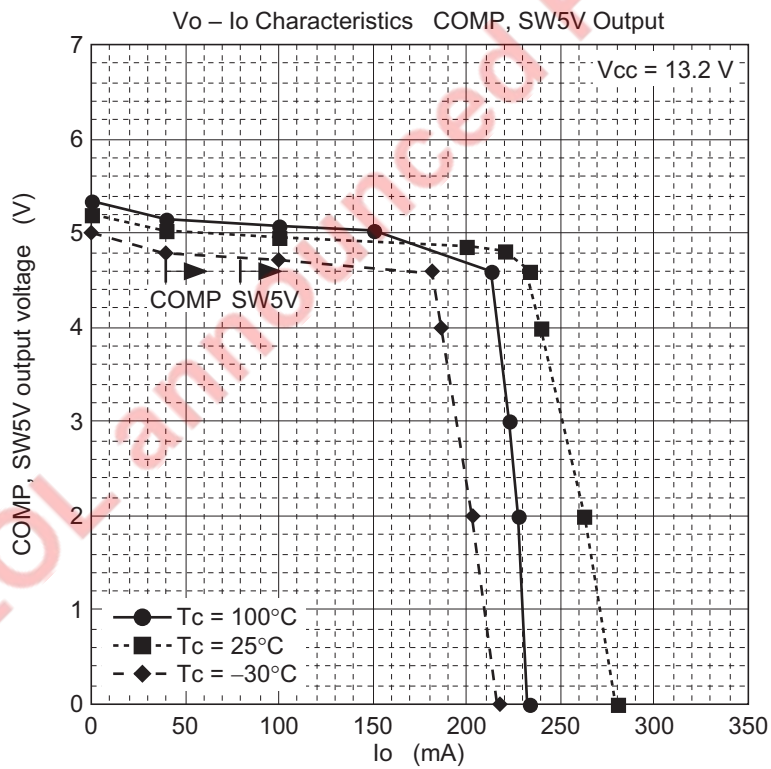
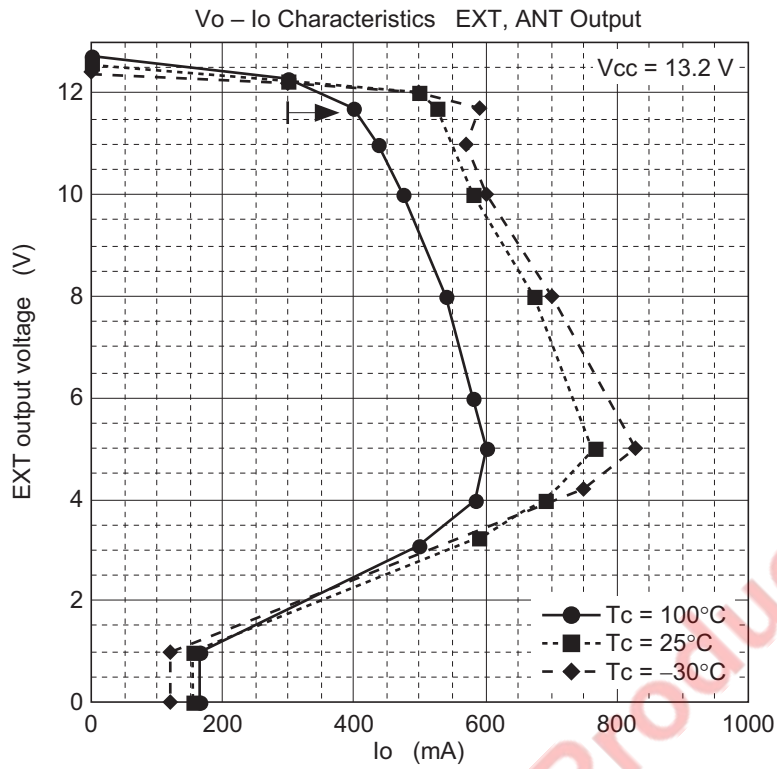

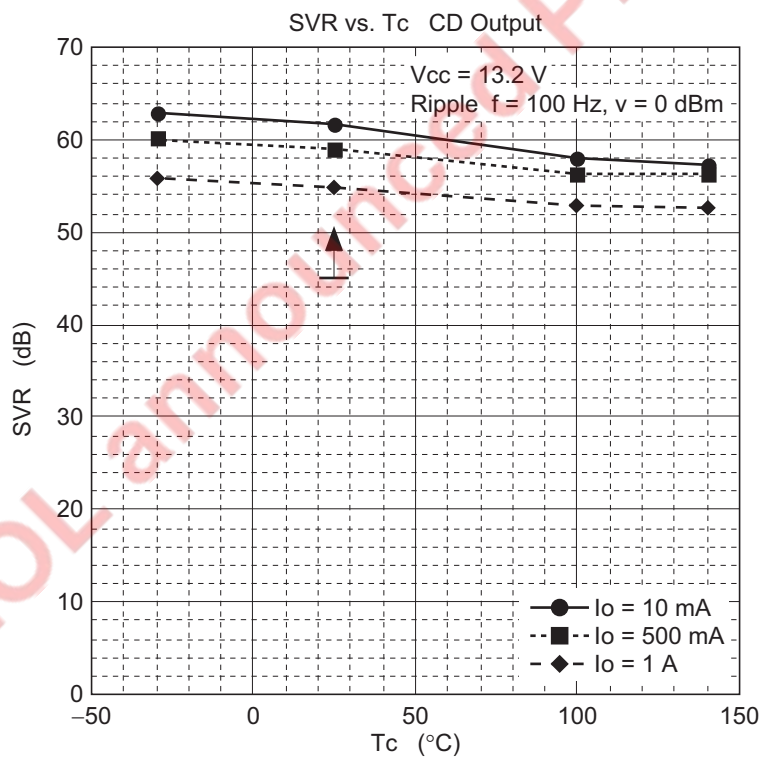
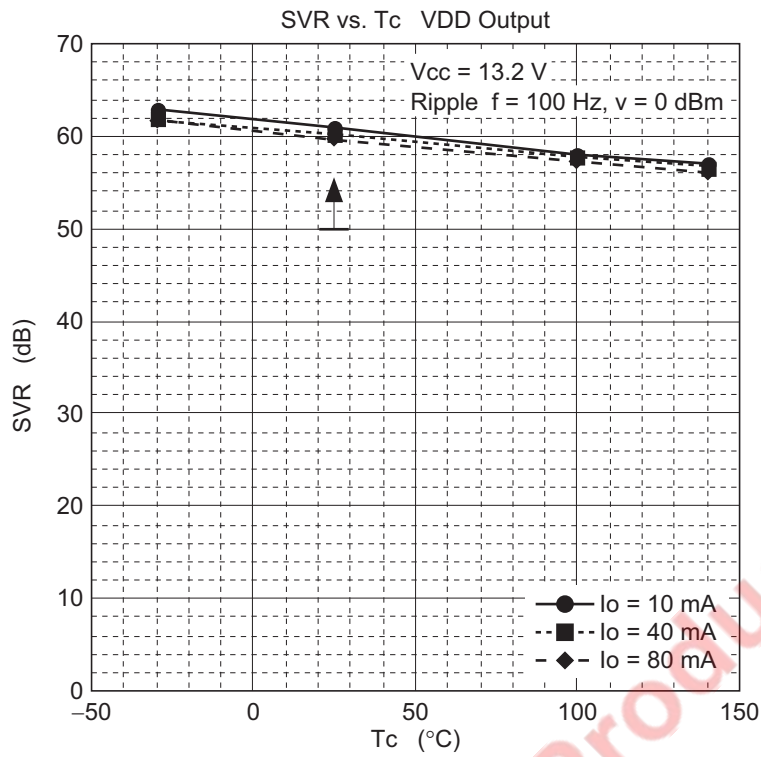

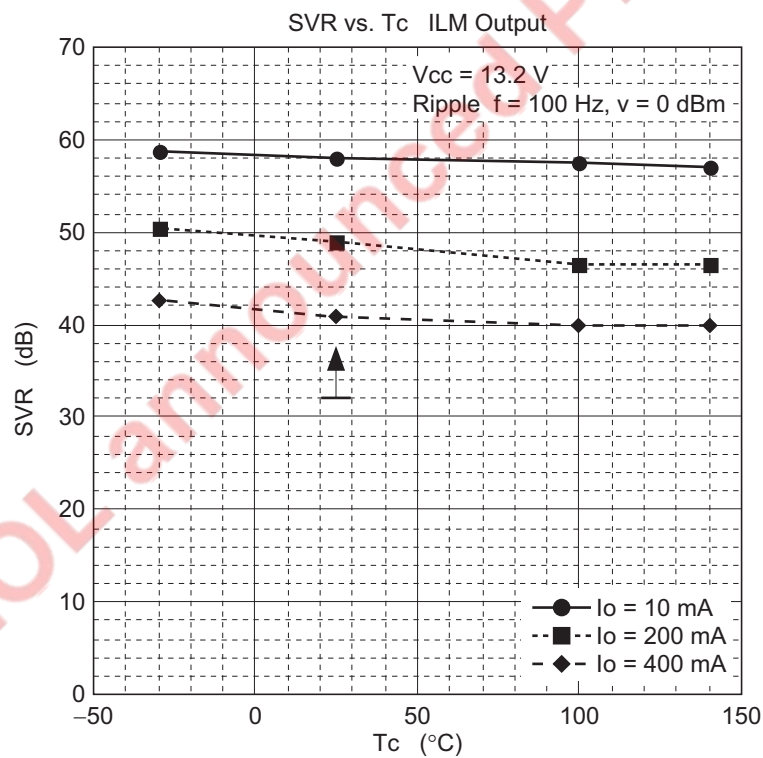
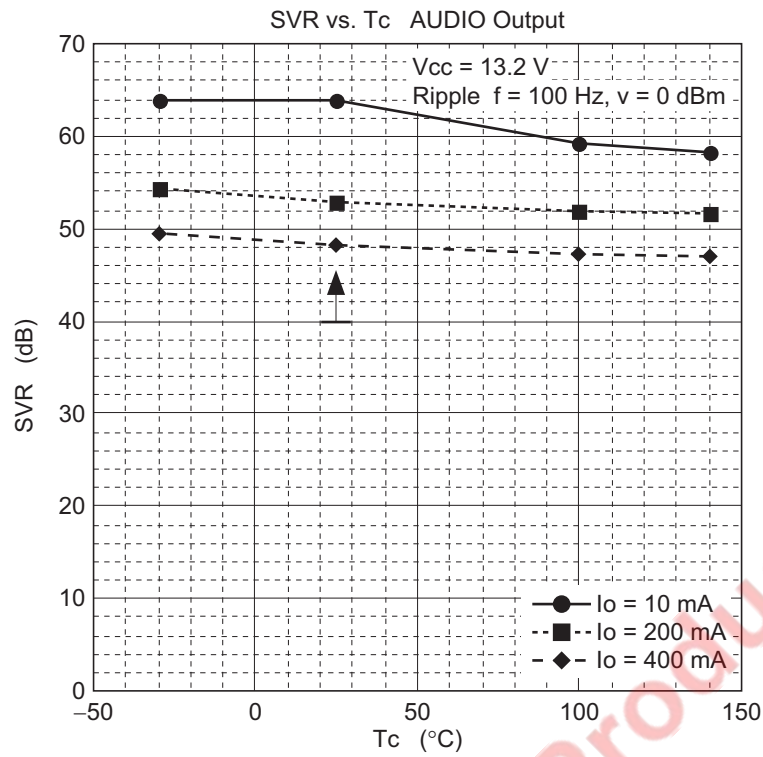

Package Dimensions

JEITA Package Code	RENESAS Code	Previous Code	MASS[Typ.]
P-HSIP15-14.3x19.66-1.27	PRSS0015DA-C	SP-15TGV	3.0g

Unit : mm

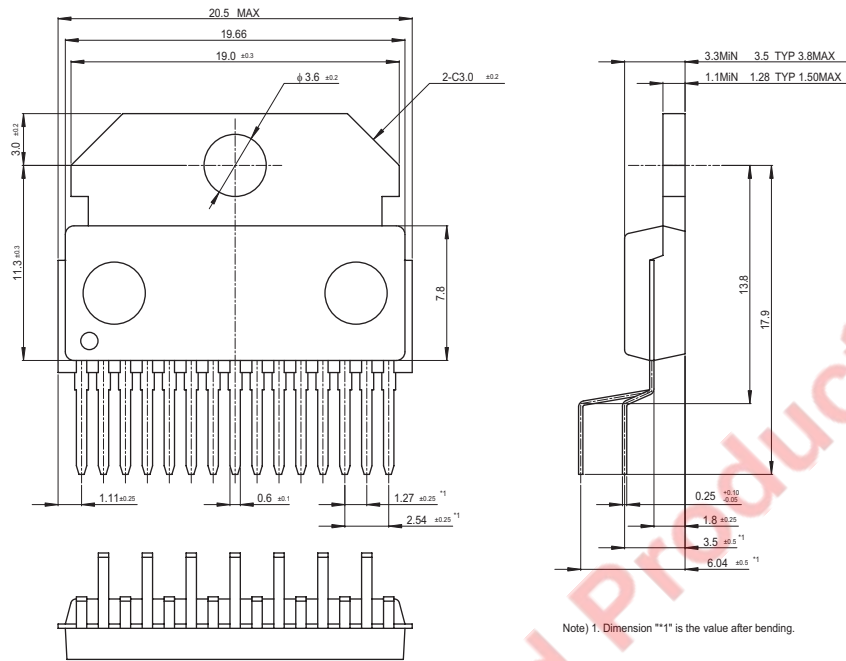

Note) 1. Dimension "\*" is the value after bending.

(NiPd/Au plating)

EOL announced Product

Notes:

1. This document is provided for reference purposes only so that Renesas customers may select the appropriate Renesas products for their use. Renesas neither makes warranties or representations with respect to the accuracy or completeness of the information contained in this document nor grants any license to any intellectual property rights or any other rights of Renesas or any third party with respect to the information in this document.
2. Renesas shall have no liability for damages or infringement of any intellectual property or other rights arising out of the use of any information in this document, including, but not limited to, product data, diagrams, charts, programs, algorithms, and application circuit examples.
3. You should not use the products or the technology described in this document for the purpose of military applications such as the development of weapons of mass destruction or for the purpose of any other military use. When exporting the products or technology described herein, you should follow the applicable export control laws and regulations, and procedures required by such laws and regulations.
4. All information included in this document such as product data, diagrams, charts, programs, algorithms, and application circuit examples, is current as of the date this document is issued. Such information, however, is subject to change without any prior notice. Before purchasing or using any Renesas products listed in this document, please confirm the latest product information with a Renesas sales office. Also, please pay regular and careful attention to additional and different information to be disclosed by Renesas such as that disclosed through our website. (<http://www.renesas.com>)
5. Renesas has used reasonable care in compiling the information included in this document, but Renesas assumes no liability whatsoever for any damages incurred as a result of errors or omissions in the information included in this document.
6. When using or otherwise relying on the information in this document, you should evaluate the information in light of the total system before deciding about the applicability of such information to the intended application. Renesas makes no representations, warranties or guaranties regarding the suitability of its products for any particular application and specifically disclaims any liability arising out of the application and use of the information in this document or Renesas products.
7. With the exception of products specified by Renesas as suitable for automobile applications, Renesas products are not designed, manufactured or tested for applications or otherwise in systems the failure or malfunction of which may cause a direct threat to human life or create a risk of human injury or which require especially high quality and reliability such as safety systems, or equipment or systems for transportation and traffic, healthcare, combustion control, aerospace and aeronautics, nuclear power, or undersea communication transmission. If you are considering the use of our products for such purposes, please contact a Renesas sales office beforehand. Renesas shall have no liability for damages arising out of the uses set forth above.
8. Notwithstanding the preceding paragraph, you should not use Renesas products for the purposes listed below:
  - (1) artificial life support devices or systems
  - (2) surgical implantations
  - (3) healthcare intervention (e.g., excision, administration of medication, etc.)
  - (4) any other purposes that pose a direct threat to human lifeRenesas shall have no liability for damages arising out of the uses set forth in the above and purchasers who elect to use Renesas products in any of the foregoing applications shall indemnify and hold harmless Renesas Technology Corp., its affiliated companies and their officers, directors, and employees against any and all damages arising out of such applications.
9. You should use the products described herein within the range specified by Renesas, especially with respect to the maximum rating, operating supply voltage range, movement power voltage range, heat radiation characteristics, installation and other product characteristics. Renesas shall have no liability for malfunctions or damages arising out of the use of Renesas products beyond such specified ranges.
10. Although Renesas endeavors to improve the quality and reliability of its products, IC products have specific characteristics such as the occurrence of failure at a certain rate and malfunctions under certain use conditions. Please be sure to implement safety measures to guard against the possibility of physical injury, and injury or damage caused by fire in the event of the failure of a Renesas product, such as safety design for hardware and software including but not limited to redundancy, fire control and malfunction prevention, appropriate treatment for aging degradation or any other applicable measures. Among others, since the evaluation of microcomputer software alone is very difficult, please evaluate the safety of the final products or system manufactured by you.
11. In case Renesas products listed in this document are detached from the products to which the Renesas products are attached or affixed, the risk of accident such as swallowing by infants and small children is very high. You should implement safety measures so that Renesas products may not be easily detached from your products. Renesas shall have no liability for damages arising out of such detachment.
12. This document may not be reproduced or duplicated, in any form, in whole or in part, without prior written approval from Renesas.
13. Please contact a Renesas sales office if you have any questions regarding the information contained in this document, Renesas semiconductor products, or if you have any other inquiries.



**RENESAS SALES OFFICES**

<http://www.renesas.com>

Refer to "<http://www.renesas.com/en/network>" for the latest and detailed information.

**Renesas Technology America, Inc.**

450 Holger Way, San Jose, CA 95134-1368, U.S.A  
Tel: <1> (408) 382-7500, Fax: <1> (408) 382-7501

**Renesas Technology Europe Limited**

Dukes Meadow, Millboard Road, Bourne End, Buckinghamshire, SL8 5FH, U.K.  
Tel: <44> (1628) 585-100, Fax: <44> (1628) 585-900

**Renesas Technology (Shanghai) Co., Ltd.**

Unit 204, 205, AZIACenter, No.1233 Lujiazui Ring Rd, Pudong District, Shanghai, China 200120  
Tel: <86> (21) 5877-1818, Fax: <86> (21) 6887-7898

**Renesas Technology Hong Kong Ltd.**

7th Floor, North Tower, World Finance Centre, Harbour City, 1 Canton Road, Tsimshatsui, Kowloon, Hong Kong  
Tel: <852> 2265-6688, Fax: <852> 2730-6071

**Renesas Technology Taiwan Co., Ltd.**

10th Floor, No.99, Fushing North Road, Taipei, Taiwan  
Tel: <886> (2) 2715-2888, Fax: <886> (2) 2713-2999

**Renesas Technology Singapore Pte. Ltd.**

1 Harbour Front Avenue, #06-10, Keppel Bay Tower, Singapore 098632  
Tel: <65> 6213-0200, Fax: <65> 6278-8001

**Renesas Technology Korea Co., Ltd.**

Kukje Center Bldg. 18th Fl., 191, 2-ka, Hangang-ro, Yongsan-ku, Seoul 140-702, Korea  
Tel: <82> (2) 796-3115, Fax: <82> (2) 796-2145

**Renesas Technology Malaysia Sdn. Bhd**

Unit 906, Block B, Menara Amcorp, Amcorp Trade Centre, No.18, Jalan Persiaran Barat, 46050 Petaling Jaya, Selangor Darul Ehsan, Malaysia  
Tel: <603> 7955-9390, Fax: <603> 7955-9510